

MODERN WIRELESS



August.

1/6

Vol. 1. No. 7.

Edited by JOHN SCOTT-TAGGART, F.Inst.P., Member I.R.E.

August, 1923.



No. 7

A New Method of Amplification. *By John Scott-Taggart, F.Inst.P.*
Practical Details of Another Dual Amplification Receiver.

By Percy W. Harris.

Undesirable Noises in Valve Sets.—How to Eliminate them.

By John Scott-Taggart, F.Inst.P.

How to Build a Power Amplifier. *By G. P. Kendall, B.Sc.*

A Simple Crystal Receiver Apparatus.

Practical Articles on Measuring Wireless Quantities.

Hints on Building

Notes on Crystals.

Hints for the Beginner.

Apparatus we have Tested.

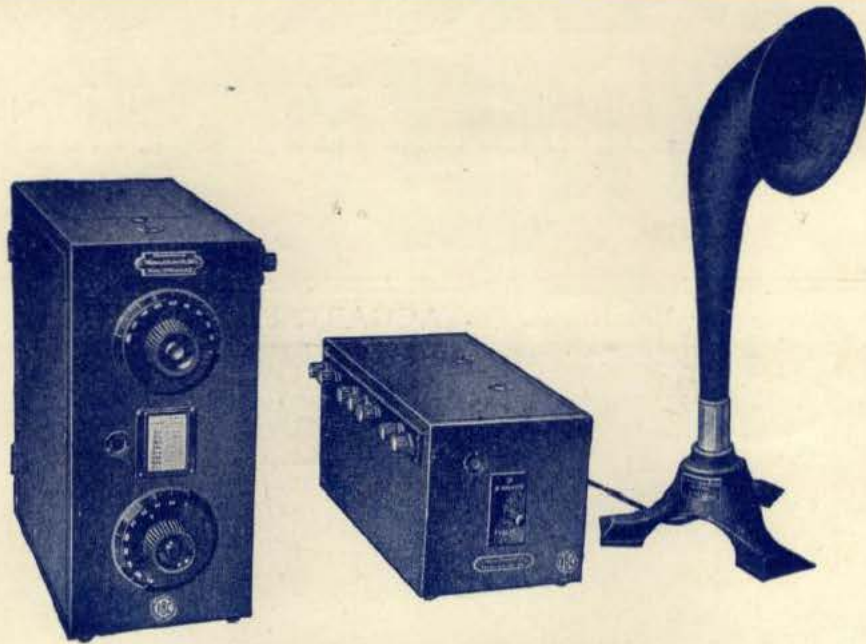

Western Electric
Assembly No. 3.

This Western Electric Loud-Speaking Assembly consisting of:—

Western Electric Valve Detector and Tuner

Western Electric Two-Stage Amplifier

Western Electric Small Pattern (No. 44003) Loud-Speaking Receiver

is most suitable for use in a small room not more than thirty miles from a Broadcasting Station, whilst the introduction of a valve detector obviates the uncertainty sometimes experienced with crystal sets.

The Western Electric Valve Detector and Tuner is contained in a polished mahogany case which provides for the inclusion of double-head receivers. The valve filament can be seen through a specially designed mica window and a ventilation disc is provided to fully ventilate the interior of the case.

The highest grade transformers are fitted in this set.

The Western Electric Low Frequency Amplifier contained in a polished mahogany box is designed and constructed on the most simple lines, and is fitted with a switching key which enables either one or two valves to be used as required without change of connection. The key in its central position disconnects both valves.

The Western Electric Small Pattern (No. 44003) Loud-Speaking Receiver will enable several listeners to enjoy the Broadcast Programme without the inconvenience of wearing head-receivers.

The whole assembly is neat and compact and gives the most satisfactory results.

Western Electric

MAKERS OF OVER HALF THE WORLD'S TELEPHONES.

WHOLESALE ONLY

CONNAUGHT HOUSE, ALDWYCH, LONDON, W.C.

Telephone : Central 7345 (9 lines).

BRANCHES : BIRMINGHAM, LEEDS, CARDIFF, MANCHESTER, NEWCASTLE, GLASGOW, SOUTHAMPTON.

Feeding Back Plate Energy

With the

LISSEN REGENERATIVE-REACTANCE (P. Patent).

The energy induced in the grid circuit by a radio wave is small, and will not reach its maximum strength unless the H.F. resistance and losses in the tuning circuits are neutralised. These small impulses in the grid circuit can, however, induce comparatively powerful impulses in the plate circuit, and it is one of the functions of the **Lissen Regenerative-Reactance** to magnetically couple the plate circuit to the grid circuit, and to feed back again into the grid circuit duly amplified the comparatively powerful plate circuit oscillations. The **Lissen Regenerative-Reactance** increases in amplitude this cycle of operation, neutralises the losses referred to, builds up energy, and induces a condition of negative resistance—or, in other words, the set is oscillating. This non-radiating oscillation can then be controlled at will by adjusting the reaction coupling on the **Lissen Regenerative-Reactance**.

WHERE LISSEN REACTANCE (P. PATENT) SHOULD BE USED.

This **Lissen Reactance** can be used by itself for one or two stages H.F. The best combination is **Lissen Regenerative-Reactance** for the first stage and **Lissen Reactance** for the second stage. Either component can be purchased first and the other added in the appropriate position afterwards when the second H.F. stage is desired.

For best results, tune the **Lissen Reactance** also with a Vernier (preferably the **Lissen Vernier**) where aerial reaction is used—it is entirely self-tuned if aerial reaction is not used.

Range 150-600 metres, **£1 7s. 6d.**

Range 150-10,000 metres, **£1 12s. 6d.**

Blue print sent with all **Lissen Radio Frequency Units**—all **Lissen One-Hole Fixing**—no switch to connect—no complications.

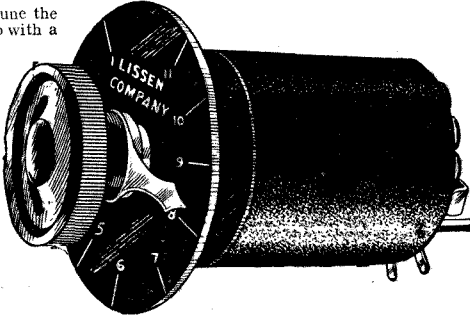

RESONANCE IN TRANSFORMERS IS BAD.

If in the winding of a low-frequency transformer there is any tendency to resonance it is impossible to have perfect reproduction. There are three types of **Lissen L.F. Transformers**, and the design and construction of each makes resonance impossible.

WHERE TO USE LISSEN TYPE T1.

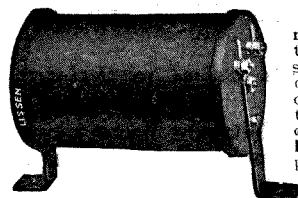

This is the transformer so strongly recommended in the recent tests. It is the only transformer made that is designed to match average valve impedance. No other transformer has a sufficiently high primary impedance to function properly immediately behind the detector valve. The **Lissen Type T1 Distortionless Transformer** is ideal in this position because it has the necessary high impedance value. Its coil alone weighs

about 8 ozs. Every turn of its many thousands is wound by patent process. It has the most expensive coil of any. A beautiful transformer. Use it (particularly) for the first stage, and also for any stage. A wonderful power amplifier. **30s**

WHY THERE IS THE LISSEN TYPE T2.

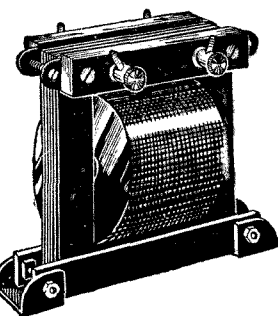

The transformer for the 2nd and 3rd stage L.F. need not have such a high primary impedance. This **Lissen Type T2** has a larger coil than any similar transformer. It gives perfect amplification in a background of absolute silence. Use it for the first or any stage. Recommended in combination with the **Lissen T1**. May also be used for power amplification. **25s**.

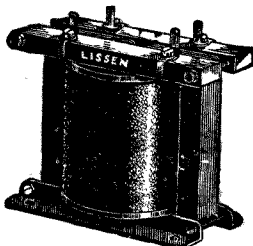

The POPULAR LISSEN TYPE T3. This is the **Lissen Type T3**, described in the recent tests as one of the best light transformers made. Amplifies equal to many other expensive transformers. No trace of distortion. Carries the **Lissen** name guarantee, and is a really excellent transformer. **16s. 6d.**

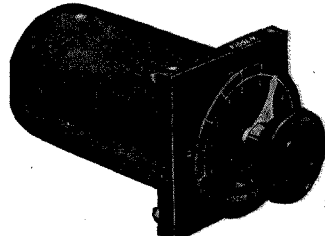

—it is not obtained with a swinging coil. Price **£2 12s. 6d.** **Lissen Regenerative-Reactance** provides an unequalled first stage H.F.

IS YOUR RHEOSTAT A "LAMP-LIGHTER"?—THE LISSENSTAT IS A CONTROL.

Mere lighting of your valve filament is not filament control. Your old wire rheostat will light your valves, but every time it is moved its jerky action, its violent current fluctuations, sets up such noises in your Detector and H.F. valves that it is impossible to get fine tuning. The tuning of the Detector Valve in particular is such a critical thing that good long-distance reception is made extraordinarily difficult and even impossible by the use of the ordinary wire rheostat. See what **Lissenstat Control** does—with this new device filament heat can be so regulated that the filament temperature is made exactly right for the perfect tuning of your Detector and H.F. valves—try the difference on long-distance reception!

Saves its Own Cost. **Lissenstat Control** lengthens the life of valves because it is impossible suddenly to throw a violent fluctuating current on to the delicate valve filament. Replace your existing rheostats with **Lissenstat Control**—see that only **Lissenstats** go into your new receiver.

The Detector valve should have a separate **Lissenstat**—each H.F. valve also. Three stages of L.F. may be controlled by one **Lissenstat** (although even here separate control is better). Length under 2 in., diameter 3/16 in., **Lissen** one-hole fixing.

WHY THE LISSEN TUNER IS WOUND WITH STOUT WIRE.

The old type of single layer, plain wound inductance has to be wound with comparatively fine wire to keep down its bulk. Its ohmic resistance therefore is high.

The unique **Lissen** method of multi-winding makes it possible to use stout wire for the **Lissen Tuner**. The ohmic resistance of the **Lissen Tuner** is therefore very low, its selectivity high, and tuning very sharp. The turns not in use are shorted, and there is such little "dead-end" effect that it will tune to any given wavelength as sharply as a plug-in coil wound for that identical test wavelength. It covers all wavelengths between 150 to 4,000 metres, with a .0005 condenser (preferably use the **Lissen Mica Variable Condenser**, price **17s. 6d.**). This **Lissen Tuner** is unique in its design and efficiency—it is a tuner you would like to use. Price **22s. 6d.**

Can also be used as a very highly efficient anode coil.



SHORTLY TO BE INTRODUCED.

New series of **LISSENAGON (P. PATENT)** air wound, super-efficient, plug-in coils—SEE THE GREAT AIR SPACE BETWEEN WINDINGS!

All good radio dealers will show you these. If any difficulty, take no substitute, send direct to factory.

Dealers should please order a few days ahead. Orders executed and charged for through any factor whose name and address is given. Alternatively ask your factor or order direct if any difficulty.

MAKE SURE YOU ARE GIVEN THE GENUINE LISSEN APPARATUS.

LISSEN COMPANY,
20-24, Woodger Rd., Goldhawk Rd.,
Shepherd's Bush, London, W.12.
Phone: 1072 Hammersmith.

N.B.—Close to Goldhawk Road (Met.) Station, Shepherd's Bush (Central London), or Hammersmith Tube. Buses 11 and 32. LISSEN APPARATUS—WELL THOUGHT OUT, THEN WELL MADE.

"MAGNAVOX"

THE PIONEER LOUD SPEAKER

Unsurpassed for Volume
and for Clarity of Tone.

USE IT OUTDOORS ON
SUMMER EVENINGS FOR
REPRODUCTION OF BROAD-
CAST SPEECH AND MUSIC.

Obtainable from all Electrical Dealers and Stores.

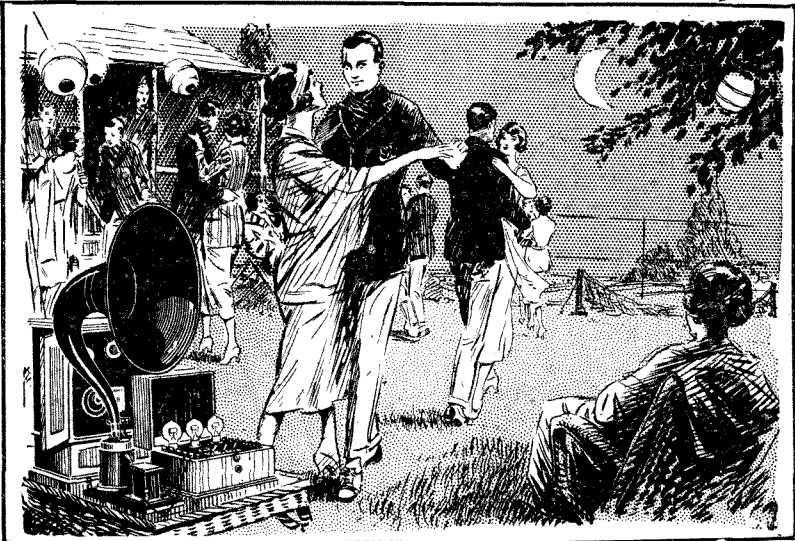

Write for Booklet, "Radio in Summer-time."

STERLING TELEPHONE & ELECTRIC Co. Ltd.,

Manufacturers of Telephones and Radio Apparatus, etc.
(WHOLESALE ONLY)

Telephone House, 210-212, TOTTENHAM COURT ROAD, LONDON, W.1.

Telephone: Museum 4144 (7 lines).

Telegrams: "Cucumis, Wesdo, London."

BIRMINGHAM: 150, Edmund Street.

CARDIFF: 10, Park Place.

MANCHESTER: 14, St. Peter's Square.

NEWCASTLE-ON-TYNE: 9, Clavering Place.

WORKS: Dagenham, Essex.

CHARGE!

your Filament Batteries at Home.

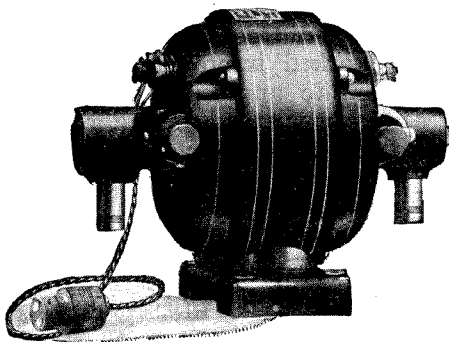

ELLA CONVERTERS

D.C. £5 : 12 : 6, carriage paid. Output
5 amps., 9 volts. Also A.C. (Prices on
receipt of voltage and periodicity of circuit).

Send for list of "ELLA" Wireless Accessories.

TRADE SUPPLIED.

LIONEL ROBINSON & CO.

(Dept. M.W.), 3, Staple Inn, London, W.C.1.

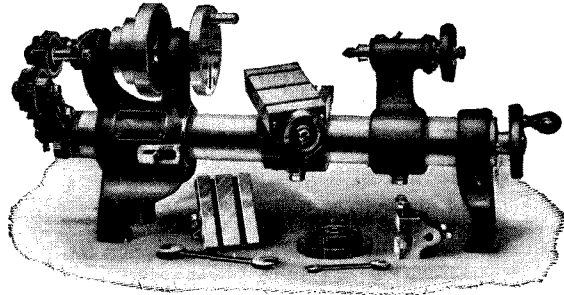

To all Experimenters

the ideal tool for all-round utility,
wide scope and genuine worth is the

DRUMMOND 4-in. Universal Lathe

Besides all turning and screw-cutting, this lathe, with its circular
bed, sliding saddle with slotted face, and the slotted and
swivelling top slide, enables thousands of milling, drilling,
boring and facing jobs to be performed speedily and
accurately. Our lists give full details. Price only **£9**

DRUMMOND BROS. LTD. REID HILL, GUILDFORD

Post this Coupon

Please send me list
of 4-in. lathe, with
details of deferred
payment system.

Name

Address

Send in unsealed
envelope for £d.)

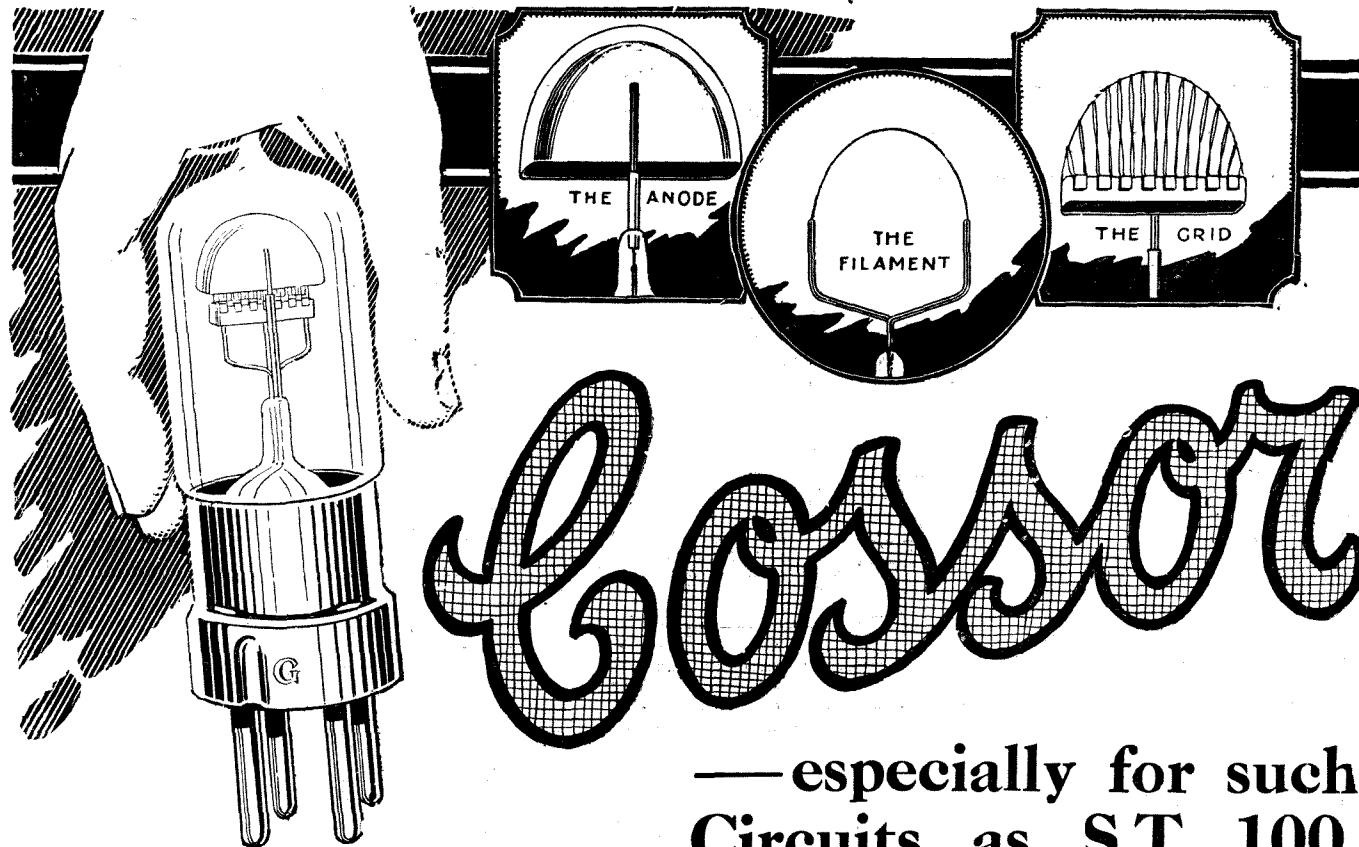

— especially for such
Circuits as S.T. 100.

**Note these exclusive
 COSSOR features :**

- 1.—A hood-shaped Grid and Anode of robust construction ensure long life. The Grid—with its interlaced wires anchored in three places—is a positive guarantee against microphonic noises.
- 2.—The curved filament, securely welded on stout electrodes, cannot sag or fall. This ensures *unvarying* results throughout the whole life of the valve.
- 3.—The Grid and Anode so enclose the filament that practically the whole of the electron stream is used. This ensures perfect rectification, with an exceptional freedom from distortion.

ALL dual amplification Circuits involve a severe test on the efficiency of a Valve, because it is called upon to amplify at high and low frequency simultaneously.

The unique construction of the **Cossor**, with its high efficiency factor, renders it particularly suitable for use in such Circuits.

If you have had disappointing results from your new Reflex Circuit, insert a **Cossor** Valve and note the difference. The marked improvement will surprise you and cause you to appreciate why five experimenters out of every six have standardised on the **Cossor** for all difficult reception work.

Sold by all Dealers and
 manufactured throughout by
 Cossor Valve Co., Ltd.,
 Highbury Grove, N.5.

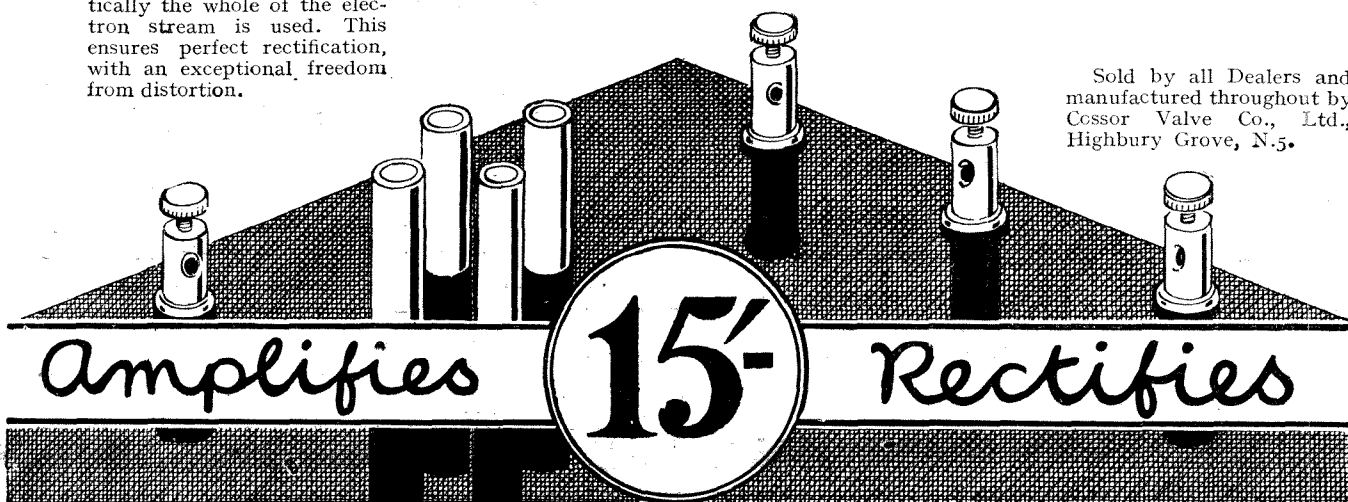

HULLO EVERYBODY!

VARIABLE CONDENSERS ASSEMBLED AS ILLUSTRATED.

DRILLED EBONITE ENDS TO FIX YOURSELF 1/- PER PAIR EXTRA

| Approx. Cap. in Mfd. | No. of Plates | Price |
|----------------------|---------------|-------|
| .001 .. | 57 .. | 6/6 |
| .0005 .. | 29 .. | 4/6 |
| .0003 .. | 19 .. | 3/3 |
| .0002 .. | 13 .. | 2/6 |
| .0001 .. | 7 .. | 2/3 |
| Vernier .. | 3 .. | 1/9 |

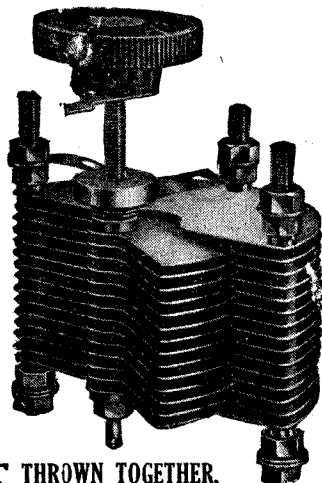

NOT THROWN TOGETHER.

COMPLETELY ASSEMBLED AS SHOWN.

| | |
|-------------|------|
| .001 ... | 8/- |
| .0005 ... | 5/11 |
| .0003 ... | 4/11 |
| .0002 ... | 3/11 |
| .0001 ... | 3/6 |
| Vernier ... | 3/3 |

With Circular Ends, 1/- extra on above prices.

ALL ORDERS BY POST MUST BE ACCOMPANIED BY 9d. PER SET EXTRA—OTHERWISE NOT EXECUTED—AS GOODS ARE SO CHEAP.

To Callers 1d. in the 1/- off Condensers.

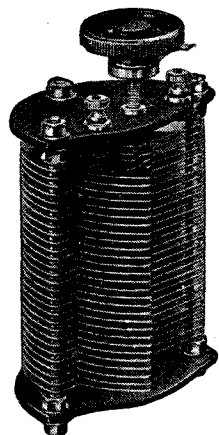

Variometer on ebonite, W. 250/750 metres, internally wound. Very fine. Sell at sight. 17/11.
 Fixed Condensers (from .0002 to .006), 9d., 10d., 1/-, 1/6.
 Ebonite Dials (with knob 0-180), 1/4 and 1/6.
 Turned Ebonite Valve-Holders, 8 nuts, 1/-.
 Filament Resistance, 1/8, 1/10, 2/3.
 Filament Resistance, 7 ohms, 3/6.
 French "R" Valves, highest quality, 9/6.
 Moulded Valve-Holders, with nuts, 9d.
 Perikon Crystal Detectors, glass, 2 crystals, 1/4, 1/6 and 2/8.
 Glass Dust-proof high-class Detector (whisker), 3/-.
 Contact Studs and Nuts, doz. 4½d.
 Valve Pins, doz. 7d.
 2 B.A. Nuts, 3 doz. 7d., 1/10 gross.
 4, 5, 6 B.A. Nuts, 3 doz. 6d., 1/6 gross.
 Terminals, special offer with nut, 4 for 3½d.
 Valve Legs and Nuts, 1d. each, 9d. doz.
 Valve Legs, with shoulder, 2 for 2½d., 1/- doz.
 Switch Arms, very good, 8d., 10d., 1/3.
 Twin Flex, 4 yards 7d., 12 yards 1/7½d.
 Genuine (Shaw's) Hertzite, 9d., 1/-, 1/3.
 100,000 ohm Resistance, 2/3.
 T.M.C. Phones, 4,000 ohms, B.B.C., 22/6.
 Grid Leak and Condenser, .0003, 2/-.
 Coil-Holders, 3-way, on Ebonite, 6/- and 6/6.
 15 v. H.T. Batteries, 2 plugs, 2/3½d.
 30 v. H.T. Batteries, 2 plugs, 4 1½d.
 36 v. H.T. Batteries, 2 plugs, 4 6½d.
 100 ft. 7/22 Aerial Wire, 4 Egg Insulators, the lot 2/6. No post orders.
 Real Ebonite Knobs, 2 B.A. Bush, 3d.
 Marconi "R" Valves, 13/3.
 Brunet 4,000 ohm genuine 1st quality Headphones. 17/11.
 H. and K. 6,000 ohm Headphones, extra loud, 15 11.
 H.T. Batteries, 2 Wander plugs, 66 volt, 8/3.
 H.T. Batteries, 2 Wander plugs, 60 volt, 8/-.
 Aerial Wire, 7/22, per 100 ft., 2/3½ and 2/1½. (No post orders.)
 Rotax Accumulators, 4 v. 40 amp., 15/6.
 Phone Cords, double, extra long, 10d.
 5-1 Inter-valve L.F. Transformers, 11/6.
 Wound Coils, 6 x 3. Turns 180, W.L. 1,100, 1/6.
 Wound Coils, 12 x 4. Turns 400, W.L. 3,800, 2/6.
 Variometers, very good value, 250/750, 3/5.
 Crystal Detectors (whisker), extra value, 1/1 and 1/3.
 Large Telephone Terminals, 2 B.A., with nut and washer, 2 for 3d.
 Terminals, all kinds, with nuts and washers, 4 for 5½d.
 Basket Coils (6 in set) up to 3,000 metres, well made and efficient, 2/2.
 1 Switch Arm, 12 Contact Studs and Nuts, the lot 1/-, by post 1/6.
 Sleeving, takes 18-gauge wire, 3 yards for 1/-.
 Insulating Hooks, 3 for 3½d., 1/- doz.
 D.P.D.T. Switch, compact, high-class article, 2/3½.
 4 yards Copper 18-gauge Connecting Wire, 2d.
 6 yards Bell Wire, 2½d., best quality 6 yds., 3d.

We want your business by post, but MUST have postal charges as follows: Up to 10/- 2d. in the 1/- (or any part); Up to 20/- 1½d. in the 1/- (or any part). Over 20/- carriage paid. (Condensers excluded.)

Please note that a special discount 1d. in the 1/- is given off many articles in the windows where not marked NETT. This must save you a large sum, as in any case profits are reduced to a minimum.

Special Prices Radio Clubs and Trade.

IN STOCK.—Radio Instrument, Ltd., Intervalve Transformers (L.F.), Mullard Ora, Cossor, Ediswan Valves and Crystals of every description (from) 3d.

Everything you want for your set.

ON FRIDAY, SATURDAY AND SUNDAY
 SPECIAL CHEAP PRICES TO CALLERS

TRADE SUPPLIED.

RIGHT OPPOSITE
 DALY'S
 GALLERY DOOR

M. RAYMOND
 27, LISLE STREET, W.C. 2.

Phone: Gerrard 4637
 OPEN 9 to 8
 Saturdays, 9 to 6 p.m.
 Sundays, 11 to 2.



Contents

| | Page |
|--|------|
| Editorial | 479 |
| The "ST 75" | 481 |
| By PERCY W. HARRIS. | |
| The British Broadcasting Company's Position | 486 |
| By P. P. ECKERSLEY, B.Sc. | |
| Undesirable Noises in Valve Receivers and their Prevention | 489 |
| By JOHN SCOTT-TAGGART, F.Inst.P. | |
| In Passing | 493 |
| A Simply Made Crystal Receiver | 495 |
| By D. THEWLIS. | |
| A Power Amplifier | 498 |
| By G. P. KENDALL, B.Sc. | |
| Crystal Points | 503 |
| A New High Frequency Amplifying System | 505 |
| By JOHN SCOTT-TAGGART, F.Inst.P. | |
| A Note on Telephone Receivers | 509 |
| Above and Below the Broadcast Wavelength | 511 |
| The Measurement of Signal Strength. Part II. | 514 |
| By A. D. COWPER, B.Sc. (Lond.), M.Sc. | |
| What Others Think | 519 |
| Summer Radio | 521 |
| "Directional Wireless" | 523 |
| By J. ROBINSON, M.B.E., Ph.D., M.Sc., F.Inst.P. | |
| Adding a High Frequency Stage to the "ST 100" | 527 |
| By A. D. COWPER, B.Sc. (Lond.), M.Sc. | |
| The Measurement of Wireless Quantities. Part II. | 530 |
| By E. H. CHAPMAN, M.A., D.Sc. | |
| Ultra-Sonic Waves for Submarine Signalling | 534 |
| Recent Progress in the Manufacture of Silica Valves | 535 |
| By J. H. T. ROBERTS, D.Sc. | |
| Directional Wireless on Ship or Shore? | 540 |
| By Lt.-Col. H. F. TOWLER. | |
| A Note on Loud Speakers | 542 |
| Glass Enclosed Detectors | 542 |
| A Novel Three Coil Holder | 543 |
| By R. W. HALLOWS, M.A. | |
| "Tested by Ourselves" | 546 |
| Practical Notes | 555 |
| Information Department | 557 |
| Aerials for Short Wave Transmission | 559 |

Editor:
JOHN SCOTT-TAGGART,
F.Inst.P.

Assistant Editor:
E. REDFATH.

Staff Editors:
J. H. T. ROBERTS,
D.Sc., F.Inst.P.
E. H. CHAPMAN,
M.A., D.Sc.
A. D. COWPER, M.Sc.
G. P. KENDALL, B.Sc.
A. L. M. DOUGLAS.
R. W. HALLOWS, M.A.
S. G. RATTEE.
PERCY W. HARRIS.

Scientific Adviser:
Prof. G. W. O. HOWE,
D.Sc., M.I.E.E.

Advisory Editors:
Prof. R. WHIDDINGTON,
M.A., D.Sc.
Prof. C. L. FORTESCUE,
M.A., M.I.E.E.
Tel.—Central 4393.

Advertisement Managers:
SCHEFF PUBLICITY
ORGANISATION, LTD.
125, Pall Mall, London,
S.W. 1.
Tel.—Regent 2440.

MODERN WIRELESS

Radio Press Ltd
PUBLISHERS OF WIRELESS WEEKLY
DEVEREUX COURT.
• STRAND.W.C.2 •

All correspondence relating to contributions is to be addressed to the Editor of "Modern Wireless."

Nothing contained herein is to be regarded as permission or encouragement to infringe any patent rights.

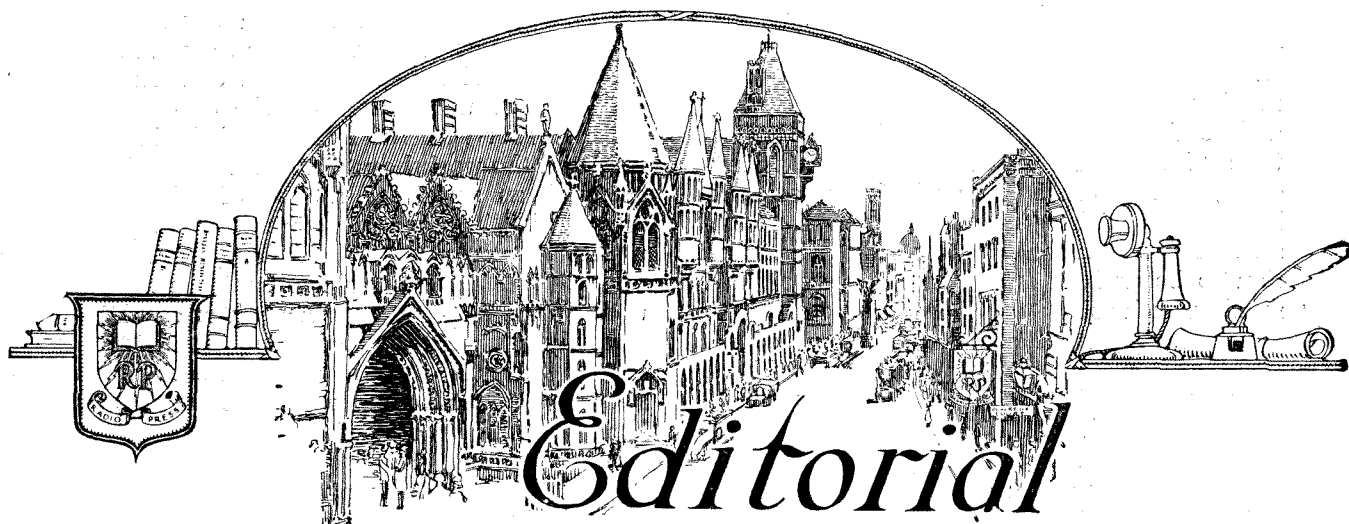

NO wireless magazine has ever given its readers more varied fare in its constructional articles and practical notes than MODERN WIRELESS, yet in our constant endeavour to improve the magazine and cater more fully for the wishes of our readers we sometimes wonder whether our constructional articles are giving the greatest benefit to the greatest number. Every genuine wireless experimenter wishes to make his own apparatus, whether it be the simple crystal set, or the elaborate multi-valve instrument with switches for every possible adjustment. What are your own particular tastes in this direction?

In MODERN WIRELESS, and its companion paper, *Wireless Weekly*, we see to it that the articles actually describe real apparatus and are not merely designs which the writers *think* might work if they were properly made. Yet there are so many ways of making efficient wireless apparatus that it is by no means easy to know exactly what our readers most appreciate.

For sheer simplicity, no method equals that of disposing the various component parts upon a long board, the parts being progressively arranged and wired, so as to resemble as closely as possible the order in which they appear in a theoretical diagram. Practically all new circuits are discovered and worked out in this way, as you will find if you visit the homes and workshops of the pioneer experimenters. The neatly-finished

commercial sets with their gleaming brass-work and highly polished cabinets are vastly different pieces of apparatus from the experimental forms of which they are the commercial developments, but they work no better, and indeed, in some cases worse than their prototypes. Firstly then, do you like articles which describe the general lay-out of experimental apparatus to give the results required? A typical article of this kind was that describing the S.T.100 circuit in No. 5 of this magazine.

* * *

There is another kind of "How-to-Make" article in which the apparatus is finished to a higher degree than in the case of the long board set, the parts being arranged symmetrically and wired up in a fashion, which retains the general simplicity of the experimental apparatus, yet gives some of the benefits of commercial type. Such sets can be constructed with the minimum of expense and do not take up the great amount of space sometimes necessary in the more elementary form.

A typical article of this kind was that by Mr. Percy W. Harris in No. 6 of MODERN WIRELESS describing a simple form of S.T.100 circuit for the beginner. Judging from the application for blue prints we have received, this type of instrument is very popular with our readers. We ask you, then, secondly, is this the kind which appeals to you personally?

Still again, there is a numerous class of

experimenters who think that if a set is worth making at all, it is worth doing well. Such people do not grudge a few shillings on a sheet of ebonite, and a further expenditure on a cabinet suitable for the instrument they are making. They take great pleasure in producing a piece of apparatus which resembles the better type of commercial set. Indeed, in many cases, it may excel those which are sold at high prices. There is certainly much to be said for this point of view, and for the instruction to be derived from genuine instrument-making, such as is now possible with the many excellent component parts available to every experimenter. The production of a cabinet instrument with all the fittings generally associated with a high price commercial receiver, is perhaps a slightly more arduous task, but many consider the additional work is well warranted by the convenience of handling the finished article. A typical set of this kind is that described by Mr. G. P. Kendall, B.Sc., in the current issue. Is this kind of set more pleasing to you? Again we would value your opinion. No radio magazine in the world has better facilities than MODERN WIRELESS for the production of first-class and thoroughly sound "How-to-Make" articles. Its editorial staff numbers, as everyone knows, some of the foremost constructional writers in the country. These are all at your service, ready to design, make, and subsequently describe, just the kind of sets you require. Perhaps you have been looking in vain in wireless periodicals for a particular kind of set you wish to build yourself, but cannot find clearly described anywhere. Write to us, and if it is considered of sufficient general interest the apparatus shall be designed, built, photographed and described, in an early issue.

You may not feel inclined in these warm summer days to embark upon the construction of an elaborate wireless set, but it is just as well to consider in good time what you are going to do in the coming autumn months, when the darker evenings and cooler weather will tempt you to stay indoors and occupy yourself with such work. The coming winter will see a great boom in the home construction of wireless apparatus, and we are naturally anxious to do all in our power to provide the fare required.

* * *

Serious experimenters are already beginning

to consider their programmes for the coming winter. There is much to be done and many fascinating avenues of research open themselves before us. It is a mistake to think that genuine experimental work and construction can only be undertaken by the experienced experimenter with the facilities of the laboratory and the workshop to hand. Any enthusiast with an aerial set, a pair of telephones and the will to work can contribute his quota to the common good. It is the constant cry of scientists that they lack sufficient data upon which to place their new theories. Particularly in regard to atmospheric phenomena, this absence of data is pronounced. Mere statements unsupported by figures are of very little use, for signals which one man might consider strong, to another would appear weak. Much depends upon the observer; the man who has but recently given up a crystal set in favour of the valve will find that he is likely to describe as strong signals which to an experienced valve user will appear weak. The "shunted-telephones" method described recently in this magazine by Mr. A. D. Cowper will remove this element of uncertainty and give the experimenter some kind of true measure of strength, which he can compare with the results obtained by others.

* * *

Those readers of MODERN WIRELESS who do not regularly take *Wireless Weekly* have missed many splendid articles in the past month. The great advantage of a weekly periodical is that it can serve up the wireless news red-hot, and place in the hands of the experimenter new circuits and new ideas which would otherwise wait several weeks for publication.

The new Flewelling circuit, for example, which was published in the *Wireless Weekly* just recently is already giving wonderful results in the hands of many experimenters. With *Wireless Weekly* and MODERN WIRELESS together the reader can safely reckon that he is well informed of all that is going. Although *Wireless Weekly* is the youngest of the weeklies, there is no special secret in its popularity. A true vision of what the wireless public really needs, an active and experienced editorial staff, and a steady stream of first-class articles, attractively produced, all have their effect.

THE ST. 75.

AN INTERESTING DUAL AMPLIFICATION RECEIVER

By PERCY W. HARRIS (Staff Editor.)

In this article Mr. Harris gives constructional details of a receiver in which several novel features are incorporated. As reaction takes place on the anode coil and not directly on the aerial, this instrument can be safely used with reaction amplification on broadcast wavelengths.

THIS month I am able to give you constructional particulars of another very interesting dual amplification receiver, the circuit of which is due to Mr. Scott-Taggart and is known as the ST 75. In addition, I think readers of MODERN WIRELESS will be interested in a new design, or rather designing method, in which the set forms its own wiring diagram. For some time I have wished to make sets which, while being efficient electrically, should be very simple, constructed

with well spaced wiring arranged so that any curious person could follow out all the connections without needing to take off a panel or to turn the whole instrument upside down. For clubs and schools the new method is ideal, as not only is everything fully visible, but very few holes are needed in the base board, and as a consequence the circuit can be frequently changed without much expense for the replacement of parts.

The ST 75 circuit consists of two valves, the second valve acting as

the rectifier. In this it differs from the ST 100 and many other dual amplification circuits, which use a crystal for rectification. While not so sensitive as the ST 100, it is still sufficiently sensitive to work a loud-speaker quite comfortably up to 20 or 30 miles from the broadcasting station, and the purity of speech and music is very good. Many readers will appreciate the absence of the crystal, which in unskilled hands occasionally gives trouble in adjustment. The ST 75 can be switched on and off at will, and the

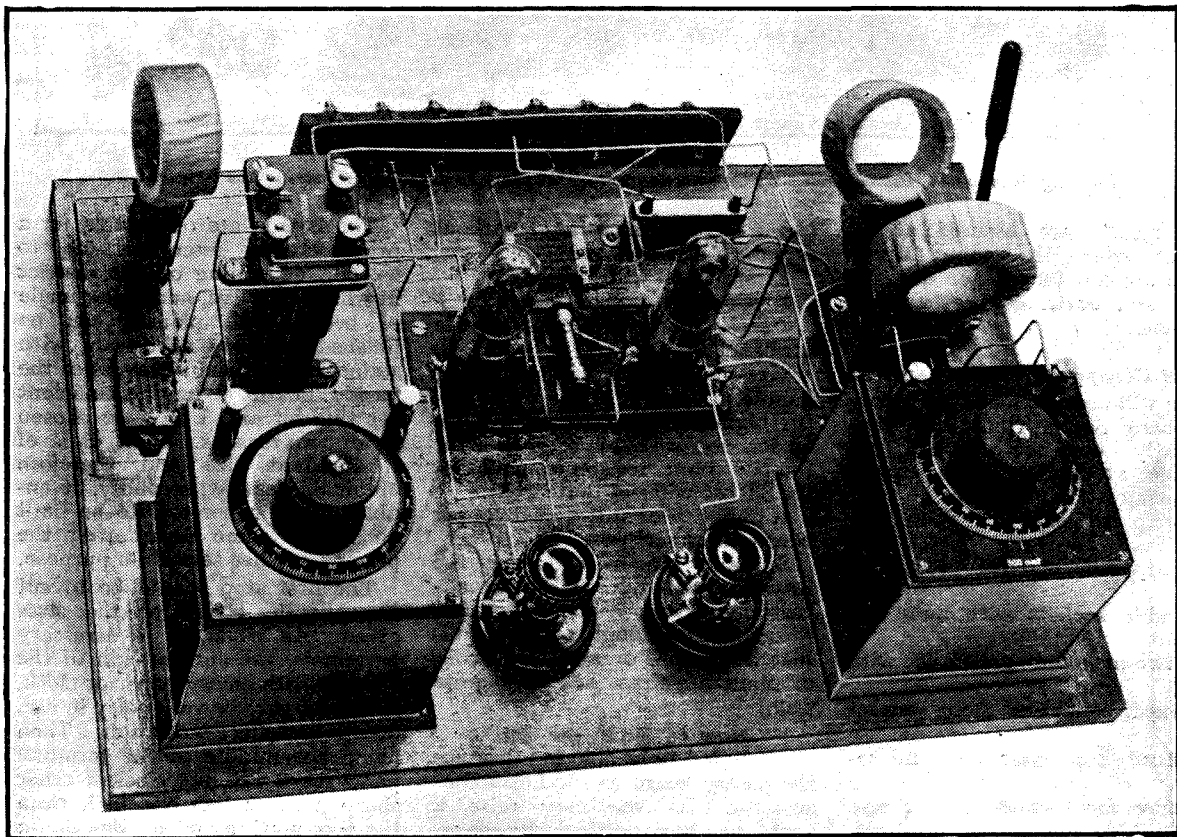

A front view of the receiver, showing the "above-board" wiring method and disposition of the components.

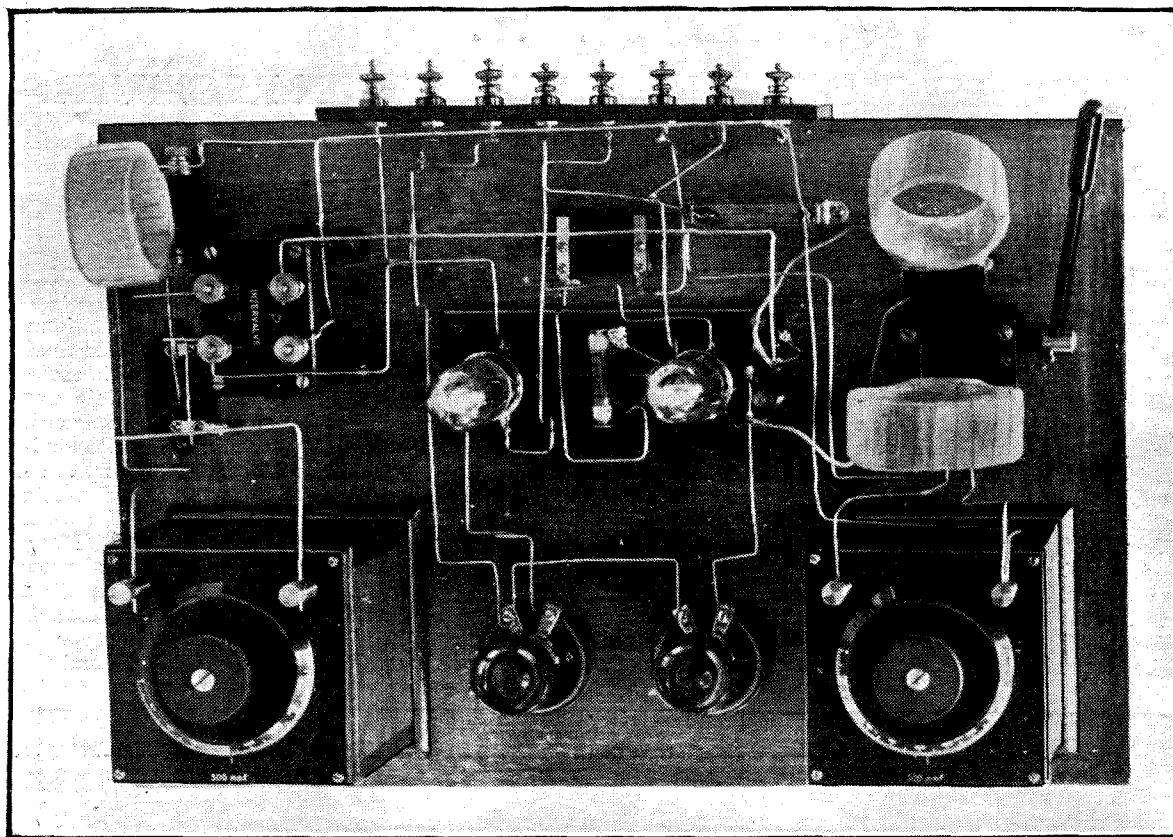

Looking down on the instrument. By an examination of the three photographs all wiring can be traced.

same results are assured at all times, provided the tuning adjustments are left in position and the aerial and earth connections are the same.

List of Component Parts required

- You will need, to make the set:—
- A base board (this can conveniently be a pastry board, obtainable at any domestic stores) measuring 12 in. by 18 in.
- 1 strip of ebonite, 8½ in. by 2½ in.
- 1 strip of ebonite, 6 in. by 2½ in.
- 8 valve sockets with nuts and washers.
- 1 two-megohm grid-leak with clips.
- 1 fixed condenser .0003 microfarad.
- 1 fixed condenser .001 microfarad.
- 1 large fixed condenser of any size from .01 microfarad upwards.
- 2 filament resistances of suitable type.
- 2 variable condensers each of .0005 microfarad (one of these

can be .0003 microfarad without any disadvantage).

- 8 terminals with nuts.
- 1 intervalve transformer.
- 1 socket for plug-in coils suitable for panel mounting.
- 1 two-coil holder with adjusting handle.
- 1 high-resistance leak of a value of 80,000 or 100,000 ohms (the 100,000 ohm resistance sold for the ST 100 will suit quite well).
- A quantity of stiff tinned copper wire for connections.

Suitable plug-in coils for the wavelengths required. (For broadcasting a 25, 35, 50 and 75 Igranite, a set of Burndept concert coils plus a 75 coil, or any other coils of similar values will suit quite well.)

How to Build the Set

I am glad to be able to introduce the pastry board to the home constructor. Its use may raise a smile, yet it is particularly adaptable to the present purpose, as it is made of a good hard wood and the ends are finished off quite neatly.

The boards are obtainable for a price varying from 1s. 6d. to 2s. 6d., depending on the district in which you live, and being made of beech, well planed, can be finished off very effectively with stain and varnish. The size of the pastry board is amply sufficient for this set, and I have so chosen it for two reasons. First, it is of a standard size and therefore obtainable easily; secondly, it enables many other sets to be built on to the same board after the present set has served its purpose.

The first step should be to cut the ebonite strips to the sizes given. As usual, it is necessary to remove the surface skin of the ebonite with emery paper or cloth, or the set may be very noisy in use, due to imperfect insulation. Then along the middle of the terminal panel mark with a scribe or other sharp point a line one inch from the top, marking off on this line a point ¼ in. from one end and seven subsequent points an inch apart. You will find that the last of these points is ¾ in. from the opposite

end. Now with a centre punch, French nail, or other similar device, and a hammer, make a slight depression on each of these markings to receive the point of the drill. If you do this you will make sure that the drill point will not wander when you start to bore the hole. The holes can now be bored and the terminals fitted in place. Three additional holes are required to hold this strip against the edge of the base board. These holes should be drilled at a distance of $\frac{3}{8}$ in. from the bottom (or, if the base board is more than $\frac{3}{8}$ in. thick, the holes can be bored so as to come in the middle of this base board when the panel is screwed in place with its bottom edge flat with the underside of the base board.) The three holes should be made one at each end of the panel ($\frac{3}{8}$ in. from the end is sufficient) and one in the centre. If you have a counter-sink bit handy to fit into your drill or brace you can counter-sink these holes to take ordinary brass wood screws. If you do not possess a counter-sink bit, make a plain hole and use round-headed wood screws to hold the panel in place. The next step should be to prepare and drill the ebonite panel which takes the valve

sockets and the grid-leak. The two sets of valve sockets should be placed as shown in the photograph, and in drilling these holes you will find the MODERN WIRELESS template useful. The two clips are fitted to the middle of the panel to take the grid-leak, which has a value of two megohms. The spacing of these clips will depend of course on the clips themselves, and on the size of the grid-leak. Some grid-leaks are made to mount direct on to a panel without clips. In addition to the holes for the grid and valve sockets four corner holes will be required to hold the panel to the base board and you should also drill two additional holes on the extreme right to take two 4 B.A. metal screws which are used in the manner to be described later.

The valve pins screws which hold the grid-leak clips and the two metal screws on the right of the panel will all of course project beneath the ebonite. Before proceeding any further put all screws in place and then mark on the base-board beneath the points where the tails of the screws come. In the case of the valve pins this is easily done by pressing the panel against the base board, when small depressions will be made at the

points immediately below the pins. A little measurement will show where the other screws come. As soon as the necessary marks have been made take a brace with a fairly large bit (the largest you can find suitable for the purpose) and drill right through the base board in such a way that there will be plenty of clearance round every projecting screw. A $\frac{3}{4}$ in. augur bit is excellent. This will prevent any of the metal work coming into contact with the wooden base board, which of course is not such a good insulator as the ebonite itself.

As all the wiring is to be "above board," it is necessary that the wire shall be attached to the various points *above* this ebonite panel. To achieve this you have a choice of two methods; you can, if you wish, as I have done, use small soldering lugs underneath each of the valve sockets, grid-leads, clips and metal screws on the panel, or you may use a method which occurs to me as simpler for the uninitiated, by which the valve sockets have a washer and one of the locking nuts *above* the panel, and an additional washer with another locking nut below. The wires can then be screwed between

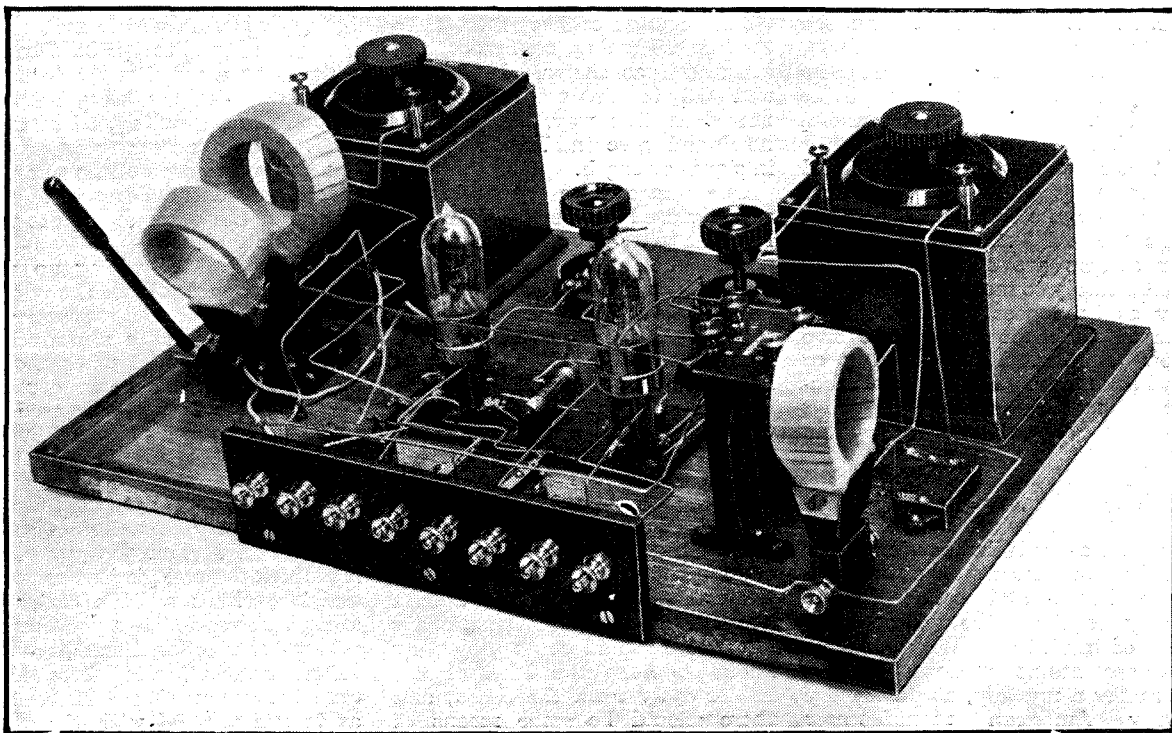

The rear of the instrument showing aerial coil on right, two coil-holders on left and terminal board.

the washer and the under portion of the valve socket without the necessity of intricate soldering work. A similar procedure can be adopted in the case of the grid-leak clips and the screws on the right.

There are two components in this set to which I would like to make particular reference. First of all, we have a new socket for the plug-in coil. In my last article I referred to the fact that, as far as I knew, no manufacturer was marketing a good socket which could be used for panel mounting. On publication of the article I received a courteous letter from Messrs. Watson, Jones and Co., who enclosed for my inspection a socket which they have designed and are marketing for panel mounting. I have therefore used it on this set and find it quite good for the purpose. It consists of an ebonite block carrying the pin and socket for the plug-in coil, connection with which is made by terminals with milled heads projecting from the sides of the ebonite. From the underside of the socket projects a threaded screw, which can be passed through a hole in the panel and secured on the other side by a suitable nut; this holds the socket firmly in place on the panel. If desired, it can be mounted, as in this case, on wood, without any loss of insulation, as no electrical contact is made with the wood. This fitment is quite useful and should have a ready sale.

The other components to which I particularly wish to refer this month are the filament resistances. The "board" method of making up sets is proving very popular and is likely to increase in popularity as time goes on, particularly among experimenters who evolve new circuits. Now several, or rather many, British manufacturers market excellent filament resistances for panel mounting, and several of them are all that could be desired. I find, however, that with very few, and rather expensive, exceptions no manufacturer markets a good filament resistance which can be screwed down to a base board and connected up easily to the valve without any loss of insulation. Why such resistances are not made in England is rather a mystery, as practically every American manufacturer makes them a standard part of his equipment. The two filament

resistances used on this set are of American manufacture, and although I dislike using foreign parts for the construction of these sets, I have been unable to find any British equivalent. These resistances are so made that they can be mounted either on the base board as shown, or on the back of an ebonite panel to be controlled from the front. It will thus be seen that, in addition to having all of the advantages of the standard British type, they can also be used for board mounted sets such as this. If any British manufacturer is marketing such devices, I shall be glad if he would inform me, so that in future I may use them on any sets I may design.

The fixed condenser across the high-tension battery is of .01 microfarad and is of the Dubilier metal case type No. 577. A Mansbridge condenser of, say, .3 microfarad can be used across these terminals just as well. The fixed condenser across the secondary of the intervalve transformer is .001 microfarad, and the grid-condenser which lies immediately behind the grid-leak is .0003 microfarad. It should be particularly noticed that the OP terminal is connected to the two-coil holder flexible leads, and the OS terminal is connected direct to the aerial tuning condenser and aerial coil as shown. If the OP and OS terminals are not connected in this way the set may howl and give indifferent results in signal strength.

The intervalve transformer actually used in this set is the new Ferranti pattern, which I find quite good. The fixed condensers, grid-leak and variable condensers are all of standard pattern. The two-coil holder, which screws to the base board and carries an extension handle, was obtained from Messrs. Leslie McMichael, Ltd. I mention this fact as not all two-coil holders are suitable for use in the position shown. Many of them, whilst excellent for mounting on the side of an instrument, cannot be mounted on a base board, as is done in this case. In order that a two-coil may be fixed to a base board in this manner it is necessary that there should be no projecting knobs to keep the back of the holder away from the board, and there should be some means of adjusting the stiffness of the movement so that the weight of the

coils will not cause the movable coil to fall down by its own weight. The particular two-coil used meets these requirements, and the projecting handle enables adjustment to be made with ease and delicacy.

The general disposition of the parts will be clearly seen from the photograph reproduced with this article. The general arrangements should be carefully followed, or the results may not be satisfactory. If the reader is unable to obtain suitable filament resistances for mounting in the manner shown, it is quite a simple matter to utilise the ordinary type of panel mounting resistance by mounting two of these on a strip of thin wood, which can be held away from the main base board by two thicker strips at each end. Of course, the efficiency will be just as high, but such an arrangement rather spoils the idea of making all the wiring perfectly visible from start to finish. The only holes that need to be cut in the base board are those beneath the valve socket, grid-leak clips, etc., and one hole for the projecting pin of the socket for the coil holder. The fixed condensers can be secured to the base board either with glue or, if they are not fitted into wooden boxes, by any other suitable means. It is, of course, a simple matter to screw the boxes to the base board by passing a wood screw through the wood from the back, but the glue method is quite good enough, as it is only necessary to secure the boxes in place and no strain is placed upon them. Seccotine, Cröid or one of the other cold glues will suit quite well.

The method of wiring up will be quite apparent from the photographs, and it is not necessary in the circumstances to reproduce a wiring diagram. All wires should be well spaced, and the appearance of the set will be enhanced if right-angled turns are made in the wire. For the set in question I have used square section wire, which is very neat; but as this wire is not very readily obtainable, round section wire, provided it is thick enough, is just as good, and is perhaps a little easier to use. Where possible a good sound soldered connection should be made. Where one wire has to join another, one of the wires should be bent so as to run parallel with the other wire for about $\frac{1}{4}$ in. When this is done, and the two wires are held

together, it is a simple matter to run a little solder between them and make a secure joint. As usual, the ends of all screws which have to be soldered should be rubbed bright with a smooth file and tinned before soldering the wires in place. It will perhaps be found a little difficult to use the small soldering lugs underneath the valve sockets, as the space is rather limited; but if the lugs are well tinned first of all and made to carry a small drop of solder, the connecting wires can be joined by pressure with a good hot soldering iron without softening the ebonite beneath. For those readers who wish to make a particularly good job of the set it is recommended that temporary wiring be fitted so as to gauge the size of the connecting wire, and then new connecting wires fitted symmetrically afterwards.

Owing to the fact that the leads of the moving socket of the two-coil holder are constantly moving, it is not possible to use stiff wire for these connections. For this reason flexible leads (two separate lengths of single electric lighting flex) have been taken from the terminal screws of the moving socket to two stiff wires which are made to terminate at the screws on the right side of the valve panel. The flexible leads can easily be soldered to the points as shown, thus keeping the wiring quite neat and efficient. When first made up no resistance was used for stabilising and quite good results were obtained, but the set was found to be far more stable if a resistance was connected between the grid and the filament in the manner shown in the article on the ST 100 set. The 80,000 ohm resistance which I have used in this set is not shown in the photograph, but can be connected between the left-hand terminal of the aerial tuning condenser and the cross wire which joins the two inner valve sockets on the valve socket panel. Readers

may possibly find that in some cases the leak can be omitted without disadvantage.

I do not intend to deal here with the interesting theoretical aspect of the ST 75, as Mr. Scott-Taggart himself has recently dealt with it in *Wireless Weekly*, but it should be pointed out that one of its interesting peculiarities is the fact that the loud-speaker is placed immediately after the plate of the first valve and not in the usual part of the circuit. For this reason it is not practicable to use high-resistance telephones connected to the terminals which are used for the loud-speaker, but it is quite simple to use a telephone

Starting from the left (condensers in front) and looking down on the set, the terminals are as follows:—(1) Aerial, earth, low tension negative, low-tension positive, loud-speaker. (2) high-tension negative, high-tension positive. The high-tension negative is connected to the low-tension positive in this set, as in all other MODERN WIRELESS sets.

Those readers who do not wish to use this "above-board" method of wiring will find it quite a simple matter to modify the set so as to use the method of wiring illustrated in my article on the ST 100 in last month's MODERN WIRELESS. When doing this the terminal board at the back can be arranged

so as to screw flat on the base board (there is plenty of room), and, of course, it will be necessary to drill holes beneath each of the terminal screws. The holes which are drilled for the screws of the valve sockets will also serve for under-board wiring, and other modifications are obvious. With under-board wiring the set will, of course, look a little neater, and where the reader is desirous of using the set for his own interests only and does not desire to show it frequently to

other people, it is perhaps the better method. However, I have taken the opportunity of describing above-board wiring in detail so that any reader of this magazine who cares to apply the method to any other set he may build will find all the necessary details available.

Operation of the Set

One advantage of the ST 75 is that although reaction is used to the fullest advantage, it is on to the tuned anode coil and not directly on to the aerial. The set seems to work quite well with any of the well-known makes of valves, and I have found it advantageous to use about 100 volts on the plates of the valves, although the set will work quite well with 60 or 70 volts,

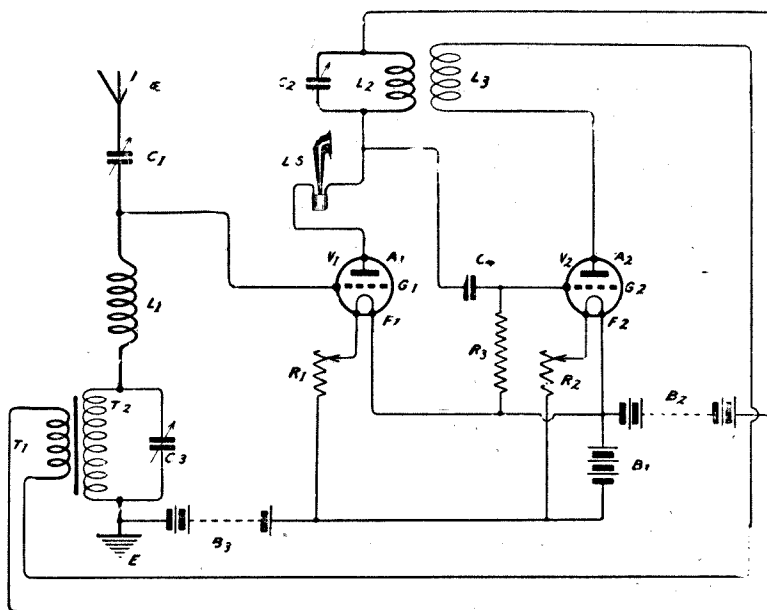

The ST 75 circuit as published by Mr. J. Scott-Taggart, F.Inst.P., in "Wireless Weekly." In the present set the condenser C3 is made fixed, and a 100,000 ohm resistance is added.

transformer and low-resistance telephones in this manner. If it is desired to obtain greater strength, it is only necessary to attach any ordinary note magnifier to the loud-speaker terminals. The loud-speaker can then be run off the output terminals of the note magnifier. It is important that no shunting condenser be placed across these terminals, either when using the loud-speaker direct from the set or when using an additional note magnifier. In dual amplification sets one cannot follow the usual rules, and it is important to follow exactly the instructions given.

When connecting up batteries, etc., the following arrangement of the terminals should be noted.

THE BRITISH BROADCASTING CO.'S POSITION

By P. P. ECKERSLEY, B.Sc.

Chief Engineer of the British Broadcasting Company

THE editor has asked me to make a short statement as to the position, policy, and possible future of the B.B.C. First, it is interesting to review the situation as it stands to-day.

The crux of the matter appears to be that the views of two main sections of the wireless community are not coincident; the experimenter on the one hand wishes to experiment, the ordinary buyer of a B.B.C. set wishes to enjoy the wireless concert as a concert, not as a scientific feat.

But again there are two types of experimenter, the genuine and old-established, and the pseudo experimenter who uses his self-given title as a means to an end.

Let us first consider the position of the genuine experimenter, or "amateur," as he is sometimes called.

At first it might appear that he has been badly treated. He, and he alone, brought about broadcasting. With petitions and propaganda he bombarded the authorities until the Writtle transmissions were started (10 minutes telephony a week was the original grant). The Writtle transmissions heralded the B.B.C., and suddenly the amateur finds that the genii he has summoned up have become unruly, and may, he thinks, turn unkind at any moment.

On behalf of the B.B.C. let me say once and for all that this company is kindly disposed

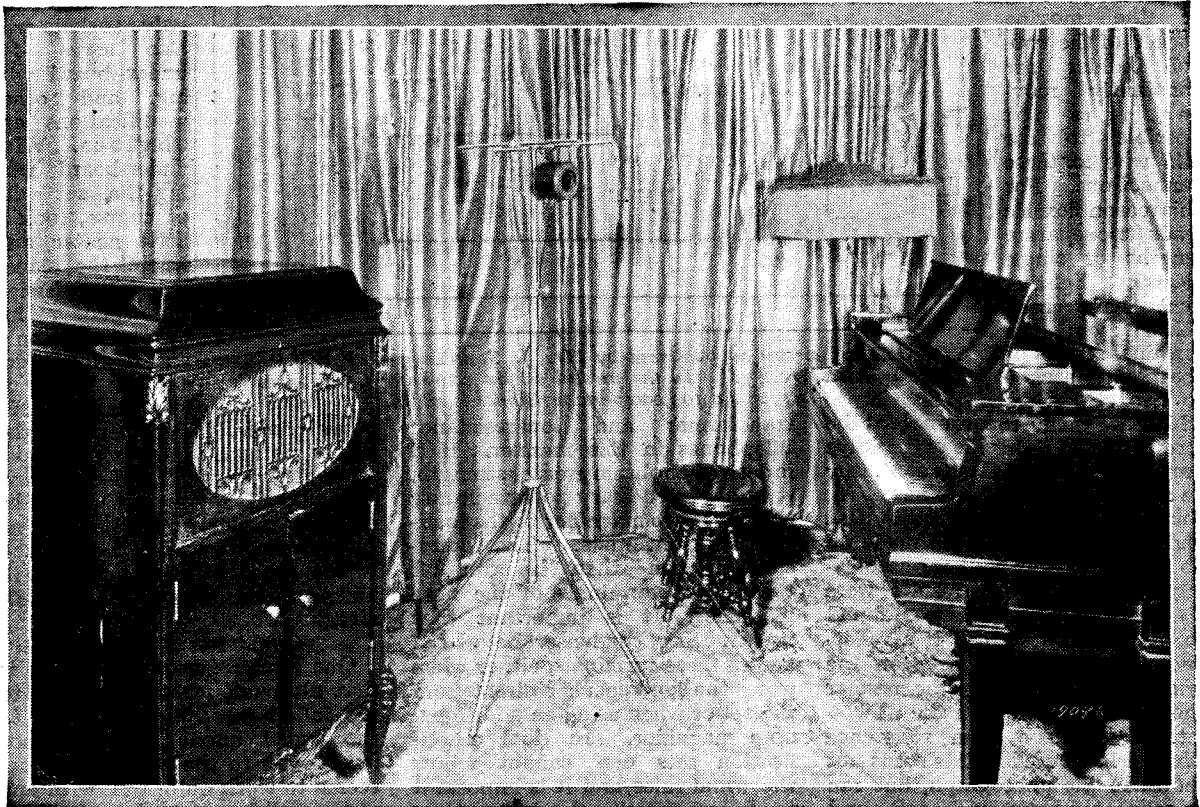

THE STUDIO OF THE ASTORIA BROADCASTING STATION, NEW YORK.
The microphone is suspended from a stand in the middle of the picture. On the left is the cabinet containing the speech amplifier.

towards the amateur, and more, the amateur now has facilities for experimenting greatly in excess of those he had formerly.

I would put forward to your readers the suggestion that if they will concentrate on the question of the reproduction of really good quality of speech in their receivers rather than concentrating on ultra-sensitivity they will be going a long way towards appreciating broadcasting in its proper aspect.

Turning now to the pseudo experimenter, to the man, in fact, who sees no way of listening-in except by making his own set, we arrive at a very difficult situation. He probably tries to get a licence, fails, and does without.

I sympathise with him; he would like to "listen-in." A simple way presents itself to him, and he avails himself of the opportunity.

I would put it to all your readers who "don't see why they shouldn't," and who "couldn't afford a B.B.C. set," that they may see the fallacy of their arguments if they apply a simile.

Jones likes motoring very much. Is this to say that because he has a most excellent opportunity of taking out someone else's car for a run he should do so? The owner is away and "no one would know," and "he can't afford a car of his own," and "he doesn't see why he shouldn't."

Surely the fallacy is obvious, and for the time being "listening-in" must be looked upon as a hobby which, like motoring, or photography, or the cult of the super-gramophone, must be paid for.

Lastly, it is unfortunate that the dishonest are also ignorant, and have the power to upset our concerts by the illicit use of reaction. I appeal to their sense of fairness, and would ask them to realise that not only are they stealing property not theirs, they are also for their own selfish ends destroying other people's pleasure.

The Post Office is, however, trying to arrange matters to make it possible for all to listen-in while giving us fair revenue.

The Revenue of the Company

There has been a good deal of misapprehension regarding the financial position of the British Broadcasting Company. It is assumed because certain large firms are associated with the company that it has endless wealth behind it, and that it can well afford to allow all and sundry to do what they like in the wireless world.

The British Broadcasting Company is not yet in a satisfactory position financially; it has a capital of £100,000 divided into £1 shares, and membership of the company is open to every bona-fide British manufacturer of wireless apparatus. Already hundreds of firms have applied for membership. It is estimated that the cost of equipment, installation and operation of each station will be £20,000 per annum. Six stations are in operation, two more are contemplated.

We have, as you know, two sources of revenue. We get half of the fee from each licence issued by the Post Office; secondly, we receive approximately 10 per cent. of the wholesale selling prices of the sets which bear the B.B.C. stamp.

We have been in existence long enough to know that our anticipations regarding revenue are a long way from being realised. There are a great many sets in existence for which the owners have not even a licence, and consequently those people are listening-in to our programmes without payment of any kind. Further, we know from the manufacturers of wireless apparatus in the country that a vast number of sets have been sold which are not of the approved type, and consequently which do not pay any revenue to the British Broadcasting Company except 5s. a year, half of the licence fee (if there is a licence). It is a matter of conjecture, of course, as to the exact number of illegal sets there are in existence, but in one district we have been informed on reliable authority that there are five illegal sets for every set bearing the B.B.C. stamp. I should not go so far as to maintain that this percentage is general throughout Great Britain, but I am on safe ground in making the statement that the number of non-B.B.C. sets in existence, for the construction of which no experimental licence was obtained, is far in excess of the number of genuine listeners-in.

I do not, of course, wish to raise a cry of panic. The British Broadcasting Company is bound to continue discharging its function, but the financial position is such that it will not be possible for us to give concerts of the standard which we desire for the success of broadcasting, unless matters considerably improve.

Programmes

As regards actual programmes, we can maintain, I think truly, that we have given you excellence and variety. If our financial

position improves, and we can obtain a revenue in proportion to the numbers of those who are enjoying our shows, then, and then only, will we be able to improve the quality of our programmes; we are naturally not inclined to be satisfied; we want to get better and better.

Technical Problems

One of our chief aims and objects is to make reproduction perfect. We are slowly improving our quality, but I would point out to many that nothing destroys our prestige more than the actions of certain people who give demonstrations with crude apparatus crudely handled. Anyone with the slightest sense can receive something from a broadcasting station; it requires considerable skill to get the quality really good. Thus, although again we may radiate perfect quality transmissions, these may be ruined by ignorance on the part of the pseudo experimenter, who knows nothing of the subject really.

We are tackling the problems of interference in a very serious spirit, and though it may be some time before we cure it entirely, we still

shall try our utmost to mitigate the nuisance that is spoiling so many of our transmissions.

Possible Future

If we have full public support there is no end to the possibilities of broadcasting.

We have not started on half the schemes we have in mind, it being difficult enough to keep things running at the moment.

By broadcasting grand opera from the actual theatre in which the performances were taking place we have shown that in Great Britain we are at least as far advanced on the technical side of broadcasting as they are in America. The possibilities of broadcasting are limitless. We hope to have permanent cables laid down to all sorts of places. There is a public demand for the broadcasting of certain public functions. There are many great events pending of world-wide interest and we should like to broadcast them, but it must always be understood that we cannot ourselves make the final decision in these matters. For example, we made strenuous efforts to broadcast the King's Speech, but for some reason unknown to us permission was refused.

BROADCASTING SHAKESPEARE.



An excellent performance of "The Merchant of Venice" was recently broadcast from 2LO. The cast for the occasion is shown above. Standing (left to right): Captain Cecil A. Lewis (Prologue), Mr. R. F. Palmer (Solanio). Seated (left to right): Miss Phyllis Thomas (Jessica), Mr. Gerald Lawrence (Shylock), Mr. Leslie Winter (Nerissa), Miss Cathleen Nesbitt (Portia).

UNDESIRABLE NOISES IN VALVE RECEIVERS AND THEIR PREVENTION

By JOHN SCOTT-TAGGART, F.Inst.P.

This month's article on valves should prove helpful to those who experience unpleasant howls and other noises in their receivers.

A SET which cannot be made to howl or produce other undesirable noises is either well designed or badly designed; anyone can get rid of 99 per cent. of the howls, clicks and buzzes which are sometimes experienced on a valve set by rendering it insensitive. It is nearly always possible to obtain a background of silence by reducing the sensitiveness of the apparatus, by reducing, for example, the high-tension voltage or filament current. This is, however, a very weak effort towards solving the problem of noisy receiving circuits. To decrease the filament current or high-tension voltage may be a wise step in some cases, but more often it has the effect of decreasing the noise by decreasing both noise and signal equally, and thus—since the signal is usually much the stronger—eliminating the noise.

Classification of Noises

Noises in valve receiving circuits fall into remarkably diverse categories. We have growls, ticks, hisses, steady grumbings, crackling noises at irregular intervals, fizzling effects, crashes, the beautifully regular whistlings, hoots and yelps; the yelps are the worst.

Nevertheless, however noisy a set may be, however persistent the undesirable musical efforts, it must be remembered that valves only howl when something unpleasant is happening, and it is lucky for us that when they howl they do so at a frequency which may be heard. If the "noises" made by valves occurred above the audible limit, they would be much harder to diagnose. You must not imagine, however, that all noises, if they may be so called, are audible, or that, if they are inaudible, they are innocuous. A silent "noise" is the worst to deal with; it distorts speech, makes spark signals hoarse and irregular, and other unpleasant effects result.

We will, however, confine ourselves in this article to a consideration of audible noises and their prevention.

I propose to place the causes of noises into four sections:—

1. Those due to faults in the actual receiving apparatus.

2. Noises caused by microphonic effects.

3. Those due to low-frequency oscillation.

4. Buzzing noises due to intermittent high-frequency oscillation.

The noises in the first category are probably the most common; you will know what I mean when I say that it is the kind of noise which at demonstrations is attributed to atmospherics. These noises are of a crackling variety and are usually no fault of the circuit, but of the batteries. High-tension batteries are prone to troubles which cause intermittent clicks and crackles in the telephone receivers or loud-speaker. The high-tension battery consists of dozens of little cells, each of which has to be in good health if the high-tension battery is to be silent. It is only necessary for one of these little cells to become run-down, polarised or affected in any other way for the whole battery to suffer. There will be slight fluctuations in the E.M.F. of the cell, and, therefore, in the E.M.F. of the whole battery, and these slight fluctuations will be amplified by the valves, particularly if there are stages of low-frequency amplification. The slightest fluctuation of the current in the anode circuit of the first low-frequency amplifying valve or the detector valve will result in loud crackles at the end.

There seems to be only one simple method of testing if the fault is in the high-tension battery, and that is to try another battery. This most effective substitution method of discovering a fault practically means a duplication of the apparatus in one's possession, and there is no really effective alternative speedy method. One can test out each section of the high-tension battery with a voltmeter, and if there is a faulty section short-circuit it, but this is not infallible. I would suggest that the best thing to do is to try just one section of the high-tension battery, and note if crackling is obtained with each section. If the set is quite silent up to, say, 45 volts, and then becomes noisy on 60 volts, it seems a fairly clear indication that the high-tension battery is faulty between 45 and 60 volts, and it may be necessary to short-circuit this portion. Before doing anything drastic, however, a cure in the form

of a large capacity condenser may be tried. This condenser may be a $1\mu\text{F}$. Mansbridge fixed condenser. This type of condenser is economical to buy and is frequently sold in $0.5\mu\text{F}$ sizes, two of them being therefore connected in parallel. This large condenser is connected across the terminals of the high-tension battery. The condenser can never do any harm, and it will often do a great deal of good. Not only will it tend to stop the noises due to a slightly faulty high-tension battery, but it will also help to lessen some of the other noises, which we will consider later on. The effect of the large condenser is to steady the voltage of the high-tension battery. The condenser is, in fact, a reservoir condenser, and may be compared to a water reservoir from which a town supply is taken; any fluctuations in the rainfall will not affect the steady flow of water from the reservoir to the town. In the same way, the condenser, as it were, absorbs all the little fluctuations of the E.M.F. in the high-tension battery.

The high-tension battery, however, may be quite innocent, although I must admit that high-tension batteries as a class are always to be looked upon with suspicion.

The next place to look for trouble is the accumulator; this should be fully charged and of good make; accumulators are usually the most innocent elements in a wireless receiver. They are heavy and solid, and suspicion rarely attaches to them. I have, however, known cases where irregular discharging of an accumulator has given rise to noises, and this has frequently been due to a collection of gas on the plates. A larger accumulator is less likely to give trouble than a smaller one, but it is just as well to be on the look out for trouble in this direction. In both the cases of an accumulator and of the high-tension battery noisiness often becomes worse after the set has been in operation for some time.

If the set is silent to commence with and gets noisier as time goes on, this is almost a certain sign that either the high-tension battery or accumulator is at fault. In the latter case, very little can be done to remedy the fault.

If an accumulator discharges irregularly, buy a new one. Temporary relief may sometimes be obtained by shaking the accumulator.

After the high-tension battery, the next component with a bad reputation is a variable grid leak. Ordinary grid leaks of uncertain make are bad enough, but variable grid leaks are ten times worse. I have met with good-quality variable grid leaks, but most of them are too variable. To test whether it is the grid leak which is causing the trouble, replace it by one of known reliability, or, if it is possible to do so without damage, short-circuit the grid leak altogether. If the crackling noise stops, the trouble obviously does not lie in the high-tension battery or filament accumulator; it is practically certain that the grid leak is at fault. Grid leaks using pencil lines on ebonite are the worse offenders. I would never advise anyone to buy a nameless grid leak.

Bad contacts are responsible for many of the crackling noises heard in valve receivers. See that all the valves fit tightly in their sockets; separate the prongs a little with a pen-knife so that they make a tight fit in the sockets. Coil-holders and plug-in coils are apt to produce loud clicks more often than crackling noises; here, again, the pins should be scraped and care should be taken that they make good firm contact with their respective sockets.

Variable condensers are apt to cause crackling noises due to plates touching or due to the scraping of the moving part on a metallic dial.

Here, again, the noises are produced chiefly when the variable condenser is moved, and this is sufficient indication of where the trouble lies. The condenser usually gives very little trouble, if of reputable make, but the possibility of the fault in the condenser should not be overlooked. In most condensers the connection to the moving vanes is unreliable.

Inter-valve transformers are responsible for a good many of the noises in the valve receiver; faulty insulation of the windings will account not only for crackling noises, but also fizzing noises. The transformers, however, should not be forthwith changed unless one is certain of the trouble; there are other possible sources of the noises.

A general cause of noises is faulty insulation of the apparatus; a certain amount of the ebonite on the market is of poor insulation and allows leakage across its surface. This may be particularly troublesome in a valve holder.

Microphonic Noises.

Microphonic noises are frequently obtained in wireless receivers. These noises are generally due to vibration causing the grid of the valve to rattle slightly, the result being a variation of the anode current. The same effect may be obtained by tapping a valve. This microphonic effect can be readily eliminated. The set may be mounted on rubber feet or, better still, on a piece of rubber sponge. When a crystal is being used in conjunction with valves, microphonic noises are often caused through vibration varying the pressure on the crystal. This is particularly likely to occur if the pressure

inside the valve itself; this coupling is due to the small condenser formed by the grid and anode of the valve, and also to the leads going to these electrodes. Moreover, it is difficult, in most cases, to avoid a certain amount of magnetic coupling between the inductances in the grid and anode circuits.

In all circuits using valves which act as high-frequency amplifiers, self-oscillation is likely to be set up. Once the valve is oscillating, squeals and howls are inevitable. The reason for this is that, although, while the valve is oscillating at high-frequency and no signals are coming in, no noise is heard, yet when neighbouring sets are also oscillating, or when one is listening-in to broadcasting, the two sets of currents interfere with each other, producing beats which are rectified by the receiver and produce the howling noises heard.

Whenever two sets of alternating currents are made to combine, a third resultant current is produced. If the two sets of currents have exactly the same frequency, the resultant current, due to the mixing of the two separate currents, will be an alternating one, still of the same frequency, but having a strength of or magnitude depending upon special circumstances. If, however, the two alternating currents have a different

frequency, the resultant current will be an alternating one, but its magnitude will increase or decrease at regular intervals. There will be humps, or beats, occurring at a frequency which will equal the difference in frequency between the two interacting currents. Thus, if one set of current has a frequency of 1,000,000 and the other has a frequency of 1,001,000 the beats or increases in the resultant current will occur at the rate of 1,000 per second. These beats, when detected by a wireless receiver, will give a musical note in the telephone receivers.

The principle of the reception of continuous waves is the utilisation of local continuous oscillations generated by a valve to combine with incoming oscillations.

When receiving telephony signals, however, this interference effect is not wanted and causes musical sounds which will vary in pitch according to the adjustment of the receiver. These musical notes, which are given very different names in actual prac-

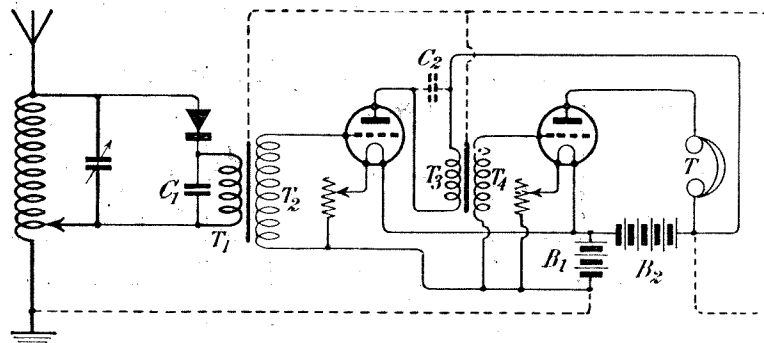

Fig. 1.—The dotted lines show the connections which frequently minimise or eliminate undesirable noises in valve receivers.

between the two crystal electrodes is light. As heavy a pressure as possible without sacrificing signal strength should be used.

Noises Due to Heterodyning.

Probably the most common trouble which the beginner experiences is the howling due to his set oscillating. A valve will oscillate or generate alternating currents of high-frequency whenever there is sufficient transference of high-frequency energy from the anode circuit to the grid circuit. This transference of energy, as explained in a previous article on reaction, may be accomplished either intentionally or unintentionally. When it is done intentionally it is usual to have a reaction coil coupled to another inductance, usually in the grid circuit of the same or a preceding valve. This reaction, if made too tight, will cause the valve to oscillate of its own accord. Even though no direct coupling is effected, yet, nevertheless, self-oscillation may be set up, due to the inherent capacity coupling

ti ce, are simply caused by the locally generated oscillations interfering with the carrier wave of the broadcasting station. The signals, of course, sent out from a broadcasting station are continuous waves, the magnitude of which is caused to vary up and down by the speech or music being transmitted. The carrier wave sets up continuous oscillations in the receiver which, if already oscillating at a frequency close to that of the carrier wave, will cause the musical notes which will interfere with the reception of the music or speech. These musical notes are really the undesired howls sometimes heard on a receiver, and a variation of any of the tuning adjustments of the receiver will vary the frequency of the local oscillations generated by the receiver, and so vary the pitch of the howling noise.

If then, when varying, say, your variable condenser, a whooping sound is heard, or a chirp, when listening to broadcasting, it is a clear indication that one of your valves is oscillating. If reaction is being used, the reaction should immediately be loosened by separating the two coils, until a variation of the condenser fails to produce the previous noise.

It may be that even when no broadcasting station is working, a variation of the receiving condenser will cause a chirp to be heard. This is probably due to some other receiving station in the neighbourhood radiating feeble continuous waves with a set which, through carelessness or ignorance, is being allowed to oscillate.

If your set is at a fixed adjustment, and you hear, while listening to broadcasting, a distinct chirp which varies in pitch, the trouble is caused in all likelihood by the waves emitted from a neighbouring oscillating receiver heterodyning, or combining, with a carrier wave of the broadcasting station and producing the undesired beats. Nothing can be done to prevent this, except a complaint to the neighbour, who usually cannot be definitely identified.

It is as well to remember that if when you vary your condenser or make some other adjustment in the receiver, a howl is produced, the chances are about ten to one that your neighbours are hearing the same noise and having their reception completely spoiled.

Self-oscillation may be prevented in various ways, and details have been

given in previous articles in this series.

Low-frequency Oscillations.

A form of interference which occurs in receivers using more than one low-frequency inter-valve transformer is that due to low-frequency oscillations. These are due to unintentional and undesired reaction effects taking place from the anode circuit of one valve to the grid circuit of the preceding valve, or even to the grid circuit of the same valve. The effect is very rarely noticed when only one low-frequency amplifying valve is used, except sometimes in the case of dual amplification or reflex circuits. When two valves are used as low-frequency amplifiers low-frequency oscillation not infrequently takes place, and as these oscillations are usually of audible frequency they cause serious interference. This interference, however, does not extend to neighbouring

windings of one of the transformers. In other words, try reversing the leads to, say, the primary of one of the transformers. If there was formerly a slight reaction effect which produced self-oscillation, reversing the leads should result in a slight reverse reaction effect which should keep the amplifier stable. There is no reason, however, why a low-frequency amplifier should oscillate when a good quality of inter-valve transformer is employed.

Fixed condenser of .0002 μ F capacity may be connected across the primaries or secondaries. One condenser alone will stop self-oscillation. The connection of 100,000 ohms resistances across the secondary windings will also frequently provide a remedy.

In bad cases, relief may sometimes be obtained by connecting all the iron cores together by means of a wire which is connected to the positive terminal of the high-tension battery or to earth.

The use of a large condenser across the high-tension battery is always to be recommended, and this condenser should have a capacity of not less than 1 μ F. A high-tension battery always possesses a certain amount of internal resistance, and this is particularly the case when the battery has been in use for some considerable time. By connecting a condenser of large capacity across the high-tension battery, we provide a by-path, not only for any high-

frequency currents, but also for low-frequency currents. The potential differences set up across the high-tension battery and condenser by low-frequency currents will be negligible, whereas, if no condenser were employed, quite considerable potential differences would be set up across the high-tension battery and might give rise to undesired and obscure reaction effects.

Intermittent Self-Oscillation

A very common source of howling noises, buzzing and ticking is the intermittent oscillation of a valve at a high frequency. This intermittent oscillation is rarely mentioned in technical journals, and the noises heard are very often attributed to other less guilty causes.

These noises are generally caused by using grid condensers and grid leaks of incorrect value or by the use of excessive reaction. They are also often due to disconnections or the use of too small a value of a series condenser in the aerial circuit.

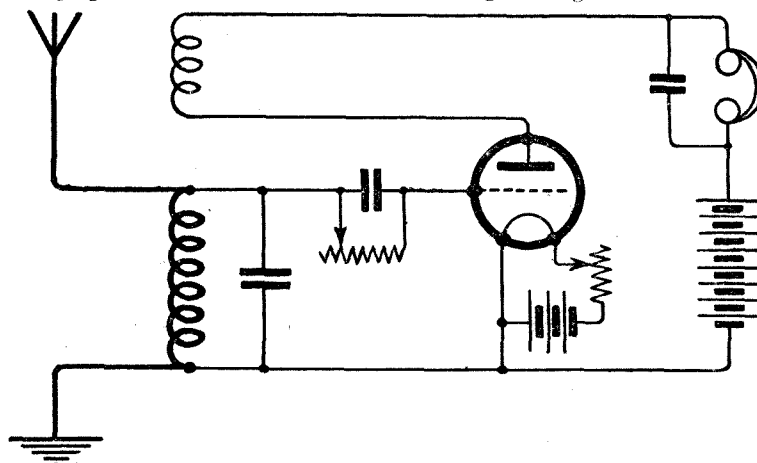

Fig. 2. A circuit in which howling is easily set up with different values of grid condenser and leak.

stations. A variation of the tuning will not usually affect in any way the pitch of the note heard.

In dual amplification circuits, however, and sometimes in more ordinary circuits, a tightening of the reaction will cause the low-frequency portion of the circuit to oscillate. This generally occurs when the high-frequency valves begin to oscillate, and the low-frequency valves follow suit.

To prevent low-frequency oscillation taking place there are several rules to be observed. In the first place, the valves, acting as low-frequency amplifiers, should operate about midway along their characteristic curves. The transformers should be kept as widely separated as possible, but if boxed up in a set, the relative positions of the transformers should be varied in order to find the position which causes least coupling between the transformers.

Low-frequency oscillation may usually be prevented by reversing the

were times when his signals seemed to have lost all their wonted power. Then in the days of one's inexperience one would reach hastily for screwdriver and pliers and indulge in an orgy of vivisection amongst the various panels. After half an hour or so of worried search one would find no fault anywhere. Why? Well, simply because there was none to be found. The North Foreland station has a little way of working at times on about half its normal power; a scurvy trick to play on the unsuspecting enthusiast who feels unhappy if he can detect the slightest falling off from the normal strength of his receptions.

Always Something New

On 600 metres you never know what you are going to pick up. You may hear nothing but the most ordinary of messages betwixt ship and ship, or ship and shore. You may test your linguistic abilities by taking down transmissions in almost any civilised language and afterwards translating them. Little bits of comedy occasionally occur. A message I picked up a short time ago in German ran: "Have been grievously sea-sick, darling, but am now eating well." Sometimes one hears little but weather reports, or messages that such and such a ship has left port; but the most dramatic moment of all is when for the first time you hear the SOS. Every big station is engaged for a second or two in shutting up all ordinary transmission. The last time that I heard the SOS, silence was obtained in less than three-quarters of a minute. One could not hear the distressed ship herself, but all that she sent out was relayed on by a West Country station.

The Miracle of Wireless

It is things of this kind that make one realise the great wonder of wireless. There was a vessel in difficulties miles away from land, yet her call for help was picked up, encouraging messages were sent

back, and within a few moments the land stations were engaged in getting hold of other ships in the neighbourhood of the cripple and in sending them to her aid. A few short years ago such a ship would have had no means of communication with anyone who could not see her rockets. Now she can send out her cry for help and feel sure it will be heard far and wide.

The Voice of America

One of the greatest surprises if you are new to 600 metres will come in the form of a sudden burst of iddy umpties that nearly shatters

from the loudspeaker as I proved by leaving the window open and moving further and further away.

Subdued Howling

The fellow who used to howl loudly on broadcast receptions has now been more or less silenced by the torrent of abuse poured out upon his kind at meetings of wireless clubs, and by the stinging remarks on the subject that have appeared in MODERN WIRELESS and other papers. But there is still with us a criminal who in order to get the last ounce of work out of his 'phones boosts up the reaction until his set is just short of the howling point. He does not actually howl, but his set is in mild oscillation, with the result that all his neighbours within a considerable radius received an undercurrent of faint whistles or moans. This sort of thing is grossly unfair, for it absolutely ruins reception, and the worst of it is that everyone else on hearing those faint but offensive sounds suspects his own set and promptly proceeds to make adjustments, with the result that he probably gets his apparatus into oscillation, at any rate for a time. The worst fellow of all is he who is never quite satisfied with his tuning. He sits before his set and is obsessed with the idea that he can make things just a little better. He is constantly fiddling with condensers, couplings, rheostats and H.T. voltage, and his

set is always falling into oscillation, whose effects are passed on all round the district. It is a natural instinct, for we all want to have things at their best. But if you are one of the victims of the passion for making adjustments, do remember that you have neighbours. Once you have picked up a station with good signal strength be content to leave well alone, and don't be forever fiddling with the controls.



the drums of your ears. This you may pretty safely put down to an American ship, for some of them use enormously powerful transmitting gear, working no doubt on the principle that if you want to be heard you must speak up. Some of them drown all other stations when they are working, and what their input must be I have no idea—it must be something fairly useful. One that chipped in the other day for a time was plainly audible and readable 200 yards

A SIMPLY MADE CRYSTAL RECEIVER.

By D. THEWLIS.

An article of interest to those who desire to construct a neat and efficient crystal receiver.

GENERALLY speaking, when a prospective new member of the wireless fraternity first feels the call of the ether, the main consideration with him, or her, is cost. The very great advantage of the crystal set, of course, is that once it is installed there is nothing to pay for its upkeep.

The crystal set about to be

- Switch arms complete (2).
- Switch studs (21).
- Terminals (4).
- No. 26 gauge D.C.C. wire.
- Cardboard tube measuring 4 ins. long by 3½ ins. diameter.

General Remarks

The exact arrangement of the parts is not very important, but the

L2 is tapped at every turn for fine tuning. The two switches on top are for taking tapings from two coils inside the box.

Construction of the Set The Inductance Coil

Fig. 3 shows the inductance coil. The cardboard former, measuring 3½ ins. diameter and 4 ins. long, was wound with 100 turns of No. 26 gauge double cotton covered copper wire; tapings were taken at every ten turns for coarse tuning. It will be seen from the figure that a further 9 turns of inductance are wound on the cardboard tube, separated from the other winding by a distance of about ½ in. This second winding is tapped at every turn to enable finer tuning to be obtained. After the tapings were taken to the various studs, a brass strip was fastened to the back of the lid of the box and fixed to the underneath of the inductance coil as a means of supporting it.

The Crystal Detector

The crystal detector is shown in Fig. 4 and was purchased. It is

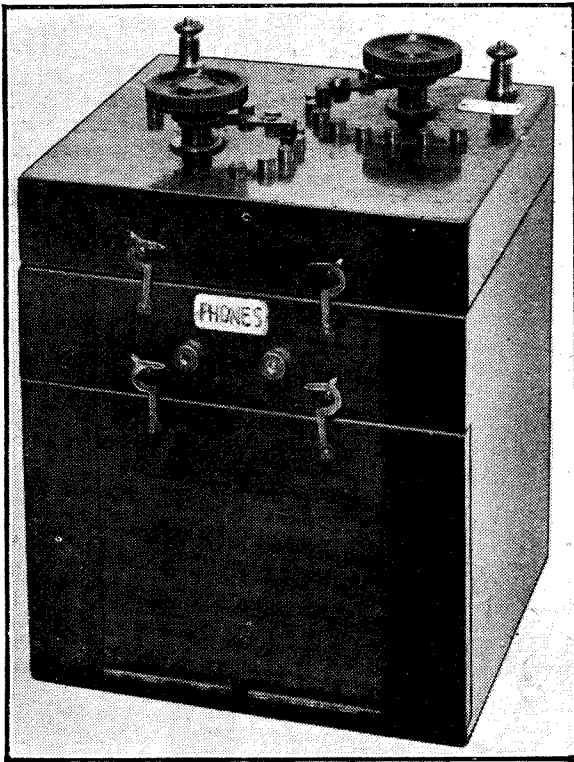

Fig. 1.—The complete instrument.

described has proved very efficient and the actual cost, to the writer, was 10s. exclusive of the telephone receivers.

Components Required

- Box with hinged lid and drop front.
- Crystal holder.
- Crystal (hertzite).

number of turns, etc., on the coil should be adhered to. Any suitable box may be used. Fig. 1 is an illustration of the completed set.

Fig. 2 shows a circuit diagram of the set and it will be seen that the coil L2 is separate from L1, but wound on the same tube. L1 is tapped at every ten turns and

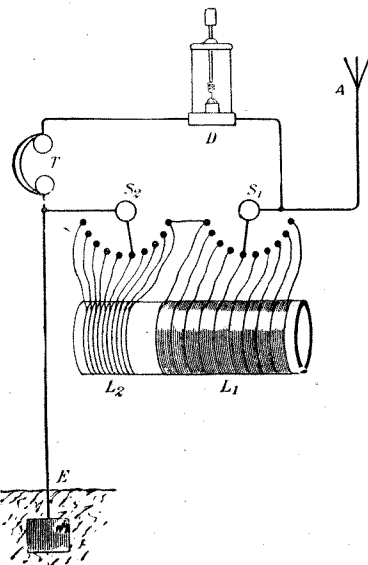

Fig. 2.—The circuit diagram.

preferable to buy a holder with a glass casing to protect the crystal from dust. Wood's metal was used for fixing the crystal in the cup and, although not always the best attachment for a crystal, it afterwards proved to work extremely well. The holder was fixed to an ebonite strip and attached to the left-hand side of the box inside.

After all the necessary parts were obtained, the top of the box was carefully marked off to receive the switch arms and studs. This, a

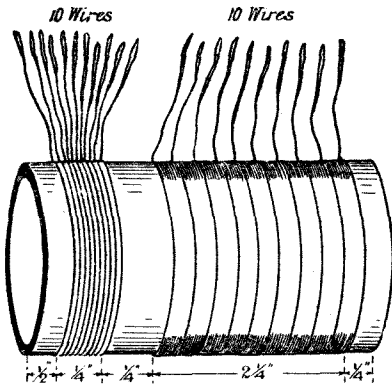

Fig. 3.—The inductance coil.

first, may appear a delicate business, but the writer found that by marking off the positions on a piece of fairly stout notepaper, and laying it on top of the box, it was quite a simple matter to prick through all the necessary drilling centres in their correct positions. An ordinary hand brace was used and the wood being thoroughly dried and seasoned, it was not found necessary to alter the box by putting an ebonite panel in, the

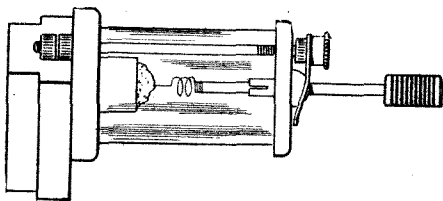

Fig. 4.—The crystal detector.

switch studs and arms being mounted on the top of the box itself.

It was found advisable to slightly round off the top edges of the studs to ensure a smooth contact with the switch arm. The aerial and earth terminals were mounted on the lid of the box and the various tappings connected to their respective studs, as shown in Fig. 6 which shows the general wiring. In this figure the inductance is

shown much smaller than it really is, for the sake of clearness.

Two leads were taken from the aerial and earth terminals; the

so as to be in an easily accessible position for adjusting, besides presenting a neat appearance. The second terminal of the crystal

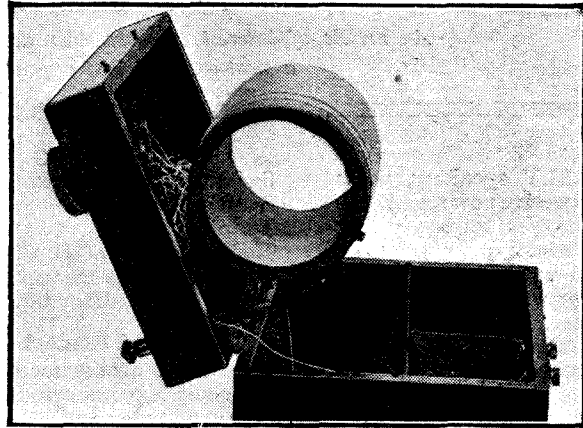

Fig. 5—Showing the mounting of inductance tube.

latter was connected to one of the 'phone terminals, which was mounted on the front of the box, and the former was connected to one of the terminals of the crystal detector, which was mounted just inside the drop flap in the front of the box,

detector, of course, was connected to the remaining 'phone terminal.

Fig. 1 shows the set when completed. To add to the appearance of the set, it was thought an investment would be made by visiting the local railway station and stamp-

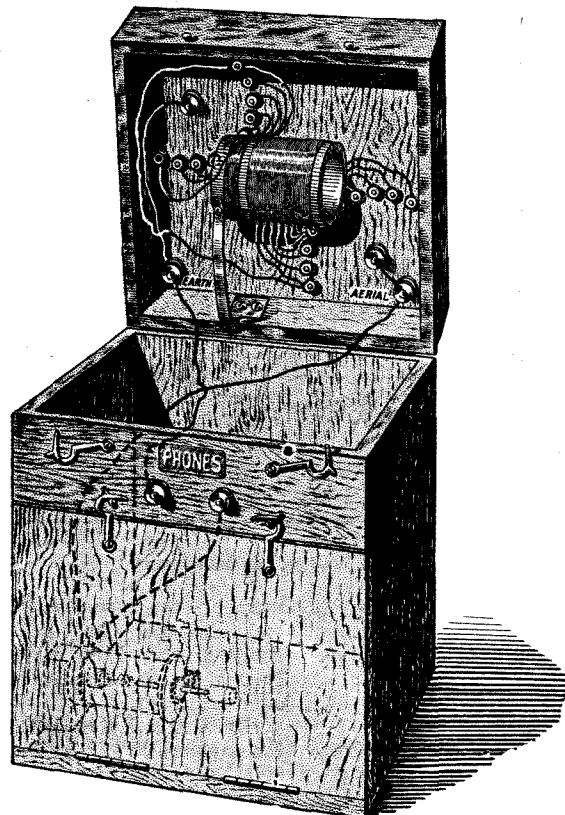

Fig. 6—How the set is wired.

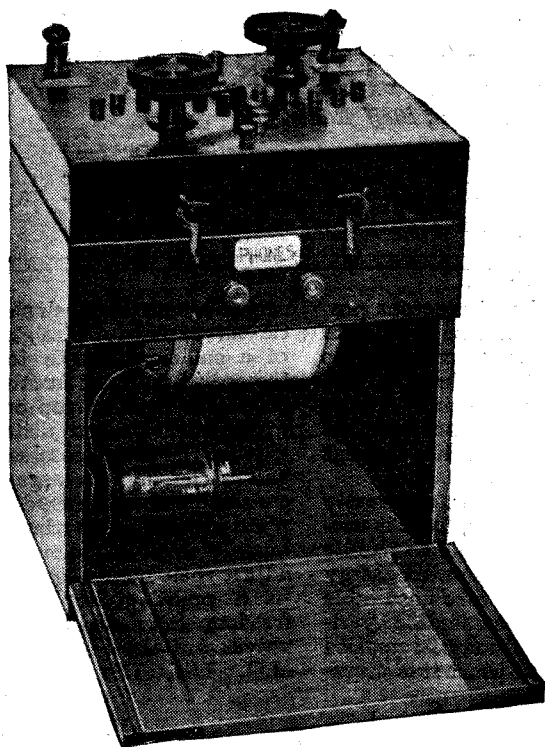

Fig. 7.—The complete set with the flap open.

ing "Phones," "Aerial" and "Earth" labels on the name-plate machines to be found there.

Figs. 5 and 7 are photographs of the set showing in the first case how the coil is placed, and in the second case the view when the drop flap is lowered.

Results

The set has been tested on a small aerial about 12 miles from the London Broadcasting Station, and is in continual use, giving excellent results.

As will be seen from Fig. 1, the set is very neat and compact in appearance, and one advantage over many broadcast receivers is the range of wavelengths, as this set was found to tune up to Croydon Aerodrome on 900 metres quite well.

A Correction.

Owing to a slight defect in the block of Figure 2, page 458, of MODERN WIRELESS for July, the wire connecting the central point of the lower half of Switch "Q" to the bottom wire is not shown in the copies as printed. Without this wire the switch will not function in the way intended.

WOULD YOU LIKE THE POSITION?

A Difficult Job

Would you like to be one of those responsible for broadcast programmes? Personally there are many jobs involving real hard work that I would far rather have. In fact were you to offer me a princely salary (which is to say the least of it unlikely) to become one of them I would refuse incontinently, preferring, like Horace of old, my country house and a life of comparative quiet. No matter what these unfortunates do they are for it. They receive a number of communications asking for a lighter and brighter programme.

Obligingly they provide it. Next morning thousands of letters and postcards are received saying that no one wants to listen to that kind of tosh. With a stifled sigh they order round the Wagner orchestra. Promptly they are told that no one likes high brow stuff. Lectures are asked for. They put them on, only to hear from all parts of the country that no one wants them. Give them Shakespeare, and they clamour for musical comedy. Turn on musical comedy, and they want something more serious. Those who listen in appear to have the idea that each of them should be able to appreciate and enjoy every

single item of the programme. This is, of course, absolutely impossible, for what is one man's meat is another man's poison. "Don't shoot at the performer; he is doing his best," used to be the notice displayed in the saloons of Arizona in the wild, woolly and wet days. It might now be placed at the head of broadcast programmes published in the daily press. We are all entertained by ninety per cent. of what our sets bring in when we tune to any broadcasting station's wavelength. It saves both current and temper to switch off if an item comes along that you do not like. R.W.H.

A POWER AMPLIFIER

By G. P. KENDALL, B.Sc., Staff Editor.

Much harm is being done to the wireless art by public demonstrations of "loud speaking" with overloaded and entirely unsuitable equipment. In this article the writer explains very clearly why the distortion occurs and how an excellent power amplifier can be built which will really do justice to the present excellent broadcasting.

IT seems that there is some misapprehension on the part of many experimenters and listeners-in as to the true nature of what is known as "power" amplification. There appears to be a tendency to regard it as something mysterious in a box, which box is only to be obtained at a high price from certain of the firms which have specialised in sound reproduction on a large scale.

Actually, of course, there is nothing mysterious in the process: it is simply low-frequency amplification carried out with apparatus designed to handle larger amounts of energy than the ordinary notemagnifier can deal with satisfactorily. Its use, as is fairly well known, is to provide comparatively large output currents for working loud-speakers in large rooms or halls, such large outputs being produced without the distortion which would result from over-loading an ordinary L.F. amplifier to give a corresponding amount of power.

In designing an amplifier to carry considerable amounts of energy little departure from normal practice is entailed, the principal modifications being concerned with the choice of suitable components to carry the relatively large currents. The intervalve transformers, for

example, must be of generous proportions, and should be of a make guaranteed to carry considerable currents without over-heating, and to have withstood a testing pressure of at least 500 volts between the windings and between the windings and the core.

The valves, however, are really the crux of the matter, for it is useless to expect to be able to handle large amounts of modulated energy with small or otherwise unsuitable valves. Quite considerable variations of potential may be applied to their grids and hence it is neces-

sary to ensure that their characteristic curves have a straight portion of a sufficient length to prevent the operating point from travelling round the bend at top or bottom, which would produce distortion.

It is, therefore, necessary to use valves having a large filament emission and correspondingly large plate current, give them an adequately high plate voltage, and adjust their normal grid potentials to a point giving the greatest freedom from distortion. Suitable valves are the Mullard P.A., the M.O. LSr, LS2, and LS3, the ex-army "B" type, or any small transmitting valve. The actual value of plate voltage required will obviously depend upon the valves, but will usually be between 200 and 500 volts, while the grid potential will have a negative value of from 2 or 3 to 50 volts.

A further point which must be taken into account when designing power amplifiers is the greater tendency of such instruments to self-oscillation. Care must be taken to space out the transformers and separate the wiring as much as possible. The usual points, such as the spacing out of grid circuits from plate circuit wiring, reversal of windings to give the best results, and so forth, should be attended to most

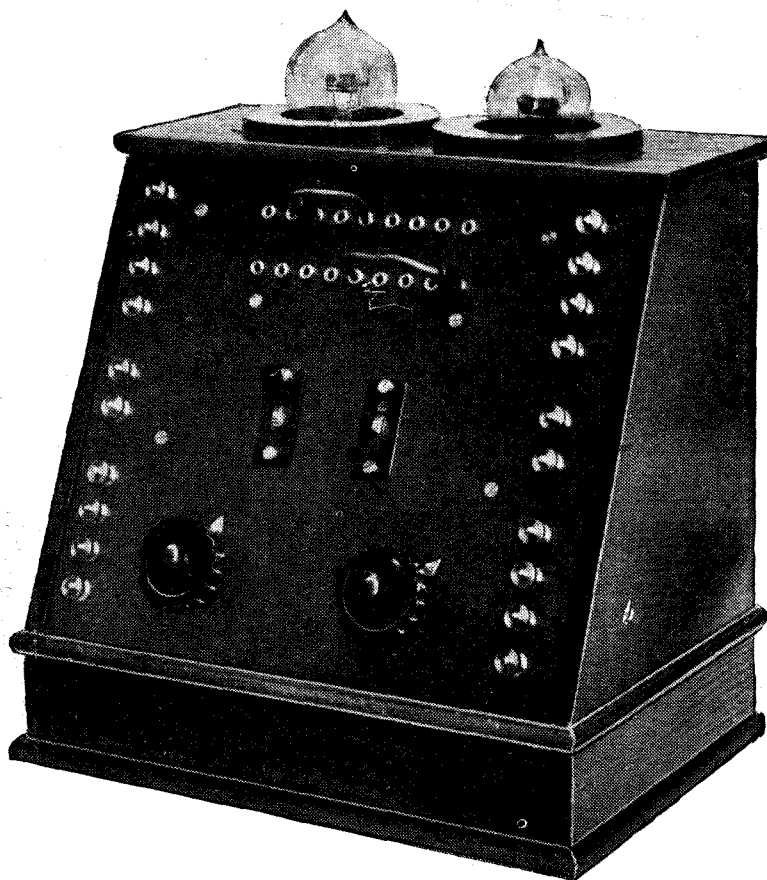

Fig. 1.—The completed instrument.

scrupulously; remember that considerable currents will be flowing in the various leads, and therefore inter-action effects will be more troublesome than in a low-frequency amplifier of ordinary type. For this reason it is usually well to limit power amplification to two stages, which will give ample output for all normal purposes.

The power amplifier described in this article has been carefully designed with these points in mind, and provides a good example of a successful type. It is a useful instrument, whose construction can be recommended to anyone desiring to possess a really good L.F. amplifier. If maximum output is not required ordinary R or similar hard valves can be used with about 100 volts on the plates and -2 to -6 volts on the grids, whereupon the instrument will function as a note-magnifier of considerably more than average efficiency.

Circuit

A simplified circuit is given in Fig. 5, from which it will be seen that a standard L.F. circuit is employed, with transformer coupling. Separate filament resistances and H.T. feeds (both desirable features) are provided for each valve, and a battery of small dry cells, B_3 , is included for the separate adjustment of the potential of each grid by means of two wander-plugs and a double row of sockets.

The secondary windings are shunted by anode resistances, R_1 and R_2 , of 80,000 ohms each. The effect of these shunts is to flatten out the natural resonance peaks of the windings and give much improved purity of reproduction. Their resistance is not very critical,

but since they reduce signal strength somewhat it is worth while to experiment with them a little and determine the actual best value: in some cases 100,000 ohms will be found preferable, and in any case the interchangeable pattern should be used, so that they can always be readily exchanged.

Switching

The switching of the amplifier is of a somewhat complicated nature, and would be unjustifiably so were it not that it has been carefully worked out to eliminate objectionable effects. Dewar switches are used to bring the valves into circuit as required, and their functioning is as follows: Both switches *up*: Both valves cut out and the input terminals connected through to the output. Left hand switch *down*, right hand switch *up*: first valve brought into circuit, giving one stage of amplification. Left hand switch *up*, right hand switch *down*: second valve brought into circuit, giving one stage of amplification as before, but by means of the other valve.

This arrangement permits two

different types of valves to be compared and their relative merits determined with great ease. Both switches *down*: both valves in circuit, giving two stages of amplification. It should be noted that the central positions of the switches are not used.

The arrangement for adjustment of grid potential consists, as previously stated, of two wander-plugs and a double row of sockets. These sockets may be seen in a row across the top of the panel in Fig. 1. Number one pair of sockets are connected to the negative ends of the

filaments, number two pair to the negative ends of the filament resistances, and the succeeding pairs to points along a battery of dry cells.

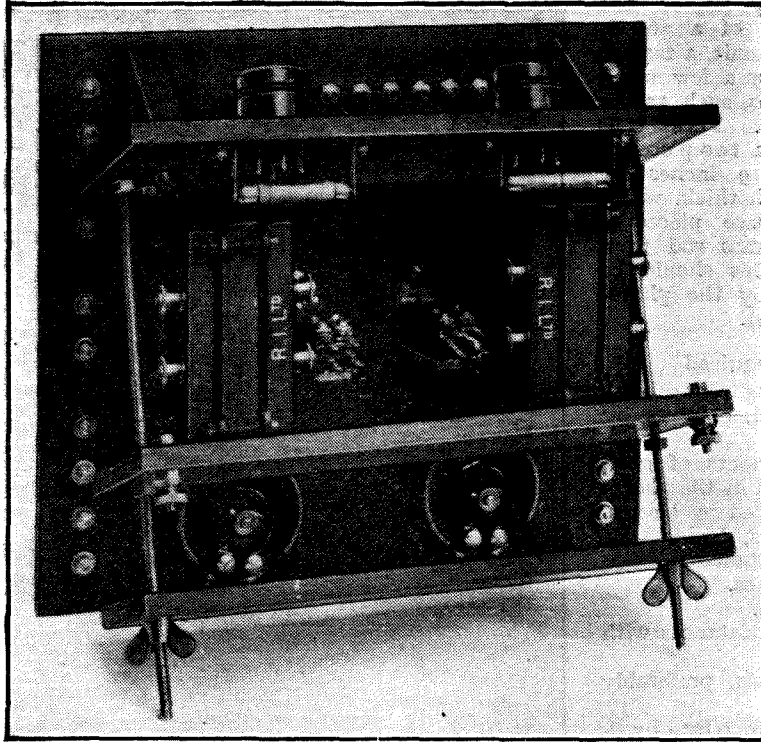

Fig. 2.—The back of the panel before wiring up.

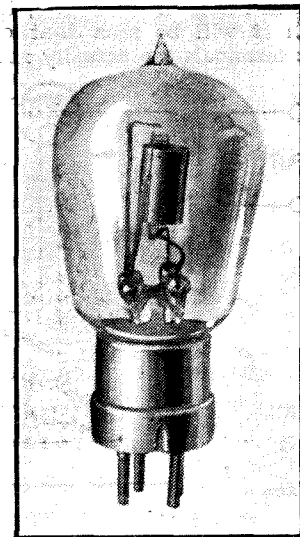

Fig. 3.—A small Mullard transmitting valve, suitable for power amplification.

This grid battery (B_3 in the figure) may consist of a 36- or 30-volt tapped H.T. unit, a tapped 15-volt strip unit, or a few small square separate cells, such as the Siemens "S" size. These cells are clamped between two pieces of ebonite measuring 9 inches by 3 inches and $\frac{5}{16}$ inch thick, which are suspended by two pieces of 2 B.A. threaded brass rod from the valve shelf. This should be made quite plain by the photographs (Figs. 2 and 4).

Materials Required

- 1 Polished sloping front cabinet
- 1 Ebonite panel, 9 by 10 by $\frac{5}{16}$ inch.
- 2 L.F. transformers of good make (those seen in the photographs were supplied by Messrs. Radio Instruments, Ltd.).
- 2 Filament resistances.
- 2 Dewar switches.
- 2 valve sockets.
- 2 80,000 ohm resistances with clips.
- 8 Brass terminals, preferably lacquered.
- 1 piece of ebonite, 9 by 4 by $\frac{5}{16}$ inches.
- 2 Pieces of ebonite, 9 by 3 by $\frac{5}{16}$ inches.
- 18 Gibson sockets.
- 2 Gibson Plugs.
- Screws, 20 gauge tinned copper-wire for connections, Systoflex, etc.

Panel

A dimensioned drilling plan of the panel is given in Fig. 6, from which it will be seen that only eight terminals are actually neces-

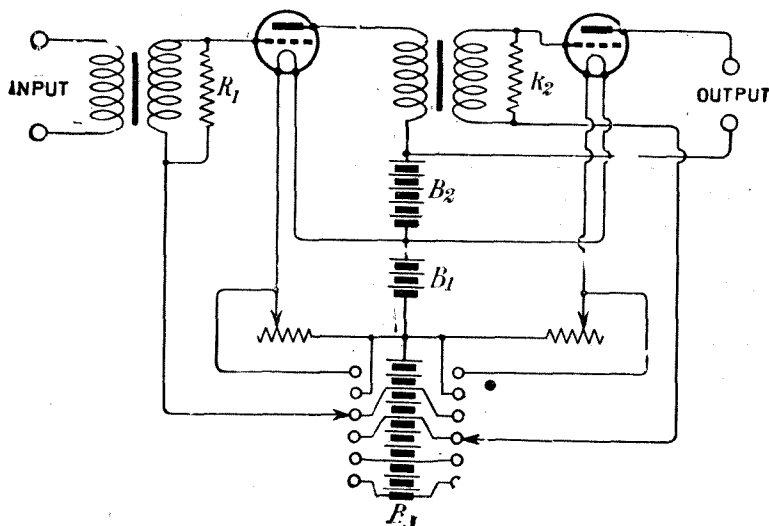

Fig. 5.—A simplified circuit diagram, omitting the Dewar switches.

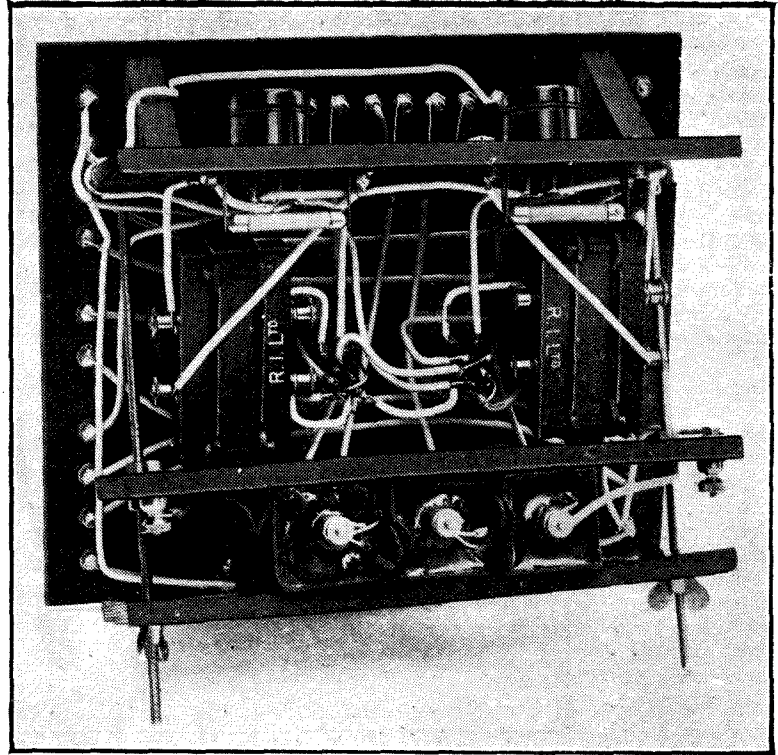

Fig. 4.—The back of the panel after wiring up, and with three grid cells in position

sary, as against the twenty seen in Fig. 1. The latter number was included in the case of the instrument constructed by the writer in order to take various battery leads through the instrument to connect with other terminals upon a high-frequency amplifier on its left. Of those shown in Fig. 6, 1 and 2 are

the input, 3 is LT-, 4 is LT+ and H-T, 5 is HT+ for the first valve, and 6 is HT+ for the second, while 7 and 8 are the output. If desired four more terminals might be placed symmetrically upon the left-hand side of the panel and connected through to Nos. 3-6, in order that the batteries might be placed upon whichever side is most convenient. This modification would probably improve the appearance of the instrument.

Valve Mounting

The arrangement of the valves calls for some explanation, since it is of rather an unusual nature. They are carried upon a horizontal ebonite shelf, fitted to the back of the panel by means of two ebonite brackets in the manner shown in Fig. 7. The dimensions indicated in this diagram, of course, will only be correct in the case of a cabinet of the same make as that employed by the writer, which, by the way, is a standard size and can consequently be obtained at a very reasonable figure.

The valves are inserted through two holes of $2\frac{1}{4}$ inches diameter,

4 inches apart, in the top of the cabinet, and occupy the position shown in the photograph (Fig. 1). These holes are desirably finished as to their edges by being bushed

Filament Resistances

Since valves of fairly large size may be used it is desirable that the filament resistances should be cap-

arrangement. The writer converted this latter device into a simple on-and-off switch, so that the filament current of each valve can be cut off without altering the setting of the rheostat: this is quite a convenience in using the set.

Wiring

The wiring of the amplifier should be done with some care, and all the connections should be well soldered. It should be mentioned in this latter connection that the leads to the shunt resistances should be soldered to the clips in which they are mounted, and *not* direct to their end-caps; this last method is often employed by overzealous persons, and may damage the resistances seriously.

The connections may be made with No. 20 tinned copper wire, and in view of their complexity it is desirable that they should be sleeved with Systoflex or some similar insulating tubing. (Why cannot someone invent a really descriptive name for such tubing which shall not be a trade term? In the States it is called Spaghetti, which is at least expressive.) A complete circuit diagram is given in Fig. 9, by the aid of which the wiring will be performed quite easily.

Operation of the Amplifier

The instrument is, of course, quite a simple one to use, but a few notes on its operation may assist its constructors to get the best out of it.

When it is used in conjunction with a set possessing several valves it is desirable to run it from a separate accumulator and a separate high-tension battery, since the demands which its large valves make upon the batteries are considerable. In the case of the high-tension battery the drain of receiving set plus power amplifier would be so heavy as to run the battery down quickly, and also sometimes introduce objectionable inter-actions between the anode feeds of the various valves.

When the high tension battery is getting old the same inter-action

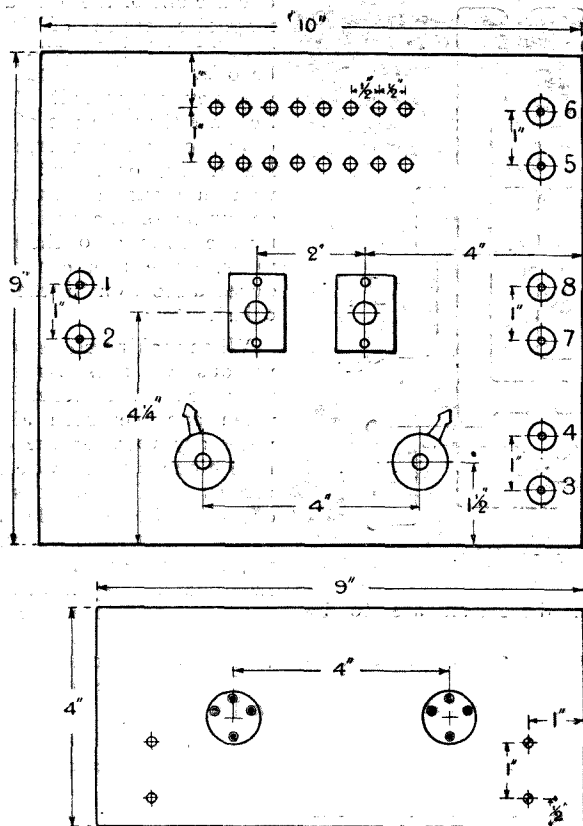

Fig. 6.—Plan of the panel (above) and the valve shelf (below).

with large ebonite or erinoid rings of the section shown in Fig. 8.

The valve shelf also carries the two shunt resistances, whose positions are clearly shown in Fig. 2.

able of carrying at least an ampere each without over-heating.

Those employed in the set illustrated are of a pattern whose central knob operates a vernier

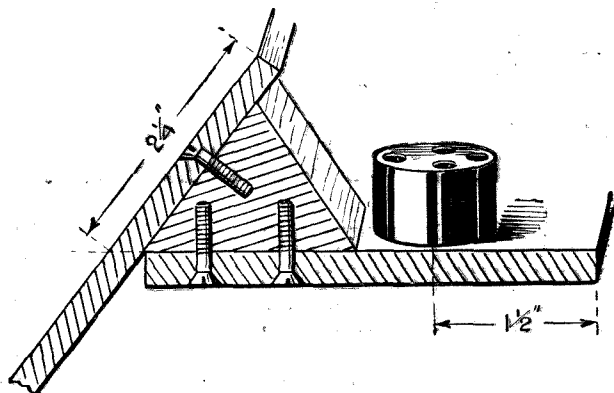

Fig. 7.—Method of attaching valve shelf to panel with small ebonite angle-pieces.

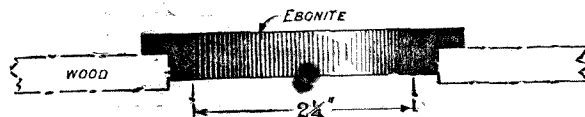

Fig. 8.—Erinoid bushing for valve holes.

may take place between the two amplifying valves, and the usual remedy of $1\mu\text{F}$ condensers across the H.T. terminals should be applied.

When the amplifier is connected directly to a detector circuit without

give very nearly as great amplification, with considerable economy of filament current and first cost. The second valve should in all cases be a power valve if the greatest possible volume and free-

quately here, but it is advisable to warn all possible users of the instrument that when supplied with fairly strong signals from the receiving set it is capable of giving an output much too powerful to operate one of the ordinary electromagnetic types of loud-speaker satisfactorily; the loud-speaker will be over-loaded and bad distortion will inevitably result. The remedy lies in either the use of an electrodynamic loud-speaker, such as the Magnavox, or a judicious reduction in signal strength by slight de-tuning of the aerial circuit (not by the reduction of the filament currents, since this expedient introduces distortion in the valve circuits).

When making adjustments of the various voltages remember that they are all inter-dependent, in that when one has been altered it is necessary to alter the others also before one can tell whether an improvement has or has not been effected. For example, if the plate voltage is raised by, say, 50 volts, there may be little or no increase in signal strength, but distortion may be introduced. If, however, filament current and negative grid bias be both increased proportionately the expected improvement will appear.

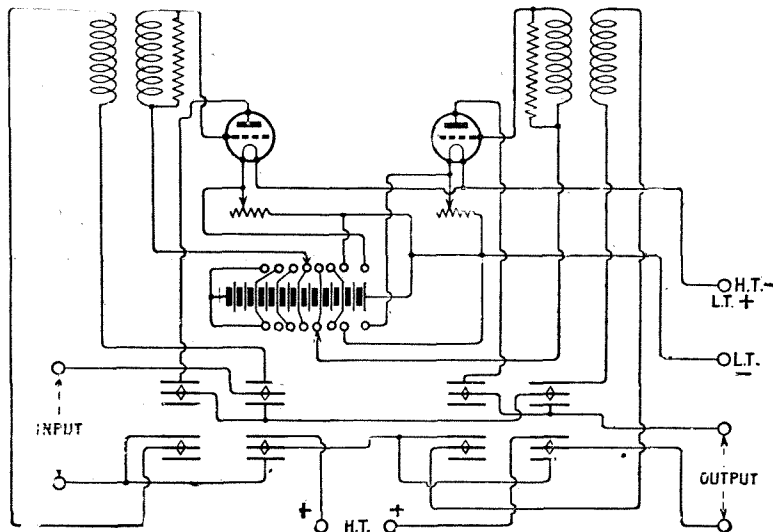

Fig. 9.—Complete circuit diagram of the amplifier.

the interposition of any note magnifying valves it will not usually be necessary to use a power valve in the first stage. An R valve with 80 to 140 volts on the plate will

dom from distortion are to be obtained.

The question of a suitable loud-speaker to use with the amplifier is too wide a one to deal with ade-

IMPORTANT NOTICE.

The September issue of
“MODERN WIRELESS”
 will be a Special
“HOW-TO-MAKE” Number.

*Full particulars will be given of HOW TO
 MAKE ALL KINDS OF RECEIVERS for
 the coming AUTUMN WIRELESS BOOM.*

ORDER YOUR COPY IN ADVANCE!

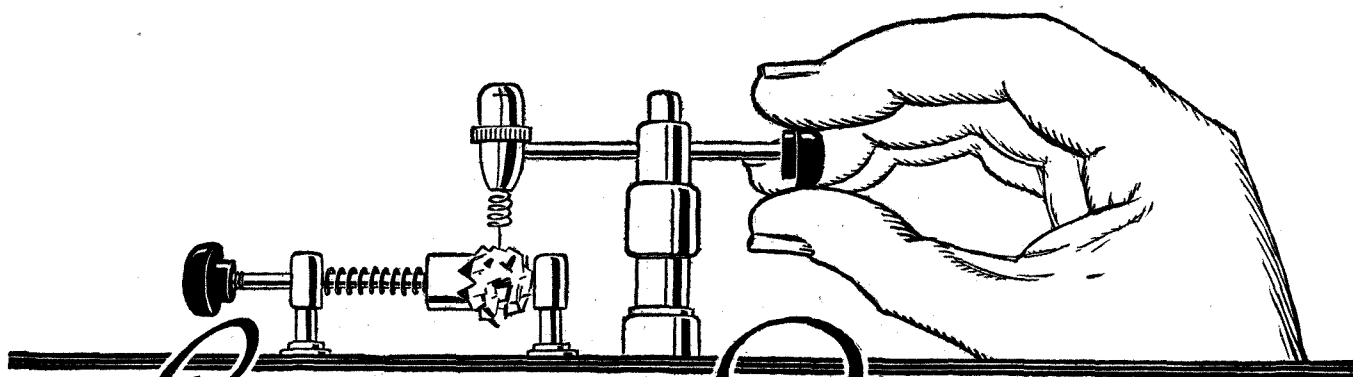

Crystal Points

ON several occasions recently the writer of these notes has been asked to examine crystal receiving sets which have not been giving good results. Nearly always the trouble has been entirely due to the "cat-whisker." Many receiving sets are fitted with cat-whiskers which are much too thick to give satisfactory results with crystals of the ordinary type, and in most cases the wire is of copper or brass, both very easily oxidisable metals. Now it is necessary that the contact of the wire on the crystal should always be quite clean and bright. If the metal is oxidised in any way, the oxide forms an insulating covering on the tip of wire, and good results cannot be obtained. For this reason I recommend all users of crystal sets to fit gold wire cat-whiskers to their detectors. Such wires are now obtainable from any reputable dealer at prices ranging from fourpence to one shilling; there is no need to delay fitting them on the grounds of expense. Not only are these wires of finer gauge than is usually fitted to detectors (this in itself is an advantage), but the non-oxidisable nature of the gold ensures the point remaining in good condition for far longer periods than would otherwise be the case.

* * *

What has become of the pre-war range of crystals which we "old-stagers" used so successfully? Silicon seems to have disappeared almost entirely from the market, or at least is not generally fitted nowadays.

Fused silicon proved a very good detector and maintained its sensitivity for long periods. The writer's impression is that it kept its adjustment for longer periods than either galena or any of the treated galena crystals which now masquerade under so many trade names. Some of us used to obtain excellent results by a contact between a piece of lead pencil and silicon, although the usual cat-whisker wire serves almost as well. Good specimens of iron pyrites were frequently found to be very sensitive, and in pre-war times practically all of the French Government Stations were fitted with iron pyrites crystal detectors. An excellent brand of crystal of this nature used to be marketed under the name of "Feron," and was particularly popular in the United States. It does not seem to be available now.

* * *

Many of the popular crystals are very sensitive to the effects of heating, and therefore particular pains should be taken when mounting them. The standard method of mounting crystals is in "Wood's metal," an alloy containing lead, tin and bismuth. It is interesting to note that any increase in the proportion of bismuth reduces the melting point of a metal very considerably. Thus an alloy consisting of four parts of lead, four of tin and one of bismuth has a melting point of 320 degrees Fahrenheit, whereas one with eight parts of lead, four of tin and fifteen of bismuth melts at only 150 degrees Fahrenheit, or much lower than the

boiling point of water. Unfortunately many of the soft solders sold as Wood's metal have far too high a melting point. Even when the fusible metal melts at a low temperature it is quite possible to overheat it. The best method of mounting crystals is to break off the right amount of Wood's metal to fill the crystal cup, and then to hold a hot soldering iron or poker against the outside of the metal cup until it is hot enough to melt the metal inside. Immediately the alloy melts the crystal should be pressed into it with the aid of a pair of tweezers, avoiding pressing the surface of the crystal with the fingers. Genuine Wood's metal will hold the crystal quite tightly when it is set and the temperature will not be high enough to injure the crystal. As genuine Wood's metal is rather expensive and ordinary solder quite cheap, it is easy to understand that the higher melting point solders are often passed off on the unsuspecting wireless purchaser as Wood's metal.

* * *

When adjusting a crystal do not rub the wire contacts backwards and forwards across the surface to find the best point, but lift the wire and replace it every time it is necessary to move contact. This will avoid scratching the crystal surface and thus injuring its sensitivity.

* * *

One frequently hears the question "What is the best crystal to use for broadcast reception?" It is necessary to point out that there is no one crystal, or rather *type* of crystal, which can be unhesitatingly recommended throughout. So much depends upon the particular specimen and the way it is used. Most of the crystals sold are good, but, as is evident from the first paragraph in this note, a badly adjusted or oxidised cat-whisker may easily give trouble and create a wrong impression with the best of crystals. Some crystals seem to work best with a fairly firm contact of the cat-whisker, whilst others seem to need particularly light adjustment. Again, different parts of the same crystal may prove to need different adjustments. Many crystals seem to work excellently not with one point, but with three or four points together, such as can be made by soldering several pieces of the fine wire found in electric lighting flex on to the end of a thicker wire. The small brushes made in this way are easy to adjust and frequently improve reception.

High-resistance telephones always give the best results with crystal detectors, although when signals are strong it is quite possible to use low-resistance telephones of 120 ohms. The use of low-resistance telephones will do no harm whatever to the instrument, but low-resistance and high-resistance telephones cannot be used together in parallel, or the low-resistance telephones will take all of the signals and nothing will be heard in the other pair. If, however, they are joined in series in the manner described in the previous paragraph, both pairs can be used together, although the effect will not be so satisfactory as if both of the pairs were of the same resistance.

Long-distance reception with crystal detectors is often announced in the daily paper, and while normally 25 to 30 miles seems about the limit of successful reception from a broadcasting station with an ordinary aerial and the average crystal set, occasionally far greater distances than this are covered. In almost every case it will be found that there is no special virtue in the tuner, and no magic crystal has been discovered. Everything seems to depend on the particular locality, and in cases where such admirable results are obtained the substitution of other tuners and other crystals does not appreciably alter the result. There are of course many "dead" spots in this country, where for some reason or other it is extremely difficult to receive broadcasting satisfactorily. But there are also several particularly "live" spots, to which very little reference has been made. In some parts of the country extraordinary good results seem to be obtainable from distant broadcasting stations, and very frequently one hears of cases where broadcasting has been received from stations 100 miles away on a simple crystal receiver. Of course, a good aerial makes a lot of difference, but in the dead spots the best of aerials seem to be practically useless. No full explanation has yet been found to cover these peculiarities, and scientists have hardly accumulated sufficient data yet to investigate the matter thoroughly.

* * *

If you have a cat-whisker giving trouble, and which you suspect is oxidised, it is quite a simple matter to nip off the end of the wire with a pair of scissors and expose a new and fresh point. If this does not immediately improve matters the trouble can be looked for elsewhere.

A NEW HIGH-FREQUENCY AMPLIFYING SYSTEM

By JOHN SCOTT-TAGGART, F.Inst.P.

This article deals with a method of high-frequency amplification which has been found very effective in preventing self-oscillation between the valves, while maintaining an efficient degree of amplification for each valve.

THE essential principles of the method of high-frequency amplification described below were explained in the June 27th issue of *Wireless Weekly*. For the benefit of the few who do not read both periodicals, it would be as well to explain briefly the action of this bridge method of high-frequency amplification.

All high-frequency amplifiers

a potentiometer connected across the filament accumulator is commonly employed. The greater the number of valves used as high-frequency amplifiers, the greater is the tendency to the circuit to oscillate, this being due to the fact that the output currents, after several stages of amplification, are so great that even the small capacity effects, always present when the circuit is wired up, are

therefore, very important, if we are to develop the full degree of amplification for every valve in the amplifier, to lessen the tendency to oscillate in such a manner that there is no wastage of energy.

There have been two principal methods of preventing self-oscillation in high-frequency amplifiers. One of these methods was published in a British Patent Specification of the General Electric Com-

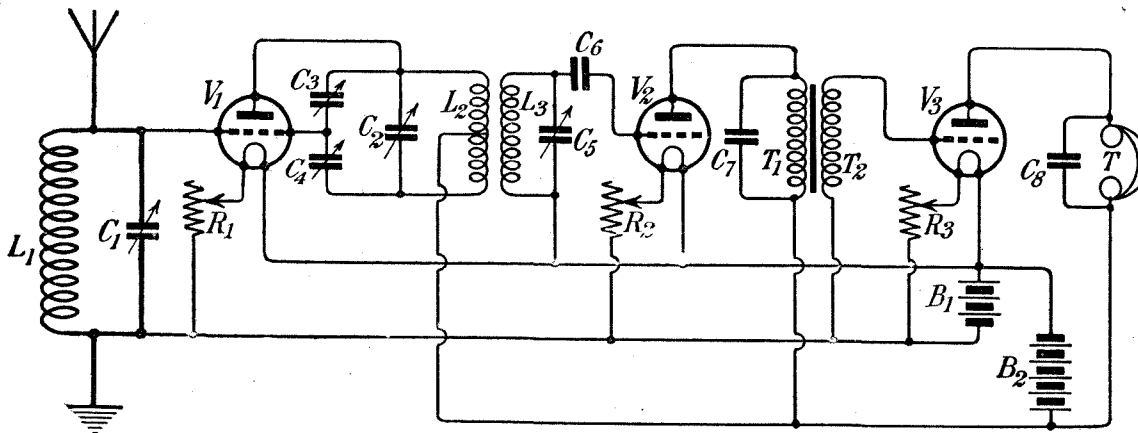

Fig. 1.—A comparatively simple form of Bridge receiver.

tend to oscillate to a certain extent. This tendency is due to undesired reaction effects caused by capacity coupling of one kind or another and to a certain extent by inductive effects. The capacity effects are produced principally through the coupling between the grid and anode circuits of the valves. The grid and anode forms a small condenser which effectively couples the two high-frequency circuits, and enables the transference of energy from the anode circuit to the grid circuit. This reaction effect frequently causes self-oscillation, and to prevent this it is necessary to introduce damping by some means or other; for example,

sufficient to transfer back enough high-frequency energy to produce a sufficient reaction effect to cause the circuit to oscillate.

The usual methods of overcoming this tendency to oscillate are inefficient in that they reduce the amplification very considerably. The usual methods merely stop oscillation by reducing the amplification effected by the valve. This seems to be a most undesirable method of stopping self-oscillation, as it is well known that a valve will oscillate even though its amplification factor is very small. In other words, the valve will often oscillate long before it has developed its full amplification powers. It is,

pany of America several years ago. Just recently the Neotrodyne circuit of L. A. Hazeltine has been made public. The writer's Bridge method, described below, is another attempt to solve the same problem. A patent application for this method was filed by the writer a long time before the Neotrodyne circuit was published.

In all these methods there is a common principle involved. The effect of the capacity coupling is neutralised, but whereas in previous arrangements a very critical adjustment has been necessary, in the Bridge method here described there is considerable latitude of adjustment, although the circuits, in

their present form, require considerable experimental knowledge and experience to work with success.

The principle, roughly, is that if an inductance is shunted by two condensers in series, and these condensers have equal capacities, there will be no potential difference at any time between the midway point between the condensers and the middle point on the inductance, no matter how heavy the current in the complete oscillation circuit may be.

This oscillation circuit in the Bridge amplification system is energised by the anode circuit of the valve, and the middle point between the condensers is connected to the grid of that valve, so that no matter how large the current in the anode oscillation circuit may be, no potentials will be communicated to the grid of the valve. In practice, one of the condensers, plus the capacity formed by the grid and anode of the valve, are balanced against the other condenser.

A Three-Valve Circuit

Fig. 1 shows a circuit of comparatively simple form which may be used to explain the principles and which may also be tried to gain experimental experience with the method. It will be seen that the first valve acts as a high-frequency amplifier, the second as a detector, and the third as a low-frequency amplifier. The anode oscillatory circuit of the valve is rather a complex one, and consists of the inductance L_2 , shunted by the variable condenser C_2 , and also by

two condensers C_3, C_4 , also variable, connected in series with each other but in parallel with the inductance. The condensers C_3 and C_4 , together with the condenser C_2 , might, of course, be replaced by a single condenser without altering the wavelength of the whole circuit.

The middle point on the inductance L_2 is connected to the positive terminal of the high-tension battery B_2 , while the middle point between the condensers C_3 and C_4 is connected to the grid of the first valve. The connection is taken to the right-hand side of the grid merely as a matter of convenience in drawing the circuit.

The inductance L_3 , which is shunted by the variable condenser C_5 , is coupled to the inductance L_2 in the anode circuit of the first valve. This grid circuit of the second valve is tuned to the incoming wavelength, and the coupling between L_3 and L_2 is preferably variable, thus providing a selective tuning system. The usual grid condenser and grid leak are connected in the grid circuit of the second valve. The anode circuit of the second valve contains the primary T_1 of the step-up interval transformer T_1, T_2 , the secondary T_2 being connected in the grid circuit of the third valve which acts as a low-frequency amplifier. This valve might, of course, be omitted, the telephones being connected in the anode circuit of the second valve.

Operation of the Circuit

It will be seen that only half of the inductance L_2 is included in

the direct current anode circuit. Nevertheless the whole circuit L_2, C_2, C_3, C_4 is energised by the oscillating currents passing through the top half of L_2 . The oscillation circuit is, therefore, excited by a form of auto-coupling. The grid G_1 is connected to the middle point between the two condensers C_3 and C_4 , and if these condensers have approximately equal capacities the grid G_1 will have the same potential as the middle point on the inductance L_2 , in so far as the grid is affected by any oscillatory current flowing the circuit L_2, C_2, C_3, C_4 .

Now the middle point of the inductance L_2 is connected to the positive terminal of the high-tension battery, the negative of which is connected to the filament of the first valve. From the high-frequency point of view, the potential of the middle point of L_2 is therefore the same as that of the filament of the first valve, so that we can now say that the grid G_1 will, in so far as it is affected by the oscillating currents in the anode circuit of the valve V_1 , have the same potential as the filament of V_1 . In other words, however heavy a current may be flowing in the anode circuit of the valve, by adjusting the capacities of C_3 and C_4 it is possible to prevent the anode circuit having any effect on the grid circuit. Theoretically, when the capacity coupling in the valve, combined with the capacity C_3 , equals the capacity C_4 , there should be no transference of energy from the anode circuit to the grid circuit; but in practice there are

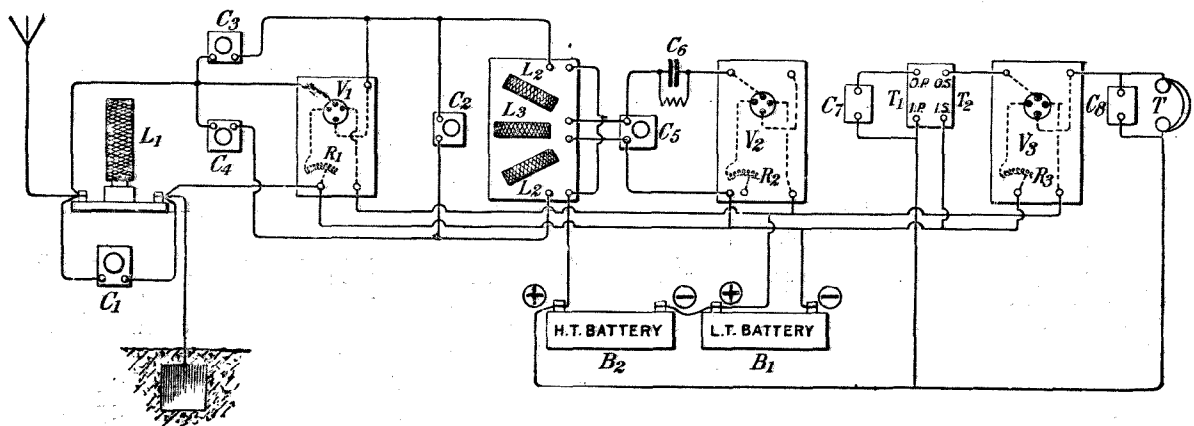

Fig. 2.—A pictorial representation of Figure 1.

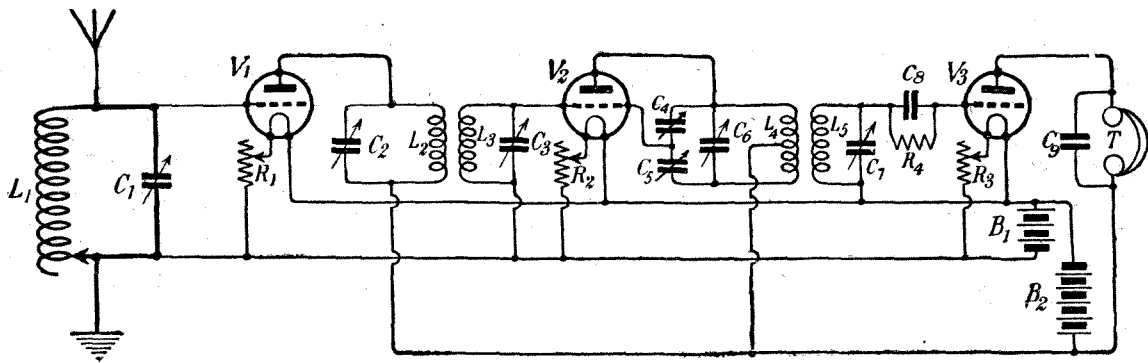

Fig. 3.—A three-valve set in which Bridge amplification is applied to the second valve.

various stray coupling effects, all of which may be neutralised by suitable adjustments of the condensers C_3 and C_4 .
The variable condenser C_2 enables us to readjust the tuning

circuit of the valve may be tuned entirely by means of the condensers C_3 and C_4 , the condenser C_1 being therefore eliminated. Before carrying out experiments with a view to minimising the number of controls,

using an inductance with the middle tapping, two separate equal inductances have been employed. These are the outside coils L_2 shown fitted to the coil holder in Fig. 2. In between these two

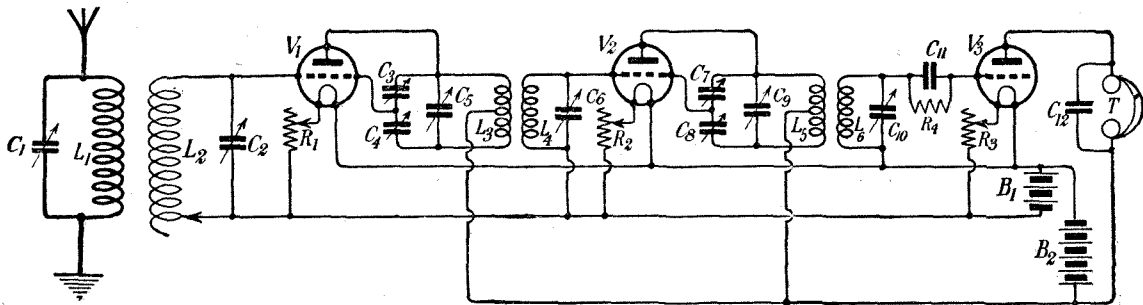

Fig. 4.—A circuit employing two stages of Bridge amplification.

of the circuit L_2 , C_2 , C_3 , C_4 , after C_3 and C_4 have been adjusted. The adjustment of the condensers C_3 and C_4 also necessitate a readjustment of the condenser C_1 . The writer has found that the grid

it is as well to gain experience with the circuit by using all the variable condensers shown.
Fig. 2 shows a pictorial representation of the circuit of Fig. 1. It will be seen that instead of

inductances there is the coil L_3 , which is tuned by the variable condenser C_5 , and which is connected across the grid and filament of the second valve.
In this circuit the inductance L_4

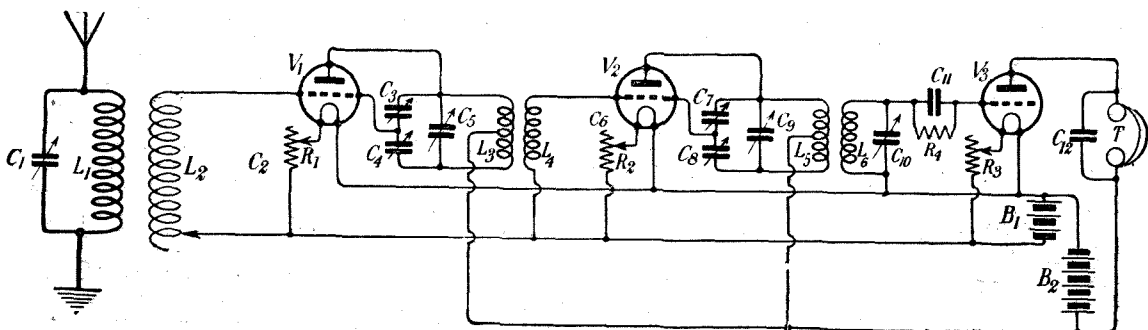

Fig. 5.—A simplified circuit in which grid condensers are eliminated.

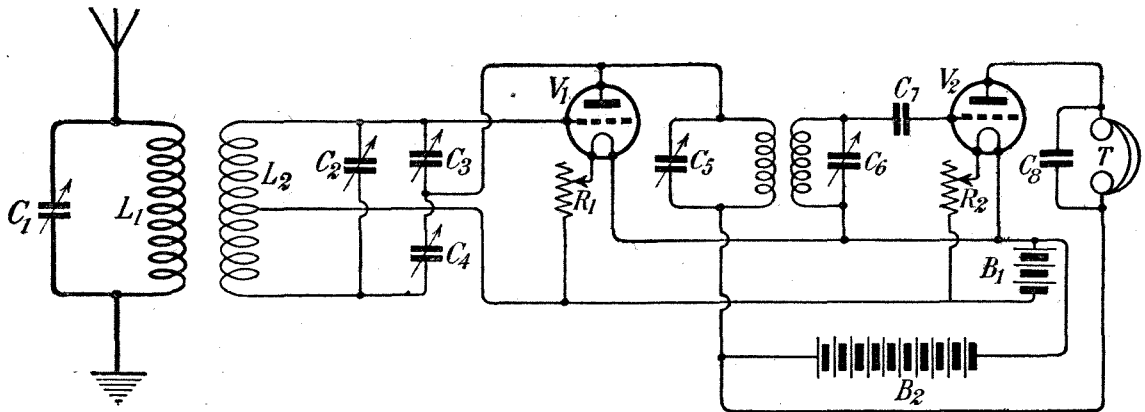

Fig. 6.—Showing method of using tapping on grid circuit inductance.

may be a Burndept S₃ coil, while L₂ coils are Burndept's S₁ coils connected in series. The coil L₃ is a Burndept S₄. All the variable condensers have a capacity of 0.001 μF.

Fig. 3 shows a three-valve circuit, in which the first two valves act as high-frequency amplifiers, and the third as a detector. The Bridge

respectively. Fig. 5 shows this simplified circuit in which the grid condensers are eliminated.

The Inverse Arrangement

Instead of forming the bridge in the manner previously described, it is possible to take a half-way tapping on the grid circuit inductance. Fig. 6 shows this arrange-

ment applied to a two-valve circuit. The anode circuit of the first valve and the grid circuit of the second valve are arranged as usual, but the connections to the filament of the first valve is made from the middle point on the inductance L₂. The grid circuit, as before, is chiefly tuned by means of the condenser C₂, but two variable condensers C₃ and C₄ are connected in the manner indicated.

Fig. 7 shows this alternative

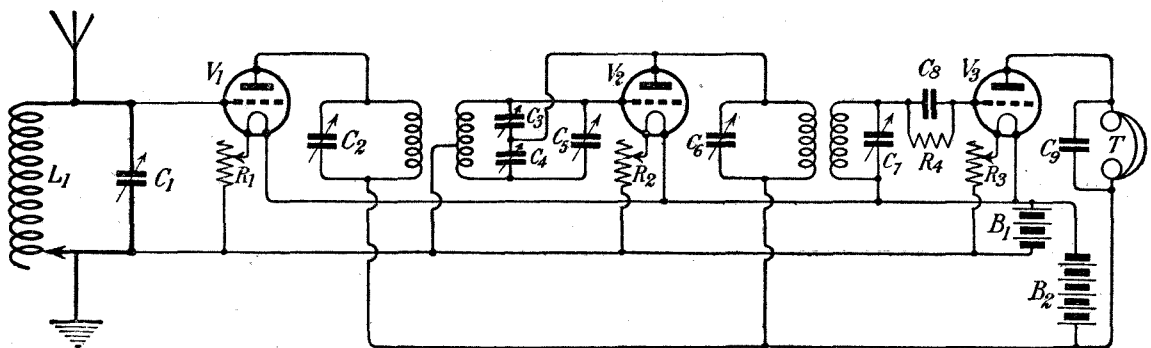

Fig. 7.—Inverse arrangement applied to a three-valve receiver.

method is applied to the second valve only, the first acting as a high-frequency amplifier in the usual manner.

Fig. 4 is an example of a circuit in which two stages of Bridge amplification are employed. A loose coupled arrangement is shown for transferring the aerial current to the grid circuit of the first valve. This arrangement is illustrated because self-oscillation of the first valve is more likely to occur when loose-coupling is employed.

Provided the inductances L₂ and L₄ have correct values, it is possible to tune the grid circuit of the first two valves by means of the condensers C₃, C₄, C₇ and C.

ment applied to a two-valve circuit. The anode circuit of the first valve and the grid circuit of the second

method applied to a three-valve circuit, the bridge being used in the second valve.

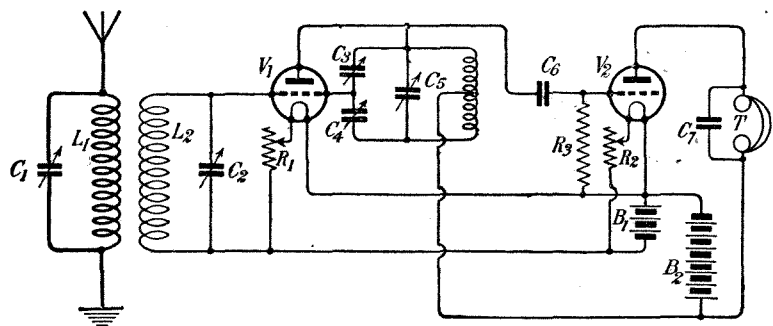

Fig. 8.—The Bridge method applied to a tuned anode receiver.

Application to the Tuned Anode Method of High-Frequency Amplification

Fig. 8 shows the application of the Bridge method of high-frequency amplification to a tuned anode amplifier circuit. This circuit possesses disadvantages from the point of view of signal strength, but otherwise it will be found perfectly stable.

Suggestions for Experiments

This method of amplification opens up a considerable field for

investigation. One of the balancing condensers, for example, might be fixed and the other only variable. A particular form of variable condenser, known as the three-electrode variable condenser, will be found to be particularly useful in this circuit.

The arrangement described will be found very selective, but experience is necessary in working them, in view of the number of adjustments. If separate variable condensers are provided for tuning the grid and anode circuits, the two balancing condensers might be so

arranged that their joint capacities will always be the same. The grid circuits may in some cases be made aperiodic in order to simplify the adjustments. Various other modifications will suggest themselves to the experimenter who proposes to carry out tests on this method of amplification.

We shall be very pleased indeed to hear from any experimenter who has obtained good results with this system, and we ourselves propose shortly to give full constructional details of a set operating in the manner described.

A NOTE ON THE CARE OF THE TELEPHONES

This article contains some very useful hints which should enable users of telephone receivers to obtain longer life and better service from the headsets.

IN the average amateur receiving station the telephones appear to come in for a great deal of neglect. The owner is generally satisfied if signals and telephony are reasonably loud, but, as is often the case, additional amplification is employed unnecessarily. The telephones may be at the root of weak reception, although the blame usually attaches itself to some other portion of the apparatus.

When purchasing a pair of telephones great care should be exercised. It does not necessarily follow that the most expensive will be the best, or that the cheaper variety are not efficient. The safest rule to follow is that something with a "name" is generally to be relied upon. When the two ends of a really sensitive pair are rubbed together a scratching sound will be heard in the receivers.

To those new to Wireless the difference between the two terms "high" and "low" resistance may not be understood. A high resistance pair, if not marked, can usually be distinguished by the earpieces being filled in with a hard, glue-like substance. The reason for this will be obvious later. For maximum efficiency the internal resistance of the phones (*i.e.*, the resistance of the pole windings), must equal that of the detector with which they are used. Whether the latter be crystal or valve it will be of the order of several thousand ohms, and it therefore follows that the phones must possess very high resistance also. Since they depend for their action upon "ampère-

turns" it is useless to use a few turns of high-resistance wire. In practice, many hundreds of turns of fine gauge wire are wound on the pole-pieces. It may be argued that many more turns could be put on before the required resistance would be reached, if thicker gauge wire were employed, but it must be remembered that the larger the wire the more bulky will be the receivers. This is, of course, an undesirable feature, as they must be essentially as small and light as possible to ensure comfort when worn for long periods.

In the case of high-resistance phones there is no disadvantage in connecting them directly in a crystal circuit, but it is a different matter when a valve is used as a detector. In this case a continuous current will be flowing through the windings and they may be subjected to potentials of between twenty and a hundred volts, or even more. The fine wire used has very thin insulation and is liable to break down, resulting in a continuous crackling noise being heard. In a very short while after this occurs the phones become utterly useless. The risk of shorts between adjacent turns and layers is to a certain extent minimised by pouring in some form of insulating substance such as shellac or paraffin wax and allowing it to cool. There is a possibility of burning them out through an accidental connection which subjects them to the full battery potential, and a certain risk of shocks to the wearer when certain parts of the apparatus be touched.

All these disadvantages can be overcome by using low-resistance phones and a telephone transformer. The transformer is merely an iron core over which is wound a primary and secondary. The high-resistance winding is connected in the place of high-resistance phones, to whose resistance that of the winding is equal. The low-resistance winding is joined in series with the low-resistance phones. Thus although the phones are of low resistance the rule of internal and external resistances being equal is still observed. The high-resistance winding can be of relatively thick, well insulated wire, since the size of the transformer is not such an important consideration. The windings of the phones themselves may also be more robust, the ampere-turns being made up by increased current strength. Not only will they be very much less liable to break down, but both phones and wearer will be entirely insulated from the rest of the apparatus. To a great extent the extremely irritating alteration of tuning which occurs when directly connected phones are used, and a movement is made by the operator, may be prevented.

A simply constructed transformer was described in the first issue of this magazine (page 69). When a transformer is used, instead of the received rectified impulses passing directly through the telephones they flow through the high-resistance winding, and as the current rises and falls so does a magnetic field which it creates. This field affects the low-resistance winding and induces a current in it, which rises and falls at the same rate as that in the detector circuit.

Telephones should never receive hard knocks, such as may be caused by dropping, etc., or

their sensitivity will be greatly reduced. The pole-pieces are permanently magnetised to a certain extent and a shock will destroy this magnetism. Some types have the diaphragm supported by a reed, with an adjusting screw at the back. This should be interfered with as little as possible, for it is an easy matter to "over-adjust" and break the reed.

When using phones in a valve circuit there is a right and a wrong way to connect them. While current in one direction will assist the magnetism of the poles, a reverse current will in time totally demagnetise them. This applies, of course, to directly connected phones. The ends should be marked. (This is done by the makers in some cases, but the majority are not marked at all.)

If at any time there is reason to suspect the telephones, their magnetism can be tested and if considerably weakened, the diaphragms will not stick. In some makes there is a small gap designed to protect the windings from any sudden high voltage impulses such as may be occasioned by lightning, induction from nearby transmitters, and accidental connection across the high tension. The points should be set as close as possible without touching, and examined periodically to see that no dust or moisture has caused them to be shorted. It is a good plan to have two pairs in use, changing them directly moisture begins to accumulate through wearing, and a bent or dented diaphragm should be immediately replaced.

Always remember that a pair of telephones requires as much careful handling as a valve. They are almost as delicate, and certainly more expensive when a replacement is needed. Every hard knock means a few more miles off their range.

Some of the

GOOD THINGS YOU HAVE MISSED

by not reading recent issues of WIRELESS WEEKLY.

A NEW FLEWELLING CIRCUIT—HOW I INVENTED THE THREE-ELECTRODE VALVE by *Dr. LEE DE FOREST*—OUT-DOOR EXPERIMENTS WITH RADIO by *PERCY W. HARRIS*—THREE-VALVE BROADCAST RECEIVER by *E. REDPATH*—SPECIAL ARTICLES ON VALVES by *JOHN SCOTT-TAGGART, F.Inst.P.*



Above & below the Broadcast Wavelengths

By LAMBDA.

The Importance of the Earth

NO small part of the falling off in signal strength about which most wireless men complain in summer time is due to the earth connection. The long hours of daylight, the prevalence of atmospheric and the screening of aerials by trees now in full leaf, have a great deal to do with the falling off that takes place in the quality of one's receptions, especially on short waves; but the condition of the earth is one of the most important factors. During the hot days the soil becomes parched, at first on the surface and then for some distance below. Dry ground has a very poor degree of conductivity, hence an earth contact that is left to look after itself may become the seat of a very high resistance. The early part of the present summer was very deceptive. We had a long period of grey sunless skies with quite a number of showers; one might therefore have thought that the soil was wet enough. Those who are gardening enthusiasts know that this was not the case. Very little rain actually fell, and what there was did not suffice to wet the ground properly, for high winds helped it to evaporate almost as soon as it had fallen.

The best way of making sure that the earth contact is good is to make a practice of giving it a bucketful of water once a week during the summer months. A most reliable earth can be made from a six foot length of old stove piping. A number of holes are punched in it and it is buried in an upright position so that the last foot of its length protrudes above the sur-

face of the ground. It is filled up for about half its length with riddled earth, the top three feet being left empty. If it is filled to the brim at regular intervals with water a good moist contact of very low resistance will be secured, for the water will leak away through the holes in the sides as well as through the bottom. It would be an improvement to make a pipe of either sheet zinc or galvanised iron rolled up, for these will not suffer so severely from the effects of corrosion.

And the Aerial

The aerial also requires attention. In winter the rain washes the insulators to some extent and keeps them fairly free from dirt. But if there is little rain, dust and soot settle on them; these attract moisture when the air is humid, and the sun bakes them into a hard cake. It is a good tip to lower the aerial every now and then and to give the insulators a thorough cleansing. For short-wave work two or three insulators should be used in series. Those of shell, ring or barrel types, even if they are perfectly clean, are responsible for losses by capacity. If we have the aerial wire separated from a supporting rope or wire by the material of the insulator, a condenser is formed with a dielectric of porcelain. By placing condensers in series we can reduce their total capacity to very small figures; hence the addition of two or three insulators at each end of the suspended wire may make all the difference between receiving and not receiving weak signals.

The Series-Parallel Switch

Every set should be provided with a series-parallel switch so that the A.T.C. and the tuning inductance may be used to the greatest advantage. In tuning we should always endeavour to use the largest amount of inductance, and the smallest of capacity possible. Short-wave coils have a much larger self-capacity in proportion to their inductance value than those wound for the lower frequencies.

When the A.T.C. is in parallel its capacity is added to that of the aerial and the inductance; when it is in series the total capacity in the circuit is reduced. Thus if we use a parallel condenser with a very small coil we have an undue ratio of capacity to inductance with consequent reduction of grid voltage. With the larger coils there is no such loss in efficiency, for even if the condenser is a big one the proportion between inductance and capacity never becomes unreasonable. The S-P switch enables one always to have the condenser in the right place. It also nearly doubles the range of one's A.T.I. coils.

American Amateurs?

There are few more fascinating pastimes than that of listening for amateur C.W. transmissions from the United States. The first successful experiments in picking up transatlantic low-powered signals were made last year, when a representative from America spent chilly nights near Ardrossan in listening for his compatriots. Using a very large set and an aerial far bigger than that allowed by the

P.M.G.'s regulations, he was able to report that he had received and identified about twenty-five of them. Further tests were carried out under the auspices of the Radio Relay League, and it was found that reception was possible with quite average sized sets using the normal amateur aerial. As a matter of fact when conditions are good, one can often hear a number of these amateurs with two stages of high-frequency amplification, and sometimes one will suffice to bring them in. The best time for

as ten shillings. Like baskets they are compact and easy to mount. Unlike them they have a very large self-capacity which makes them far from ideal to use. If you specialise on short-wave work, and tune in to the long waves very occasionally, then slabs may serve your purpose, for it is not worth while spending a good deal of money on inductances that will seldom be used. But the man who uses his set chiefly for work on the long waves will require something much more

turns are wound criss-cross so as to introduce an airspacing between them. The chief difference is that whereas in the basket only two turns go to a layer, the honeycomb and lattice coils may have a considerable number. It is possible to wind these coils by hand, but to do so is one of the most tedious and finicky jobs imaginable. The wise course is either to buy them ready made, or to invest in a coil-winding machine which enables them to be wound up for the cost of the wire.

Condensers

The question of variable tuning condensers is a most important one, for good condensers are the making or marring of a wireless set. On the short waves we want something which will give a smooth regular increase of capacity, and at the same time allow fine adjustments to be made. If the condenser is too small, the inductance in use will cover only a tiny band of wavelengths. If it is too large

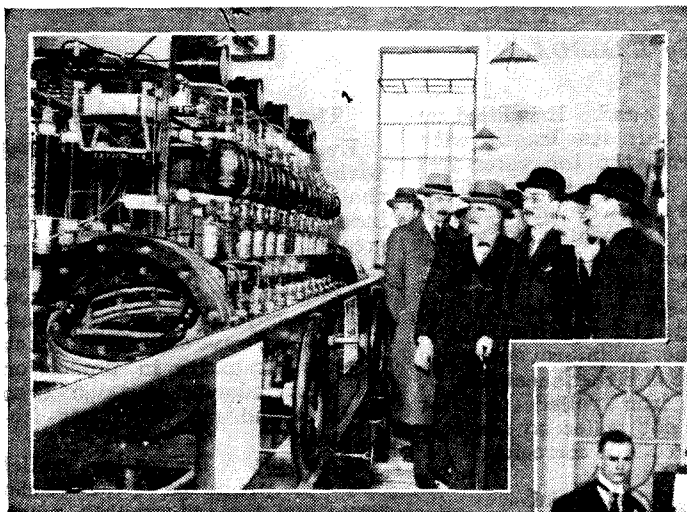

Members of Parliament inspecting the valve transmitter at Ongar.

them is between 2.30 and 3.30 in the morning, at which time Northolt and Leafield, whose "mush" when they are working blots out everything else on the short waves, are usually silent. It is best to use some form of local oscillator, but this is not absolutely necessary. Most of the American amateur stations have a characteristic note of their own due to their transmission methods, which is quite unmistakable once it has been heard.

Inductances for Long Waves

Owing to the proportions that it would need to assume if wound for wavelengths over, say, 3,000 metres the single slide inductance is out of the question for long wave reception. The same considerations bar out the telescoping loose-coupler and the basket coil. The cheapest inductances obtainable are the slab coils, a set of which covering wavelengths up to 25,000 metres can be bought for as little

efficient in order to obtain satisfactory results. He cannot do better than go in for honeycomb, or lattice-wound, coils, for though they occupy little more space than slabs, they are far more satisfactory to use in every way. The peculiar method of winding is specially designed to keep self-capacity at the lowest possible figure. The underlying idea is essentially the same as that which gave birth to the basket coil;

we shall miss many weak transmissions, owing to the huge difference in the number of cycles to which the circuit is tuned, made by the movement of its pointer through a single degree. On his short-wave set the writer has for some time used compact micadielectric condensers, whose spindle makes a movement through no less than 330 degrees between minimum and maximum capacity. The values found most satisfac-



The party at Radio House, watching an operator typing messages from undulator strip on which the messages are automatically recorded. Senator Marconi is seen standing on the extreme right.

tory are: A.T.C. (series) '001 μ .F., C.C.C. '0005, Reaction condenser '0005, Tuned-anode condenser '0003. These little condensers which occupy about a quarter of the depth needed by those of the ordinary air-dielectric type, are delightful to use. A great feature is that all contacts are positive. Those who have had experience of the rotary vaned condenser, with its brushing contacts with the moving plates, will know only too well what pranks it can play in its old age, when the spindle is becoming a little loose in its bush. If a rotary vane condenser has developed an uneven contact through wear and tear, the best cure is to remove the lower ebonite end piece temporarily, and to solder a small metal strip over the bottom of the bush. A drop of mercury can now be placed in the cup so formed, and when the condenser is re-assembled a good contact will be made. Care must be taken not to turn a condenser that has been so treated upside down.

For Long Waves

Condensers of the mica-dielectric type are excellently suited for long wave work as well. Here, of course, the A.T.C. will normally be in parallel with the A.T.I. As the addition of a given amount of capacity to a circuit makes a far smaller difference in the number of cycles to which it is tuned than is the case when one is working amongst the shorter waves, the closed circuit, reaction and tuned anode condensers may be larger, for tuning is as a rule not nearly so fine. If we come to a crowded band, such as that lying round about 12,000 metres, we can obtain selectivity best by using the loosest possible coupling, or by employing a local oscillator. It may be found a distinct advantage to be able to add at times a large amount of capacity to the circuit, in order to make one inductance cover a wide range of wavelengths. In this connection the following tip may be found useful. Provide each condenser with a second pair of terminals wired in parallel with its original ones, and have at hand a set of fixed condensers, whose capacities are equal to those of each variable condenser when at its maximum setting. By wiring up the fixed condensers to the

terminals mentioned, the capacity of each of the variables can be doubled at will. Thus if a transmission can just not be tuned in with the variable condenser at its maximum capacity the fixed condenser is connected, and the variable turned back to zero. A slight upward movement of the pointer should now enable the signals to be tuned in until they are at their best strength.

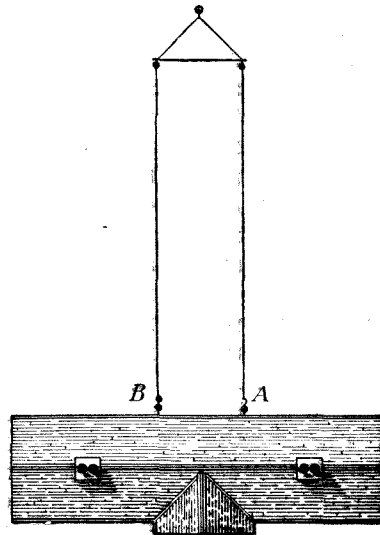

Fig. 2.

A Universal Aerial.

It is difficult to make the same aerial work satisfactorily for receiving both long and short wave transmissions. For the shorter waves, such as those used for broadcasting and by amateurs, it is highly undesirable to have too much capacity in the aerial; this is especially brought out when one is trying to tune down to the neighbourhood of 200 metres. On the other hand, for the reception of long wave Transatlantic messages, we need all the aerial capacity that we can get within reasonable limits if efficiency is to be obtained. The standard P.M.G. twin aerial containing 140 ft. of wire can be used with moderate results for the reception of transmissions of both types; but it is better so to construct the aerial that its capacity can be varied without great difficulty. The type shown in Fig. 2 will be found particularly useful. Here the mast supports a 6-ft. spreader to

which are attached two wires. The other ends of these are fixed each to a separate insulator. These can be fastened 6 ft. apart on a gable of the house, or they may be arranged on either side of a chimney-stack. Each wire has its own lead-in, the two coming in through separate tubes. For short waves only one wire is used. If longer wave transmissions are being received both leads-in are attached to the set. Care should be taken to see that the two wires and their respective leads-in are identical in length, otherwise each half of the aerial will differ slightly from the other as regards its natural frequency, which will make sharp tuning impossible when both are in use.

Short Wave Coils.

To obtain efficient short wave reception, we need inductances so designed that their self-capacity is at a minimum. There is nothing to beat the single-layer coil with sliders in this respect, but for valve work its lack of selectivity makes it unsuitable. The loose coupler, however, will be found an excellent piece of apparatus for the purpose. This instrument consists of two single-layer coils sliding one within the other. The outer should be used as the primary, the inner as the secondary, reaction, if used, being obtained by coupling the anode coil of the rectifying valve to the tuned plate inductance, or to one of the windings of a high frequency transformer. Basket coils are very largely used nowadays for short wave reception for many excellent reasons. They are cheap to buy, easy to mount, and compact in point of size. Their self-capacity, too, if they are made without an undue amount of shellac or paraffin wax, is low. Most of the types obtainable in the shops have, however, one great drawback. Wire of the same gauge is used for winding all sizes. This makes those wound for the shorter wavelengths so small that they are not very efficient, and owing to its thinness the wire used introduces into the circuits an amount of resistance that is far from desirable. The presence of a series resistance in a tuned circuit appreciably flattens the tuning, which is the last thing that we want when we are trying to separate transmissions on crowded wavelengths from one another.

THE MEASUREMENT OF SIGNAL STRENGTH.

Part II.—Amplification Ratios.

By A. D. COWPER, B.Sc. (Lond.), M.Sc., Staff Editor.

An interesting article on measuring the amplification of intervalve transformers.

IN the article on "The Measurement of Signal Strength" in No. 5 of MODERN WIRELESS, the writer showed how signal strength can be readily measured, without any elaborate apparatus, and with sufficient relative accuracy for most experimental purposes, by the method of "shunted phones." Although this has been known to, and practised by, professional radio-engineers for some time, as an alternative to much more elaborate methods, it appears to have been unknown to the majority of the new world of amateur experimenters.

Since the publication of this popular description of the method considerable interest has been displayed in the subject, and the following is an extension of the original article, with especial reference to the measurement of the ratios of actual amplification given by valve amplifying devices, and the testing of low-frequency intervalve transformers. This involves some consideration of the problem of the relation between "relative" and "absolute" intensity of audible

signals; and of the "threshold value" of sound in the observation-room, relative to which all measurements must necessarily be made.

Very erroneous estimates are sometimes made—often in all innocence—of the ratio of amplification obtained by particular devices, and some astounding errors have crept into recent popular literature (e.g., when giving the probable magnification obtainable by a multi-valve amplifier) as the result of accepting the casual evidence of the untrained senses when an amplifier is switched-in whilst receiving fairly uniform signals. An apparent immense increase of signal-strength will sometimes be observed with the first amplifying valve; less with the second; and perhaps little, if any, with the third, though signals will be "clearer" and less effort may be needed to read them continuously. Nevertheless, an estimate may be made of an amplification of anything from 5 to 10 times for the first valve; this then being assumed for the second and subsequent valves, in spite of the

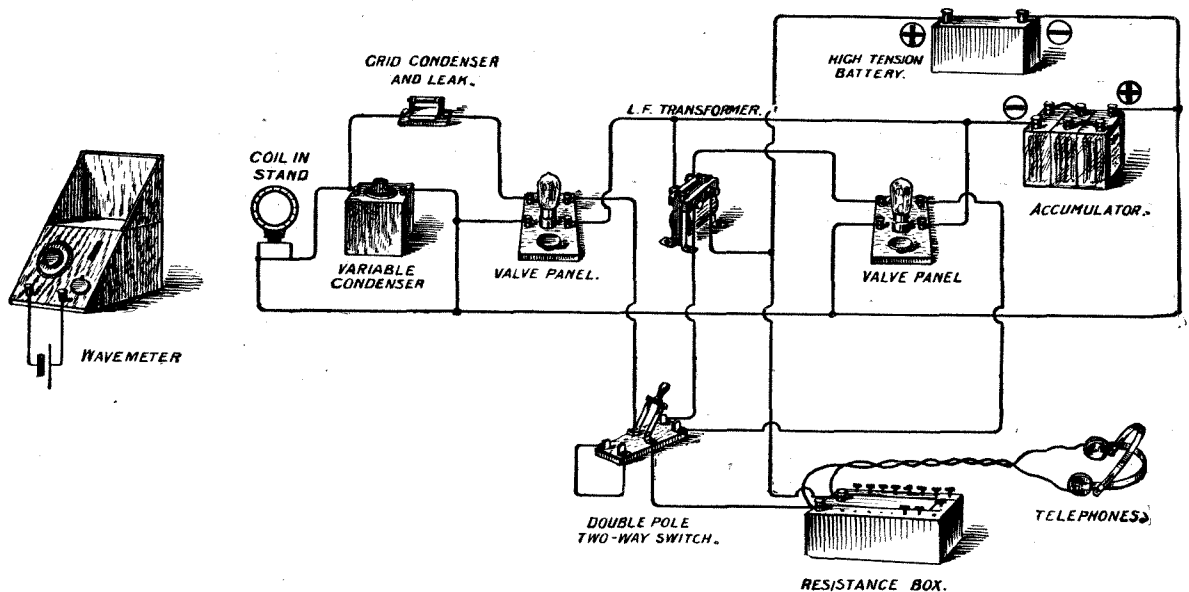

Fig. 1.—How the apparatus is arranged for testing the amplification of intervalve transformers.

evidence of the senses to the contrary. The statement has been solemnly made in a well-known American radio paper that an amplification of 100 times is obtainable with one valve, this giving a magnification of a million times with three valves!

If one could actually obtain an amplification of six or seven times the original *signal-strength* (not merely the theoretical voltage step-up deduced from the characteristic curve) with one valve, as is stated in some text-books, the merest whisper would be magnified to an overpowering loud-speaker roar by a three-valve amplifier, which is contrary to experience. Experienced professional operators will tell one that an amplification of 2 per valve is about as much as is reached in practice with many-valve amplifiers of stable design; while actual measurement of four stages (2 H.F., 2 L.F.) shows a magnification of 100 only, mostly in the last two L.F. stages.

The explanation of these wildly inaccurate estimates lies in this "threshold value" of sound, a factor which cannot be wholly avoided in the room where measurements are made, even if it be reducible to a minimum; and relative to which both the original and the amplified signals are estimated. (This incidentally gives a scientific explanation for the commonly observed fact that when friends are invited to listen signals are never more than one-third of the strength they were last night in the absence of those friends!)

The *apparent* signal-strength on an identical transmission with identical efficiency of reception can vary many hundred per cent. with alteration of this "threshold intensity." In an extreme case this is self-evident (for example: compare reception in a boiler-factory with that in a quiet cellar); but it is not sufficiently self-evident under more normal conditions because of that wonderful power of adaptation to different scales of average intensity of sound possessed by the human ear.

In order that signals may be definitely recognised, they must emerge from this welter of miscellaneous noises—their "absolute" intensity must exceed the threshold value

by an amount that is more or less a physiological constant for the particular observer, though it will vary somewhat according to his state of health and temper. With careful, patient observation this excess (absolute value over threshold value) can be reduced to a fairly constant minimum; a signal possessing an absolute value which gives this minimum audible excess is taken as of *unit strength* on the "shunted phones" scale. Evidently, then, this value of unit signal-strength depends largely on the actual value of the threshold intensity—the louder the average general noise in the room, the higher the absolute signal strength that will be clearly audible and will be named "unit strength."

Now when, after measuring the apparent signal strength, an amplifying device is switched in, and the resulting signal-strength measured by the method of "shunted phones," this enhanced signal-strength is reduced by

lowering the shunting resistance until only the minimum audible excess over the same threshold value is again reached: i.e., the signal is reduced to the same "absolute intensity" as that to which the original had

been reduced when measuring it. The signal-strength is calculated in each case from the formula $S = \frac{R + S_r}{S_r}$ (see No. 5 MODERN WIRELESS, p. 331): in reality as the number of times the total effective alternating current to which the signal gives rise exceeds the current through the phones for minimum audible sound. (*S* is the measured signal-strength, *R* the "impedance" in ohms of the phones, *S_r* is the shunt resistance which reduces the signals to minimum audible when connected across the phones.)

The ratio of the two signal-strengths thus measured gives a true measure of the actual amplification effected, independent of the fortuitous value of the threshold intensity at the time of the measurement, and of most other disturbing factors; though, of course, it is preferable to make the measurements in a quiet room, of low and *constant* threshold

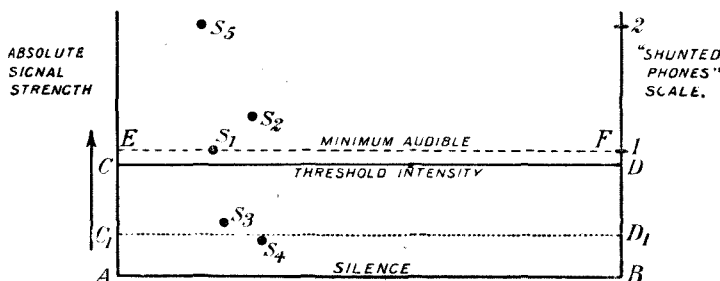

Fig. 2.—Showing the principle involved.

intensity of unavoidable noise. The principle is perhaps easier grasped from a diagram (Fig. 2) if the base-line AB expresses absolute silence, and if a line CD a short (and variable) distance above it expresses the average intensity of sound in the room (kept as small and as uniform as possible), then signals indicated by points S_1, S_2 , etc., will be just audible, being a little above the threshold value, while feebler signals S_3 and S_4 will be merged in the general noise, and inaudible. If S_1 is just sufficiently above the threshold to be sensible to the observer, i.e., is situated in the diagram on the line EF just above CD, it will have the value I on the scale of intensity. A signal S_5 , which is twice the absolute intensity of S_1 , will be cut down by shunted phones to the same intensity, which will evidently involve the shunting of half the effective current, and will give a measured intensity of two—though it will appear to casual observation to be so much clearer and easier to catch, emerging as it does so far above the general average of small noises of the environment, that one would be

tempted to say that it was at least four times as loud. Similarly, S_2 , although actually only 25 per cent. louder than S_1 , and shown so by actual measurement, may appear to be at least twice as loud.

Then if the average intensity of noise is very much decreased, to C_1D_1 (as for example by repeating the measurements in the quiet hours of night), S_3 becomes audible at strength about unity; and there appears to be very little difference between S_1 and S_2 at all, as they each emerge well above the threshold by amounts that are not very different!

It will easily be seen, then, how gross errors can be made in estimating relative signal-strength, and therefore amplifying power. For example, if signal S_1 be merely doubled by a valve amplifier to equal S_5 , it may

appear to casual observation either to have been multiplied ten times; or to be hardly altered in strength at all, but merely made clearer and more distinct—according as the threshold value varies. The ear rapidly and unconsciously adapts itself to the new, higher scale of sound, so that one notices only greater ease and freedom from casual interruption, rather than any increased intensity in the latter case. Accordingly, it is futile to attempt to estimate the amplifying power of, e.g., a L.F. transformer unit by guessing how many times louder the resulting signal-strength is after amplification: the actual signal-strength should be measured before amplification; and then, with as little delay and change in conditions as possible, the strength measured after amplification. The measurement of the original strength should then be repeated,

if possible, to make sure that conditions have not altered, and also repeated for several different intensities of the original signal. The mean of the ratios of signal-strength before and after amplification then gives a reliable figure for the effective amplifying power, inde-

pendent of the threshold value and other conditions of measurement.

A good way to get this mean value, and at the same time to check up the accuracy and uniformity of the measurements, is to plot the signal-strengths observed on squared paper (or in default of printed squared paper on a substitute made by ruling lines, say, $\frac{1}{4}$ in. apart on a sheet of plain paper, so as to make a lattice-work of squares), as in Fig. 3. The original signal-strengths S_1, S_2 , etc., are marked off at corresponding intervals from the origin O along the horizontal scale OP; and the amplified signal-strengths S_1, S_2 , etc., along the vertical scale OQ, which scale can conveniently be taken one-tenth as large. The points in the field corresponding to $S_1, S_1; S_2, S_2$, etc., are marked,

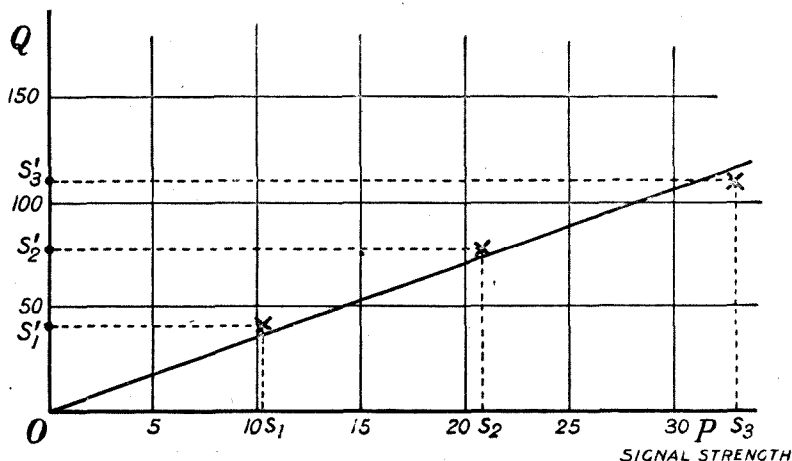

Fig. 3.—How to check the uniformity of measurement.

as shown, by an X; and the best straight line drawn from O to pass as near as possible to all of these points X. By putting the eye near O and looking along a faintly-drawn provisional line, this can easily be checked up. Then the slope of this line OXX (allowing for the different scales, horizontal and vertical) gives the best mean value for the amplifying power. In the diagram shown this is about 4:1.

Practically, the measurements take but little time when once the apparatus is set up. Some uniform transmission, adjustable as to intensity, is required. Broadcast Press bulletins and weather reports provide excellent material, being fairly uniform in intensity and available with certainty. By varying the

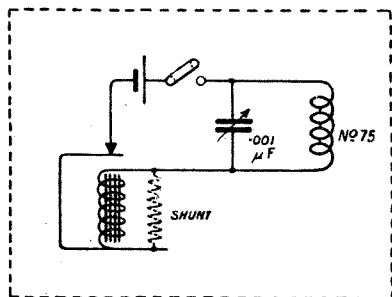

Fig. 5—Buzzer connections.

degree of coupling of a loose coupler, detuning slightly (this is a little dangerous), using different settings of an indifferent crystal, or other obvious devices, a range of unmagnified signal strength becomes available. A buzzer-wave meter, or tuned buzzer circuit, worked off a small accumulator for constancy, is perhaps best of all, as the intensity can be so readily altered by moving it to and from a tuned receiving circuit. The note should be high, clear, and constant—most of the cheaper types of buzzers have far too heavy and clumsy an armature for this purpose. The latter can be cut down with advantage by careful use of a hack-saw and file to a fraction of its original weight. The circuit is arranged as shown in Fig. 4, where the equipment

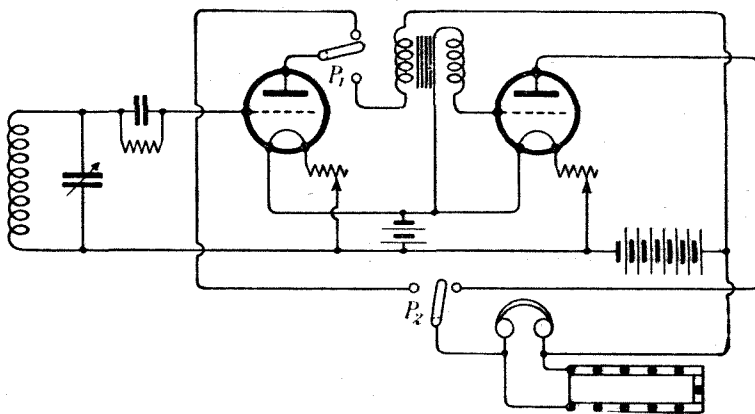

Fig. 4.—Connections for testing an intervalve transformer.

needed for measuring the actual amplifying power of a L.F. transformer is indicated. Uniform signals are picked up on the tuned circuit of the first valve, arranged as usual as a rectifier; while, by means of switches P_1 and P_2 , the phones (shunted by a box of resistances as explained in the first article in No. 5, pp. 331-332) can be put at will either in the plate-circuit of this valve or in the plate-circuit of the second valve; the L.F. transformer to be tested being connected up as usual between the valves. After adjusting the circuit for favourable operation, the signal strength is measured first with the phones in the plate-circuit of the first valve (while the second valve is alight, but disconnected); then, secondly (quickly, without altering anything else), with the phones following the second valve and with the transformer in operation; thirdly, with the phones once more after the

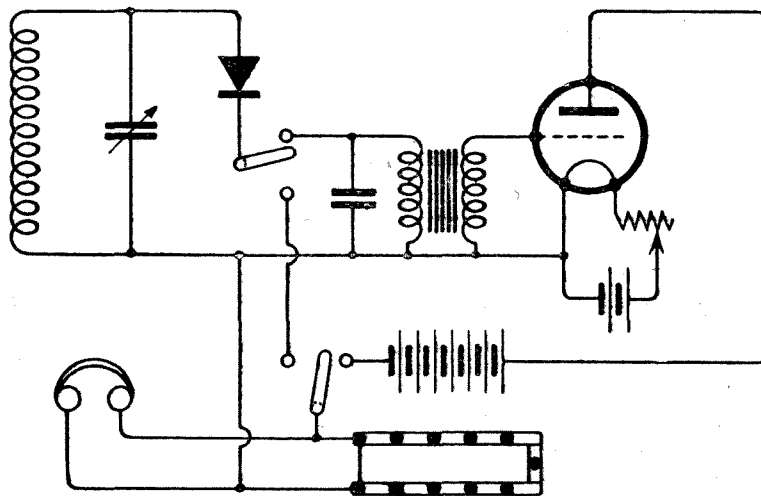

Fig. 6.—Testing a crystal-to-valve transformer

first valve alone. The first and third reading should be identical. The original signal strength is then altered by changing the reception conditions, or, if buzzer be used, by moving the latter to different distances, and the measurements repeated. The whole actually takes but a couple of minutes once the circuit is wired up. The switches P_1 and P_2 should, of course, have high insulation resistance and be positive in action; an ordinary double-pole two-way switch on porcelain or ebonite is very suitable. Especial care is necessary to ensure that the addition of the second valve does not materially alter the efficiency of rectification in the first valve, otherwise some very curious figures may be obtained. And from what has been said previously, it is evident that as uniformly quiet an environment as possible must be sought, and the measurements made rapidly and not immediately after the ears have been deafened by loud signals.

If not at hand, the tuned buzzer circuit can be made up conveniently from an ordinary buzzer, or a small electric bell cut down, with the armature lightened as suggested, and the magnet-windings preferably shunted by a short piece of resistance wire (of 10 ohms or more). A spider or basket-coil of about 75 turns, or corresponding honeycomb-coil, with

a variable condenser of .001 μ F across it; a small 2-volt accumulator (a dry cell soon runs down on this work) and some kind of switch complete the circuit. The whole is best mounted on a board or in a box with the coil vertical, the buzzer being silenced as much as possible by felt covers; such a source of tuned constant transmission is invaluable in experiments involving measurements of signal strength. The tuned grid circuit on which the signals are picked up can consist of the ordinary

secondary coil of a loose-coupler, or a coil similar to that in the buzzer unit, and arranged a foot or so away from the latter.

Obviously, the same arrangement is available for testing crystal-to-valve L.F. transformers, as shown in Fig. 5. Fig. 7 shows the connections for comparing

the performance of two L.F. transformers, and is self-explanatory.

Note.—In a subsequent article methods for measuring the relative efficiency of tuning devices, different intervalve couplings (other than L.F. transformers) of rectifying valves and crystals, etc., will be explained; and any difficulties will be dealt with that readers of these articles have met with in adapting the method to their own use, and which they have been so good as to communicate by letter to the Editorial Department.

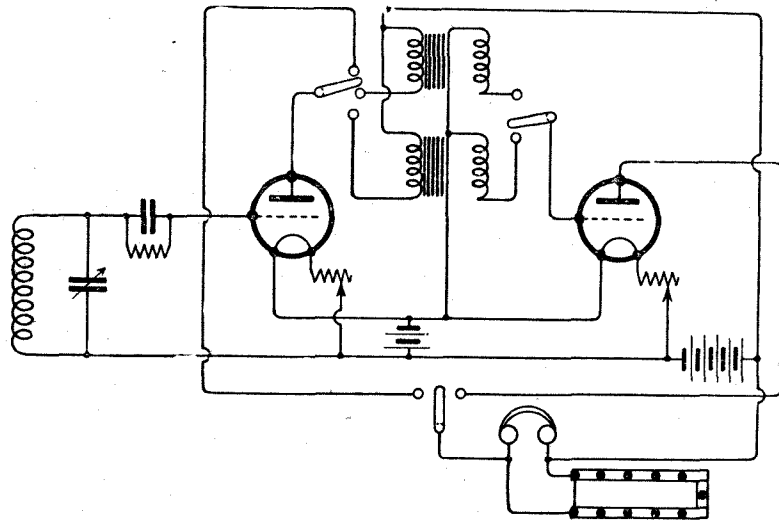

Fig. 7.—Circuit arranged to compare two transformers.

A RESIGNATION.

The following letter has been received by the Secretary of the Radio Society of Great Britain from Mr. John Scott-Taggart, Editor of "Wireless Weekly" and "Modern Wireless":

Dear Sir,

I have felt for a considerable time that my position on the Committee of the Radio Society of Great Britain is an embarrassing one, in view of the desirability of editorial independence, and the great difficulty I have in reconciling my editorial work with an active association with policies which may, at times, call for independent criticism.

My presence on the actual committee might give rise to misunderstandings, and I therefore trust that you will accept my resignation from it.

I am, of course, proposing to remain a member of the Society, and intend to further its real interests, both personally and through the medium of my journals.

Yours truly,
(Signed) JOHN SCOTT-TAGGART.



Spark Interference.

To the Editor MODERN WIRELESS.

SIR,—Several points raised in the Editorial of the June issue of MODERN WIRELESS arouse my interest with particular reference to interference. I would therefore like to mention my experiences in this hotbed of spark interference as they tend to confirm the Editor's suggestions.

Even a coupled circuit in this district affords no real relief from incessant jamming as we are so close to the source of trouble. My wavemeter also discloses that not a few transmitters are badly adjusted. Quite frequently, nominal 300 metre stations are found to be very wide of the mark and curiously enough they usually manage to work on 350 metres when they are not correctly tuned. Consequently reception from Cardiff or London is impossible while these ship stations are working, and if Newcastle and Birmingham are tuned to for relief the 450 metre stations then play havoc.

I have succeeded in making my receiver sufficiently selective to cut out 600 metre stations even with a direct coupled A.T.1; so much so, in fact, that for months I have not heard a 600 metre station when my receiver has been tuned to 450 metres or less. But I notice that GNI has a harmonic around 450 metres (not very strong), which I can cut out without much difficulty. In other words, I think 300 metre and 450 metre stations are responsible for most interference on broadcasting wavelengths.

My wife and I have been so disgusted with the jamming that we have given up the loud speaker

for telephones because it is most noticeable that with only two valves (1HF and 1Detr), all the broadcasting stations are heard quite clearly, and practically no jamming is noticed until a third valve is switched in. I find that a stage of low frequency amplification counteracts the selectivity obtained from one stage of H.F.; its effect is so bad that my own private rule is:—Never use the stage of L.F. unless two stages of H.F. are employed; or use three stages of H.F. before two of note magnification. Although this is not *completely* successful, it is decidedly better than making a terrific noise with an unwanted accompaniment, and I would suggest to all those troubled by spark jamming that it is worth while trying reception with the note magnifier cut out, and if they wish to use a loud speaker they must either put up with the jamming or add more H.F. valves.

I have found that serious interference can usually be cut out by extremely loose coupling without too great a loss in signal strength. My transmitter is situated about 18 in. from my receiver, and during the old days of concerts from Writtle (2MT) I found I could completely cut jamming by tuning the transmitter to the wavelength required (all switched off, of course) on the aerial, and merely use the A.T.1 of the receiver as a secondary circuit. Looser coupling made very little difference, but any attempt to couple the two circuits more closely not only brought in interference again, but lessened signal strength. This effect is by no means new (Mr. Reeves read a paper on the subject before the

Radio Society of Great Britain a long time ago), but it does not appear to be extensively used; except that some people have recently regarded it in the light of freak reception on account of certain results they have obtained. I do not think it is the case.

Yours, etc.,

E. J. HOBBS (Capt.).

Wareham, Dorset.

Dual Amplification:

To the Editor of MODERN WIRELESS.

SIR,—First of all I congratulate you on the production of two perfect Wireless Journals, in which you have so simplified Wireless that no one should have the slightest fear in starting to construct their own Wireless receivers.

In No. 7 of the *Wireless Weekly* there was a description of a super sensitive crystal valve set giving dual amplification. Having converted a low frequency unit into that set, I was very surprised to find that I got far better results with the crystal removed out of circuit altogether; perhaps some kind reader will tell me the reason.

Then came along the ST100. After studying over the circuits I realised that with very few alterations the LF panel would be just the thing, so with the addition of a 50,000 ohm resistance, and the alteration of just two connections of another LF unit, the set was complete.

With a galena crystal I started the test out on a wavelength of 17,000 metres, but there was nothing doing. I then tried a Perikon, and immediately picked up several well-known stations, gradually lowering the wave length and

improving all the time, until at last I arrived at 5IT, when I was agreeably surprised at the strength and clarity of speech and was quite convinced that the circuit was all you represented it to be. This was on the first reception, which I have no doubt can be improved in many ways. The filament voltage was rather high before I got real silent, perfect reception. I hope some reader will enlighten me on that one point.

ALFRED FRANCE.

Rotherham.

The ST100.

To the Editor of MODERN WIRELESS.

SIR,—I was very struck with your ST100 circuit and note you are asking for results.

I mounted and wired up this circuit on a panel 10½ in. by 11½ in. and completed it before testing. I must say I was amazed with the results. I used polar condensers, Formo transformers M.O. "R" valves (I found these answered better than LS2, Ora, Ediswan or Cossors). The set worked on Ampion loud speaker very clearly and of pleasant volume. On an outdoor aerial (38 miles from London), it appears to nearly double the volume by increasing plate voltage from 42 to 100 volts. I found no interruption on another aerial 40 yards away and running parallel. Speech, etc., was absolutely free from distortion. Hertzite answered better than Rectarite. I am looking forward to further circuits of similar character in MODERN WIRELESS or WIRELESS WEEKLY.—Yours, etc.

DESBOROUGH DOBSON.

Cuckfield, Sussex.

Valve and Crystal.

To the Editor of MODERN WIRELESS.

DEAR SIR,—With reference to the valve and crystal set referred to in your excellent paper MODERN WIRELESS, I have pleasure in stating that although I am a beginner in Wireless I have succeeded in making this set. The results obtained are highly satisfactory. I am living in the South side of Glasgow and with about 30 ft. of aerial wire suspended from my third floor window. I can get both 5NO and 2ZY. Glasgow comes through on a loud speaker, and I can also get ships' stations quite

well. Thanking you for your valuable assistance and wishing MODERN WIRELESS every success.

I am, yours, etc.,

KENNETH THOMAS TRIGGS.

Cathcart, Glasgow.

More Dual Amplification.

To the Editor of MODERN WIRELESS.

DEAR SIR,—Adverting to Mr. Dormer's article in the June MODERN WIRELESS, may I venture to offer you the result of my own experiences. I became interested in Dual Amplification owing to Mr Voigt's original article in No. 1 of MODERN WIRELESS, and since he has written other articles on the subject in the radio press. After

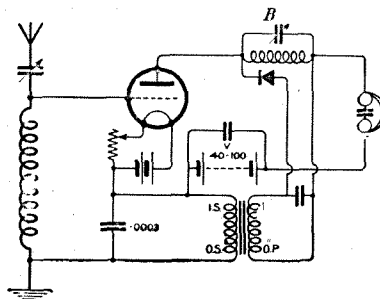

Mr. Fowler's circuit.

trying various circuits I find that I get my best results both for LF amplification and distance by the circuit indicated herewith.

I felt after reading Mr. Dormer's letter that the circuit was worth passing on, although doubtless many of your readers have developed a similar circuit.

May I express my best wishes for the continued success of your paper, which is proving its claim to be

better than the best among wireless periodicals.

Yours faithfully,

(sd.) T. E. FOWLER.

Hanwell.

Editor's Note.—The circuit shown above is practically the same as that used by Mr. G. P. Kendall, B.Sc., in his article in last month's M.W.

A Novel Loud Speaker.

To the Editor of MODERN WIRELESS.

DEAR SIR,—I have been successful in building and working the S.T.100 circuit, and a simple loud speaker, which was made for the occasion and which proved highly satisfactory, may be of interest to the readers of MODERN WIRELESS. It consists of an ordinary commercial pudding basin 10½ in. diam. and 4½ in. deep, a small trumpet made out of a piece of tin and a small piece of ⅜ in. diam. brass tube, a brass disc 2½ in. diam. by ⅛ in. thick, 12 in. of ⅜ in. brass rod, sundry nuts and washers to suit rods, two pieces of wood 12 in. by 1¾ in. by ½ in. and an ordinary telephone ear-piece.

The arrangement took 3 hours to make at a total cost of 1s. 6d. for material, plus the earpiece, which was a war surplus one and cost 2s. 6d.

Several friends who have listened in prefer the quality of tone given, by this speaker to any commercial made speaker they have heard.

Yours truly,

(sd.) W. H. CARROLL.

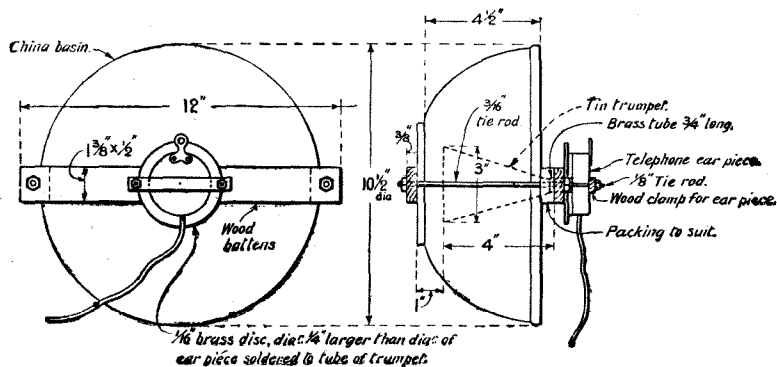

A novel loud speaker.

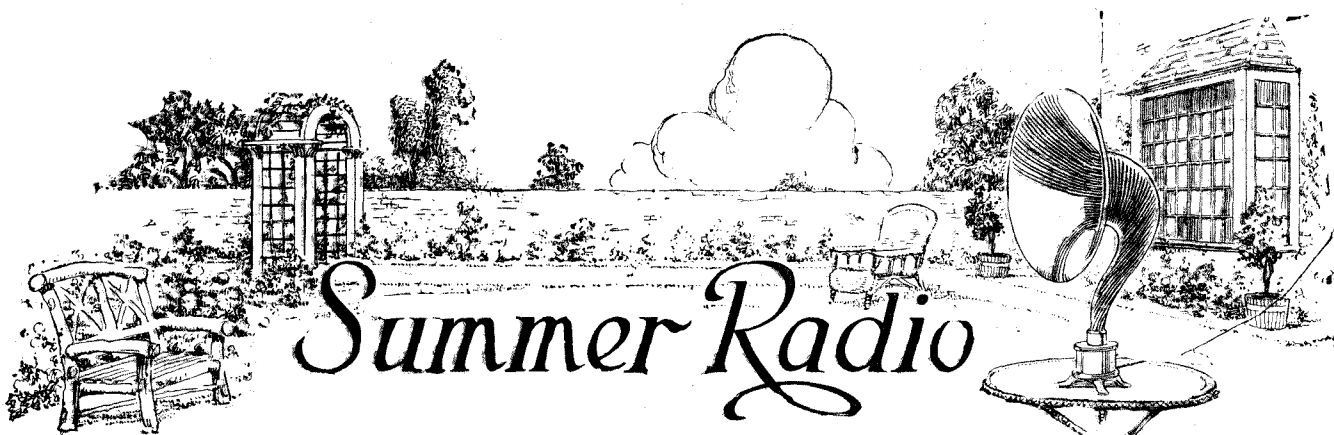

The Call of the Open

There must be a time when the experimenter will emerge from his den, when he will make his last reception a good enough standard for appreciating the joys of even a broadcast concert, when he will feel that there is much to be said for wireless in the open air.

The enthusiasts of wireless are as likely to overlook its promise as the tyros. The former find themselves far too engrossed in experiment to bother to take the set out of doors, or even further afield to the river, while to the latter it presents untold difficulties.

But the fact remains that the receptions in the open air are generally remarkably good, and there is also the added pleasure of keeping one's wireless hand in, so to speak, while on holiday, and add to the pleasures of the holiday by being able to listen in when and where one pleases.

Riverside Wireless

Riverside wireless this year in the London area started long before summer came, but observations by the writer in the area around Birmingham, in all the week-end retreats, have given little cause to suggest that summertime wireless is anything more than an idea in the Midlands.

Why it is difficult to say. In all other ways the interest in wireless is very strong indeed, and from end to end of Birmingham itself there is a sufficient multitude of wireless folk to suggest that if summer wireless delights were at all realised they would be very widely indulged in.

On The Avon

A proof was provided by the first wireless river party which took place on the Avon just

above Stratford on July 7, when a little party, provided with a Marconi 2-valve set and two stage amplifiers and two loud-speakers, and using an aerial slung from an adjacent tree to a punt pole set in the bed of the river, picked up Birmingham and London and the other stations, and drew, even from the charms of the gramophone, an interested audience of river people.

The Wireless Atmosphere

It is somewhat strange that though a great deal of attention and discussion has concerned the atmosphere of the broadcast studio, no one has as yet suggested that there is also an ideal atmosphere for most successful listening-in—apart from the consideration of the technical detail of a working receiver. For perfect enjoyment of wireless broadcasts there is needed something more than a set working well and a pair of head-phones to the ears or a perfect loud-speaker.

There is the comparatively unconsidered importance of surroundings—lack of high lights, a prevalence of shadows—those tricks of furnishing and decoration which make the perfect house. Now, since all art is in a sense an imitation of nature, it is not surprising that at times a certain marvellous appropriateness is found in moments of listening-in in the open air. There seemed this sense in the particular river concert referred to above; and though the spot was hastily picked, and though there was little preparation, the transmissions picked up from Birmingham and London were remarkable clear, were striking in their comparative freedom from local interferences, and in certain items contained an elfin quality of suitability, blending, harmonising with this setting that nature had provided.

A Car Set

The experience of the initiators of river wireless on this particular occasion also included a signal feature. The "junk" had been carried in a car which represented the latest application of wireless to a motor-car. A 30 h.p. 1923 Daimler landaulette de luxe, utilising a plate as the roof aerial, had been fitted with an 8-valve Marconi special car set, controlled by a panel concealed in the upholstery of the interior.

Given a range of 60 miles, Birmingham was tuned in on the road between Birmingham and Stratford-on-Avon, and then in Stratford itself, moving through the streets of the Immortal Bard's birth town, the Birmingham broadcasts were heard. The occasion became particularly memorable when a halt was made outside Shakespeare's birthplace, and in the shadow of this historic building a super-modern installation of wireless apparatus permitted the radio voice of Birmingham and even London to be heard and understood. The thought sprang out of the realisation of the progress that has come with time. What of this latest marvel would Shakespeare have thought?

The photographs show a pleasant outing on the Avon with the help of a Marconiphone.



Above: Placing the earth net in the river while the aerial is being tied to a punt pole.



Below: Listening to the Birmingham station on the Avon at Stratford.

LIGHTNING AND WIRELESS.

The recent terrific thunderstorm experienced in the London area and in other parts of the country made many wireless beginners fearful as to their safety. There has been much talk about wireless aerials and lightning, and some people have feared that in the case of a thunderstorm there would be a big danger of their own

installation being struck. The idea is certainly plausible, but how does it measure up to actual facts? So far we have yet to hear of a single receiving aerial damaged by lightning in this country, whilst in the United States, where wireless aerials are far more numerous than here, the danger is reckoned to be negligible.

"DIRECTIONAL WIRELESS"

By J. ROBINSON, M.B.E., Ph.D., M.Sc., F.Inst.P.

(Continued from p. 445.)

In this article Dr. Robinson concludes his description of direction-finding work and deals with some possible explanations of why night variations occur.

THE determination of the direction of wireless waves has generally been based on the assumption that the origin of the waves is on or near the surface of the earth. Also, as transmission usually takes place from elevated aerials, it has come to be generally accepted that the electric force is usually vertical and the magnetic force usually horizontal. On these assumptions the typical direction-finding system has been a single loop in a vertical plane capable of rotation about an axis in its plane. The ultimate object of a direction finder is to find the actual direction of propagation of the waves; and it has been shown that the electric force, magnetic force, and direction of propagation are all mutually at right angles. On the assumption that E is vertical and H horizontal, the ordinary direction-finder will give accurate determinations of the direction of propagation. It is, however, possible that these conditions may not be obtained, and that both E and H may be oblique to the surface of the earth, and thus the direction of propagation may not be parallel to this surface. Another case may arise in which waves may arrive simultaneously at a receiving station in two or more different directions from the same transmitting station. With these possibilities, and from the fact that under certain circumstances errors in direction-finding are observed with present-day apparatus, it is essential to consider, in the first place, what is actually determined by a single loop; secondly, what is the effect on the observed direction if the waves are tilted, and, again, what is the effect of waves from the same transmitter arriving in two or more directions at the receiving station.

What a Simple Loop Actually Determines.

In endeavouring to discover what a simple loop actually determines about the direction of propagation of waves, it is to be understood that this loop is used merely as a typical example of almost all present-day direction-finding systems. Earlier in this series of

articles (see Fig. 3) (*Modern Wireless*, No. 2, Vol. I.) the theory of reception of electromagnetic waves by a simple loop was developed. This theory was developed from the ordinary laws of electromagnetic induction by considering the amount of variation in intensity of the magnetic field which passes through the plane of the loop as the wave passes. It was seen that the electromotive force was zero when the magnetic force was parallel to the plane of the loop. Present-day loops are rotated about a vertical axis. When the zero is determined it is known that the magnetic force is parallel to the plane of this loop. This is an important fact, and it is the only statement that we can make with certainty.

The assumption is usually made that the magnetic force is horizontal, but it would not matter to the loop what direction this magnetic force has in the plane of the loop, that is, the magnetic force may be vertical or horizontal or any direction in the angle included between those two, and the electromotive force will be zero so long as the magnetic force is parallel to the plane of the loop. By making the assumption that the magnetic force is horizontal and that the electromotive force is vertical, the deduction can be drawn that the direction of propagation is perpendicular to the plane of the loop when there is zero electromotive force in the loop.

These assumptions may not be correct, however, and there may be cases where H is not horizontal, and in order that the loop can still be used to determine the direction of H it will be necessary to make the axes of rotation of the loop more general, *i.e.*, it should be capable of rotation about other axes than the vertical. Suppose that the loop is capable of rotating about a vertical axis and also about a horizontal axis, this can be done by an arrangement similar to gimbals as illustrated in Fig. 25. We will refer to this as a universal loop. Suppose that the loop has been rotated

about its vertical axis to determine a zero, it can be determined then whether the magnetic force is horizontal by rotating the loop about a horizontal axis. If H is horizontal, then rotating about a horizontal axis will mean that H is always parallel to the plane of the loop, and there will thus be a permanent zero. However, if H is not horizontal, rotation about this horizontal axis will mean that H will not always be parallel to the plane of the loop and an electromotive force will be obtained. Thus in order to determine H it is necessary to have a universal loop and to rotate it about the various axes until an axis of rotation is obtained which will give a permanent zero. When this is obtained it is known that H is parallel to that axis of rotation. *We thus see that all that a universal loop determines is the direction of the magnetic force.*

Another way in which H can be determined instead of using a universal loop is to use three identical loops at right angles to each other, preferably one horizontal and the other two vertical, and to measure simultaneously the intensities of signals heard in each loop. From the relative intensities in the three loops the direction of H can be obtained. This is not so simple, as in order to obtain a complete determination it will be essential to take into account the phases of the currents induced in the loops. As far as is known this method has not up to the present been employed.

A loop rotating about a vertical axis merely determines the vertical plane which contains the magnetic force. When using this specialised loop and when a zero has been determined, it means that H is in the vertical plane of the loop. The direction of the electric force may also be in this plane. In this case if both E and H are in the vertical plane, then the deduction of the direction of propagation as being perpendicular to the plane of the loop for zero effect is correct. However, if E is not contained in the same vertical plane as H our deduction of direction is in error.

It is known that waves are obtained which have not the magnetic force horizontal and the electric force vertical, and whose direction is thus not parallel to the surface of the earth.

An obvious example of this is in transmission from an aeroplane which is above the surface of the earth. In this case the direction of propagation cannot be parallel to the surface of the earth unless the distance from the aeroplane is very great. Hence, to determine accurate directions of an aeroplane in flight it is essential to bear in mind the principles which have just been described. Another case where the direction of propagation may not be along the surface of the earth is from atmospherics. The source of atmospherics is often at a great distance above the surface of the earth, and here, again, in order to determine accurate direction it is essential to bear these principles in mind. Other cases may arise, such as where the waves travel over mountainous country; and it is easy to appreciate how in these cases the direction of the electric and magnetic forces can be twisted from their normal directions.

Again, where waves have to travel over metallic deposits it is quite possible that the directions of both H and E are influenced. It thus appears somewhat remarkable that accurate direction-finding has been possible, seeing that the apparatus used has involved so many assumptions. *The fact that direction-finding is usually so good shows that the assumptions made—that the electric force is vertical and the magnetic force horizontal—are, in general, well founded.*

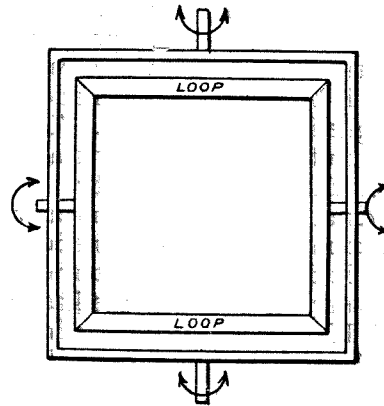

Fig 25.—A loop aerial arranged to rotate in gimbals.

The Absolute Determination of Direction.

Having seen that all that a loop determines is the direction of H, in order to determine direction absolutely it becomes necessary to determine also the direction of the electric force. This is possible by the use of plane aerials which are capable of rotation in a similar manner to that of loops. It is advisable in this case to use Hertzian oscillators with the receiving apparatus in the centre and capable of rotation about a universal axis, such a system giving a maximum effect when the aerial is parallel to the direction of the electric force. This type of aerial is, however, not very suitable for long waves, as it is necessary to keep the aerials very short for manipulation purposes and it is essential to use large loading coils for tuning, and these loading coils act

somewhat as loops and tend to pick up radiation directly and so upset observations.

Waves Arriving in Two Directions from the Same Source.

In using a simple loop it was shown that only the magnetic force is determined. In the case of waves arriving in two different directions it is impossible by means of loops to separate the components. In order to see the effect on a loop of waves arriving in this manner it is advisable to simplify matters as much as possible and to concentrate only on the magnetic force.

Consider what happens if the two magnetic forces are both in the horizontal plane. If the phases are identical, there is a resultant magnetic force the plane of which will be indicated by a simple loop, but this direction is wrong, as neither H is determined, and, moreover, even if we could separate individual magnetic forces it would be impossible to decide on which is the correct one. What is more likely to happen, however, is that the phases are different. Now this will mean that with a vertical loop there will never be a zero at all except in the special case where both magnetic forces are along the same direction, although there may be a minimum, and in this case one would have to determine the minimum instead of the zero. The fact that no zero was obtained would indicate to an experienced operator that the direction of propagation indicated by the loop should be treated with a certain degree of suspicion.

In the case where both the magnetic forces are not in the horizontal plane, although one of them may be, the case is still more complicated. Thus, considering the question of magnetic forces alone, we find that the simple loop tells us very little about the directions of the two waves, and with a loop it is impossible to separate them. When one in addition attempts to consider the actual direction, it can be appreciated how complicated the problem becomes. A special case is worth noting where the two components may be of equal magnitude at right-angles to each other and at 90° phase difference. In this case the intensity is uniform, and on rotating the loop no variation in signal strength can be detected. The problem therefore appears to be incapable of solution.

Attempts have been made on various assumptions to try to obtain accurate bearings under

the foregoing conditions. One suggestion was made by Eckersley that any reflected wave would have the electric component horizontal and he attempted by means of a horizontal coil to balance out this component. Again Adcock used a system of Bellini-Tosi aerials where the top horizontal portion was omitted and the bottom horizontal limbs were arranged to balance out against each other. This method seems good in theory, but it introduces many difficulties in practice.

As to how these variations may arise, a hypothesis of the Heaviside layer has been introduced. This layer is at a height of about 50 to 100 miles, and any wave incident on it

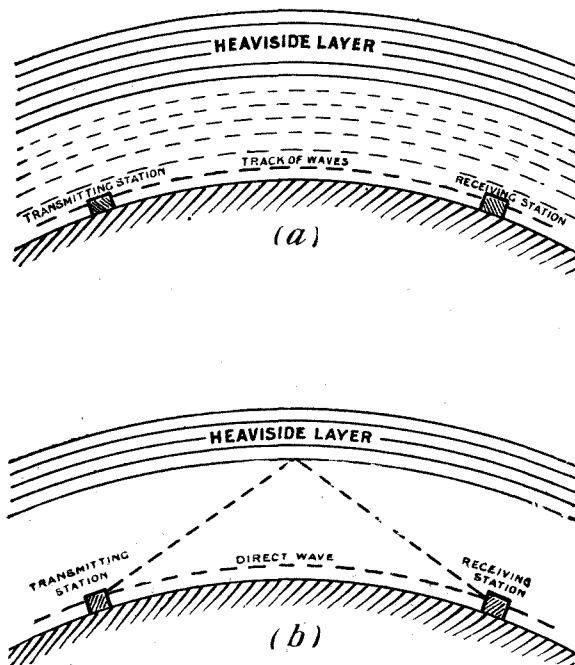

Fig. 26.—Showing how the Heaviside layer is assumed to affect transmission.

will be reflected. By day the whole of the atmosphere down to the surface of the ground is ionised, and by night, when the sun sets, these ions re-combine right up to the level of the Heaviside layer. Thus, as has been pointed out by Eccles, during the day there is no well defined layer at which reflections can take place—Fig. 26 (a)—and so the variations introduced by waves arriving at the receiver in two different directions, one over the surface of the earth and one reflected from the Heaviside layer, are not so likely to occur. By night, however, the lower boundary of the layer forms a good reflector—Fig. 26 (b)—and

hence possibly accounts for the fact that these variations occur principally during this period. They are usually not obtained at distances greater than 100 miles, but under certain circumstances, where the distance is large, and particularly where there is mountainous country either at the source, at the receiver or in between, these variations are obtained. They commence usually about sunset and continue till about sunrise. Very often the actual observed bearings wander, and it is sometimes possible to follow the bearing round. Variations up to 60° or 70° have been observed. Wavelength sometimes has an influence,

although there is not sufficient known about this to say exactly in which way the wavelength affects bearings.

It will be apparent that a good deal of work is still required before a proper understanding is arrived at of the variations experienced in direction finding when working over the land ; but, on the other hand, the errors introduced up to about 100 miles over the sea, a range of particular service to navigation, are negligible, and the immense service of wireless direction-finding in this connection has been amply proved, both as a reliable means of saving time and as a safeguard against disaster.

REGULAR PROGRAMMES FROM BRITISH AND FRENCH BROADCASTING STATIONS

(Times in British Summer Time.)

GREAT BRITAIN.

| Station. | Call | Wave-Sign. | length. | Times. |
|------------|-------|------------|---------|--|
| Cardiff | ... 5 | WA | 353 | 3.30 to 4.30 p.m. (except London) and 5.30 p.m. to 11.0 p.m. London (day transmission) 11.30 a.m. to 12.30 p.m. <i>Sundays.</i> 8.30 to 10.30 p.m. London also 3.0 p.m. to 5.0 p.m. |
| London | ... 2 | LO | 369 | |
| Manchester | ... 2 | ZY | 385 | |
| Newcastle | ... 5 | NO | 400 | |
| Glasgow | ... 5 | SC | 415 | |
| Birmingham | 5 | IT | 42 | |

Silent Periods.

| | |
|------------|-----------------------|
| Cardiff | ... 8.0 to 8.30 p.m. |
| London | ... 7.30 to 8.0 p.m. |
| Manchester | ... 7.45 to 8.15 p.m. |
| Newcastle | ... 9.0 to 9.30 p.m. |
| Glasgow | ... 6.0 to 8.15 p.m. |
| Birmingham | 8.15 to 8.45 p.m. |

FRANCE.

PARIS, EIFFEL TOWER. (FL, 2,600 metres.)

| | |
|------------|-----------------------------------|
| | <i>Weekdays (daily).</i> |
| 7.40 a.m. | Meteorological forecast. |
| 12.15 p.m. | Meteor. forecast and time giving. |
| 3.30 p.m. | Financial bulletin. |
| 6.10 p.m. | Concert. |
| 7.20 p.m. | Meteor. forecast. |
| 11.15 p.m. | Meteor. forecast. |

Sundays.

| | |
|---|-------------------|
| 6.10 p.m. | Concert. |
| 7.20 p.m. | Meteor. forecast. |
| Other concerts specially announced from time to time. | |

PARIS, RADIOLA. (1780 metres.)

Weekdays (daily).

| | |
|------------|--|
| 12.30 p.m. | Information (Cotton Exchange, Havre, Liverpool, Alexandria). |
| 12.40 p.m. | Concert. |
| 5.0 p.m. | Commercial information. |
| 5.10 p.m. | Financial information. |
| 5.20 p.m. | Concert. |
| 8.45 p.m. | News. |
| 9.0 p.m. | till 10.0 p.m. Concert. |

Thursday, 9.45 p.m. till 10.30 p.m. Dancing concert.

Sundays.

| | |
|---------------------------|------------------|
| 2.0 p.m. till 3.0 p.m. | Concert. |
| 8.45 p.m. | News. |
| 9.0 p.m. till 9.45 p.m. | Concert. |
| 9.45 p.m. till 10.30 p.m. | Dancing concert. |

PARIS. SCHOOL OF POST AND TELEGRAPHS.

Tuesday and Thursday.

| | |
|---|----------|
| 8.30 p.m. | Concert. |
| And very frequent radiophone transmissions of plays (comic operas). | |

LYONS. YN, 3,100 metres.

| | |
|------------|-----------------------|
| 10.45 a.m. | Concert (gramophone). |
| 3.35 p.m. | Financial news. |

NICE. RADIO RIVIERA.

| | |
|------------|-------------------|
| 12.0 noon. | News and concert. |
| 6.7 p.m. | News and concert. |
| 9.10 p.m. | News and concert. |

ADDING A HIGH-FREQUENCY STAGE TO THE "ST100"

By A. D. COWPER, M.Sc., Staff Editor.

A highly important and interesting article showing how several valuable modifications of the famous ST 100 circuit can be effected.

THE possibility of utilising the high audio-frequency amplifying power of the "S.T. 100" circuit in the reception of long-distance telephony offers some fascinating problems to the experimenter. While the circuit in the published form readily gives an enormous build-up of moderately-faint signals—such as those obtained from a broadcasting station on a very indifferent aerial some little distance away—for feebler signals an effective stage of high-frequency amplification before it is desirable. Fig. 1 represents the essential part, or nucleus, of the S.T. 100, slightly simplified by replacing the tuning-coil and condenser in the plate circuit by a variometer (which works very successfully in practice).

It is evident we can add a stage of H.F. amplification before, and this arrangement is shown in Fig. 2. But in order to interfere as little as possible with the correct functioning of the nucleus, and also for selectivity it is suggested that in place of close-coupled fine-wire H.F. transformers, ordinary tuning-coils in a two-coil holder be used, with both primary and secondary tuned by small variable condensers; the coupling can then be varied at will, and very great selectivity is possible. On trying this circuit practically it was found to function very well with the two valves, the first H.F., and the second as the S.T. 100 nucleus. It was found possible to get an actual step-up in this H.F. transformer—more often described than actually obtained—by using a No. 35 Igranac tuned by a .0005 variable condenser as primary; and a No. 75, tuned by little more than the minimum capacity

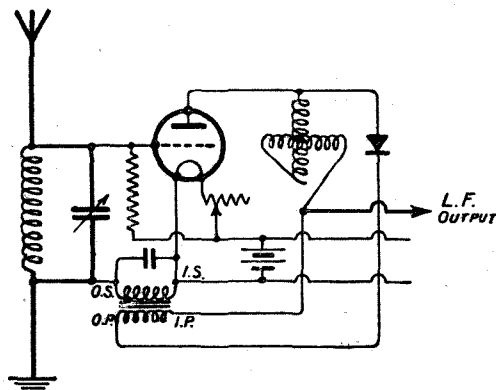

Fig. 1.—The Nucleus of the ST 100 circuit.

of a .00025 Marconi variable condenser, fairly loose-coupled to the first, as secondary. The circuit was very quiet—with little atmospheric noise, A.C. hum, etc., and was easily manageable, giving very good selectivity and good loud-speaking strength on local broadcasting, though, of course, not so loud as the original S.T. 100, with only one L.F. stage. The tuning was much easier than would appear at first sight; the aerial-circuit and second tuned plate had flat tuning (the latter on account of the great damping effect of the crystal);

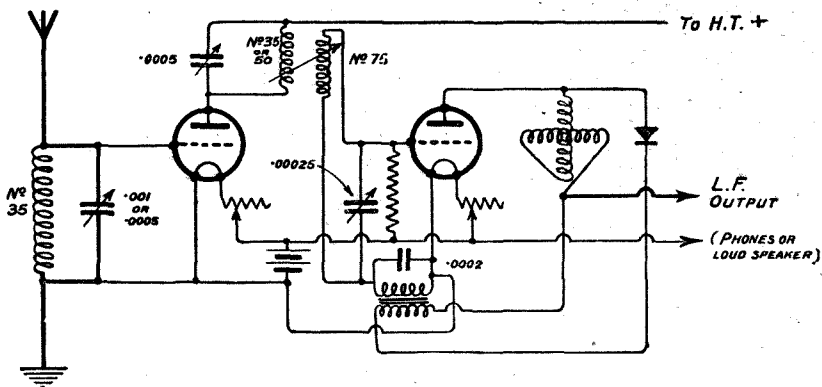

Fig. 2. H.F. Amplifier added to the "ST 100."

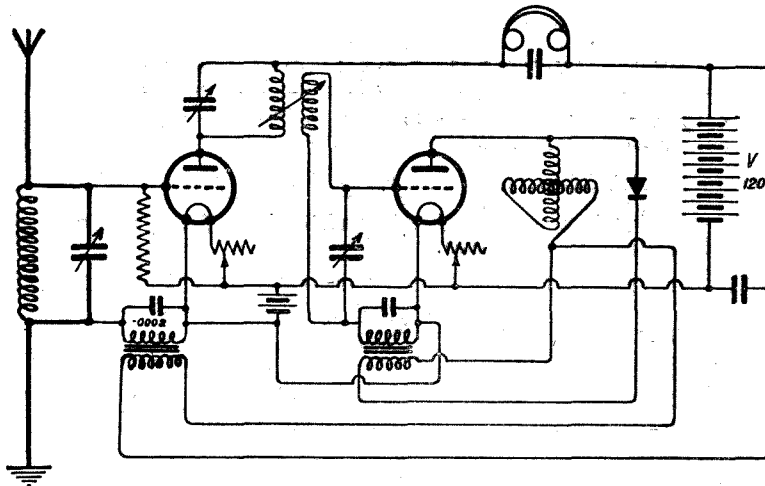

Fig. 3.—A Double ST100 with two stages of H.F. and two of L.F.

and practically all control was by the secondary H.F. transformer condenser. The circuit was also very stable; and the head-phones could be worn with comfort. Both Birmingham and Cardiff were readily tuned in at pleasant strength in the interval of 2 L.O., and during day-light.

The next step was to see if another stage of dual amplification could be adapted to this, so as to give two stages, audio-amplification as well as two stages of H.F. The idea of this modification is to use the first valve for amplifying weak radio-frequency but strong audio-frequency energy, and to obtain the first stage of L.F. amplification, wherein the energy to be handled is still moderate, with the second valve of the series, which is already fairly loaded with H.F., thus distributing the load more fairly. The circuit indicated in Fig. 3 resulted. This on trial proved to be stable enough, but extremely noisy in use. With the phones in the plate circuit of the first valve, any audio-frequency disturbances picked up by the aerial came through amplified, the result was a roar of atmospherics and induction from A.C. electric light mains (the latter had to be shut off at the main switch to be able to bear the phones on the head at all), so that although a very good measure of loud-speaking was obtainable from the local broadcast station,

and plenty of noise from some amateurs, the result on distant stations did not seem to repay the trouble. The tuning, of course, was no more complex than in No. 2.

In order to try and obtain the higher efficiency and relative simplicity or reactance-capacity H. F. coupling, after some experimenting on modifications of Fig. 2 the circuit shown in Fig. 4 was evolved. This gives the two stages of H.F., with one stage L.F., of Fig. 2, utilises the surplus radio-energy as in S.T. 100, of which it is of course

but a slight modification, is very quiet and stable, and can be thoroughly recommended for long-distance reception. As the phones are isolated from the aerial circuit and its valve with only a slender H.F. coupling condenser; atmospheric A.C. induction and stray noises are absent. In practice all tuning is done on the one variable, the plate circuit variometer (or equivalent coil, e.g., Igranic No. 50, and tuning condenser). The tuning on the aerial variometer and second plate variometer is flat as in Fig. 2. Of course any or all of the variometers can be replaced by coils and tuning condensers, according to the resources of the experimenter's apparatus cupboard. The small coupling condenser is set at a very low value, if howling is to be avoided—only some 10 degrees of a Marconi .00025 variable was found best; it is then left undisturbed, so could be replaced in due course by a small

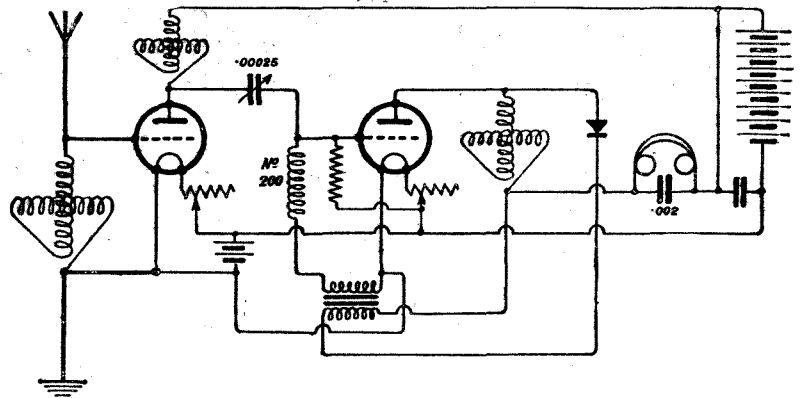

Fig. 4.—A Variometer Tuned Circuit with two stages of H.F. and one of L.F.

fixed condenser. The radio-choke of No. 200 size is essential; larger coils bring in growlings. The fairly large bridging condenser across the transformer secondary should be noticed.

It is evident that a note-magnifier can be added to this, as in the original S.T. 100, which will give an extremely powerful and sensitive circuit, but one that is at the same time quite stable (especially if carborundum crystal, without applied potential, be used

with firm contact), and easy enough to tune. Without a note-magnifier the reception of local broadcasting is very satisfactorily loud on the loud-speaker.

NOTE.—In some cases the 70,000 ohm grid leak could be dispensed with. Grid-bias, of from 1.4 to 4 volts negative, should generally be applied to both valves, by grid cells between "I.S." of L.F. transformer and the filament; it is omitted in the diagrams for the sake of simplicity.

WIRELESS ON THE CAR.

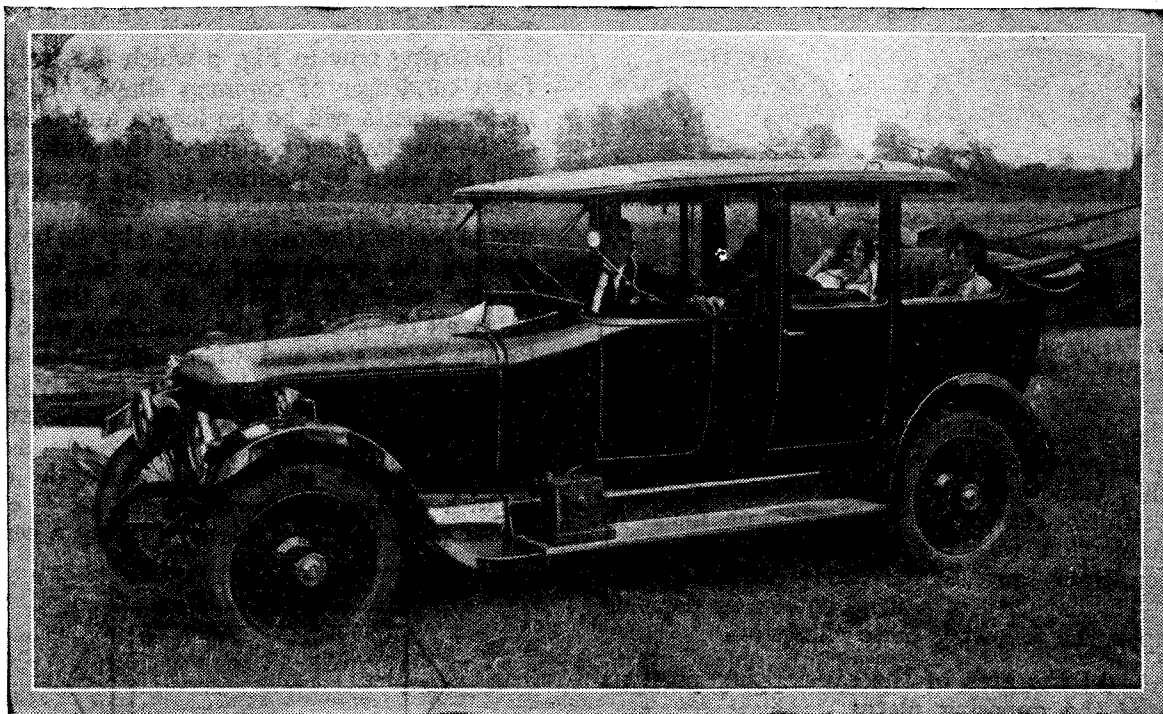

This Daimler car, fitted with a roof aerial consisting of a metal plate, is seen on the banks of the Avon at Stratford, where it successfully received both London and Birmingham broadcasting. A story of the outing is given on page 522 of this issue.



THE MEASUREMENT OF WIRELESS QUANTITIES.

By E. H. CHAPMAN, M.A., D.Sc., F.R.Met.Soc. (Staff Editor).

II.—CAPACITY OF FIXED CONDENSERS.

In this, the second article of a series, Dr. Chapman shows how the capacities of fixed condensers are easily and rapidly measured.

TWO important things to bear in mind with regard to the construction of a fixed condenser are that a certain capacity has to be obtained and that, when once the condenser has been assembled, its capacity value cannot be altered without a good deal of trouble. In constructing a



Fig. 1.—Illustrating overlap of condenser plates.

variable condenser, a particular *maximum* value is aimed at and, if that maximum value is exceeded, no harm is done since the value aimed at is included in the range of the condenser. With a fixed condenser, however, the wireless experimenter sets out to obtain a definite capacity value or to get as near to that value as his measurements and material permit. Hence the measurements made in connection with the construction of a fixed condenser must be extremely accurate.

The capacity of a fixed condenser depends upon the following three things:—

- (i.) the area of the overlapping portions of the opposing plates,
- (ii.) the type of non-conducting material sandwiched between the metal plates, and
- (iii.) the thickness of that material.

Of these three things (i.) and (iii.) must be measured with care and accuracy. By assuming that all our condensers will be made with mica between the metal plates we shall not be concerned at all with (ii.).

Dealing first of all with (i.), it is important to obtain a clear idea of what is meant by overlapping. If a penny is placed exactly on the top of a second penny, the overlapping

area is that of a penny. If, however, a halfpenny is placed on the top of a penny, the overlapping area is that of a halfpenny (see Fig. 1). From this illustration it will be evident that, where two opposing plates of a fixed condenser are of unequal area, the overlapping area will be that of the smaller plate.

Referring now to Fig. 2 which illustrates a fixed condenser of common shape, our first measurements will be the length and breadth of the overlapping portion of the plate as it will be when in position in the condenser. Should the opposing plate be smaller and take up the position indicated in Fig. 2 by the broken outline, the overlapping area would be that of the rectangle EFGH. If, on the other hand, all the plates of the condenser were made to the same size and when assembled were made to fit over each other exactly, the overlapping area would be that of the rectangle ABCD.

Measurements such as the length and breadth of the overlapping area of a condenser plate can be made by placing a centi-

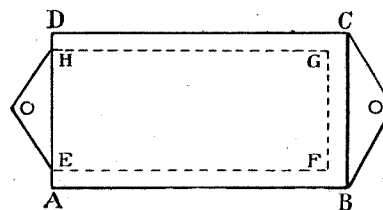

Fig. 2.—A typical fixed condenser.

metre scale on the plate, but the use of a pair of dividers would give more accurate results.

To measure AB with dividers, one point of the dividers would be placed at A and the other at B. The dividers would then be transferred to a centimetre scale, one point being placed on the zero mark, the other point giving the required reading.

Our next measurement, the thickness of the mica to be used, is so small that it is necessary to make use of some accurate measuring instrument. There are a number of well-known types of such instruments to choose from.

Fig. 3 illustrates a micrometer screw-gauge with which measurements can be made to the hundredth part of a millimetre. Such an instrument is somewhat expensive. The present writer has frequently made use of the type of sliding callipers illustrated in Fig. 4 for measuring the thickness of mica.

Sliding callipers cost only a few shillings and they would prove a valuable addition to the collection of tools to be found in the possession of the serious experimenter.

Failing either of these instruments, use could be made of the familiar standard wire gauge illustrated in Fig. 5. Various trials will give a result in which a certain number of sheets of the mica will fit into one of the gauge slots with precision. Reference to the table provided (Fig. 6) will then give the required thickness of mica to a considerable degree of accuracy. For example, suppose that three sheets of mica fit into gauge slot 28. From the table in Fig. 6 we see that the thickness of the mica is $\cdot 12$ millimetres. Whether a

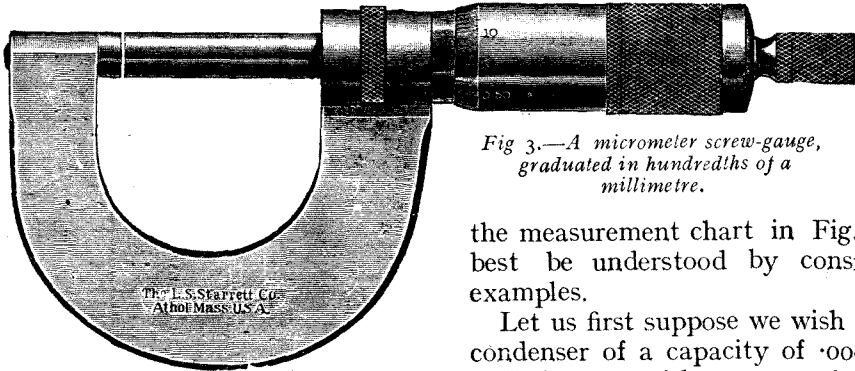

Fig. 3.—A micrometer screw-gauge, graduated in hundredths of a millimetre.

measuring instrument or a standard wire gauge be used, it is a good plan to take the thickness of the mica a number of times either for different sheets or at different places on the same sheet or bundle of sheets. An average value should then be worked out and used in the calculations.

The manner in which the measurement chart in Fig. 7 is used can best be understood by considering actual examples. Let us first suppose we wish to make a grid condenser of a capacity of $\cdot 0003$ microfarads and that we wish to use only two opposing plates. Suppose also that the mica to be used has a thickness of $\cdot 12$ millimetres. Our problem is to determine the area of the overlapping portions of the two opposing plates. To get this area, we place a ruler across the measurement chart so that its edge passes through the reading $\cdot 0003$ microfarads on Scale V. and through the reading $\cdot 12$ on

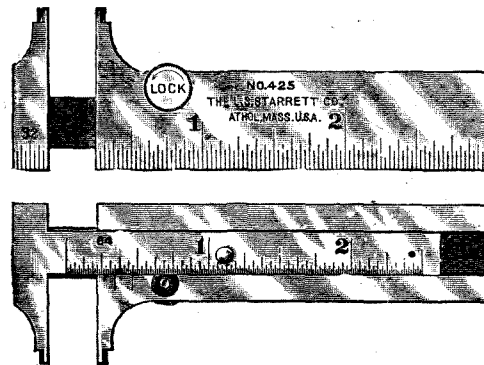

Fig. 4.—Sliding callipers.

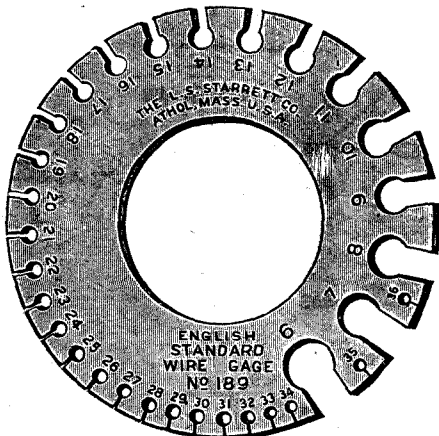

Fig. 5.—A standard wire gauge.

Scale I. The edge of the ruler in this position is indicated in Fig. 7 by the straight line AB. We note that the edge of the ruler crosses Scale III. at a point giving a reading of $6\cdot 75$ square centimetres. This reading gives the required area of the overlapping portion of the condenser plates. The length and breadth of this overlapping portion are entirely at our choice. We can place a ruler so that its edge passes through the point $6\cdot 75$ on Scale III. and move it about to cross Scales II., III. and IV. at any angle, always provided of course that the edge passes through the point $6\cdot 75$

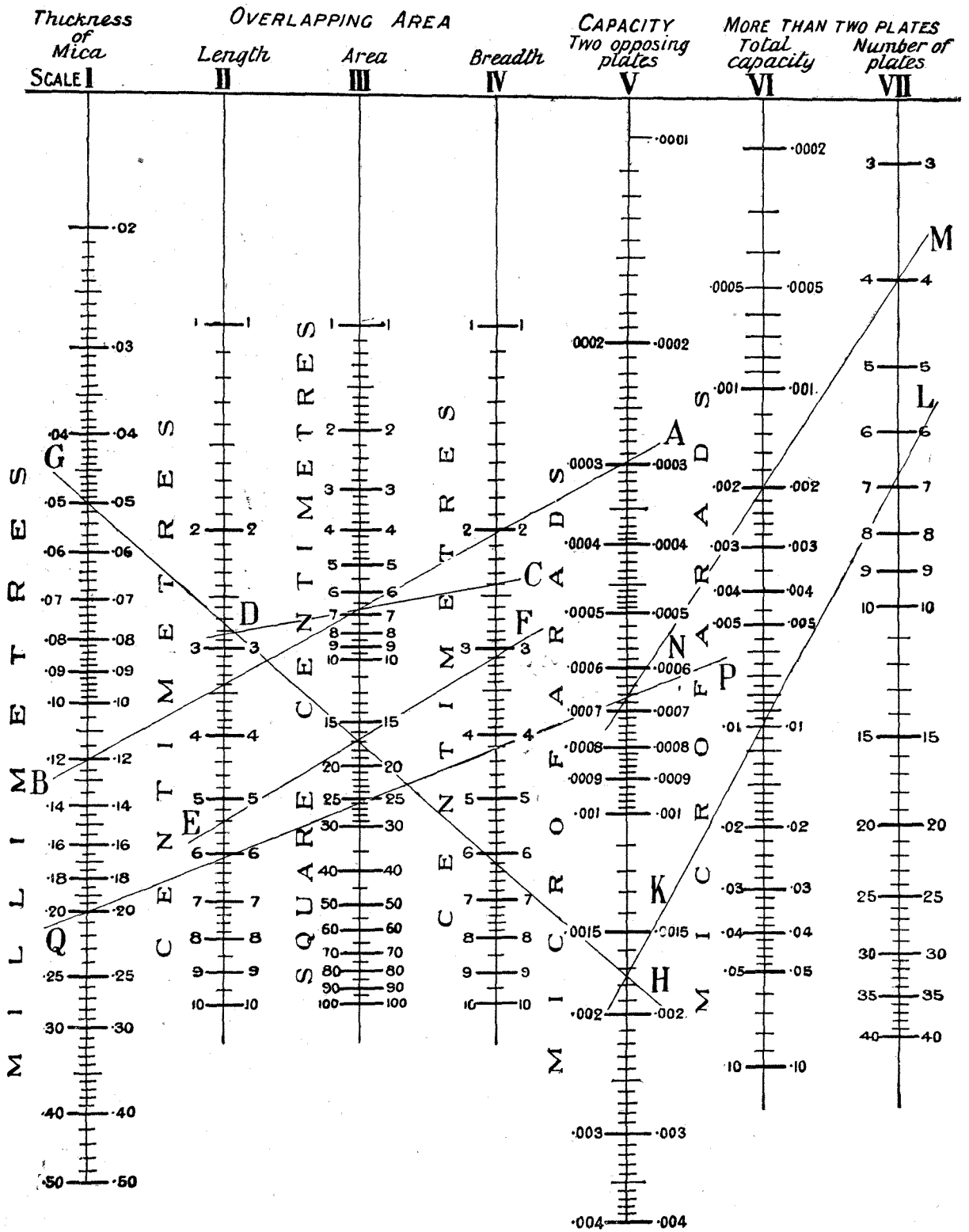

Fig. 7.—The condenser measurement chart.

on Scale III. This is a great convenience and will save much trouble when condenser plates have to be cut. Suppose that the breadth of a strip of copper foil to be used in making this grid condenser is 2.4 centimetres. To get the length of the overlapping area we place a ruler with its edge in the position indicated in Fig. 7 by the straight line CD. The edge of the ruler in this position passes through the

a ruler across Scales II., III. and IV. so that its edge passes through the reading 5.4 on Scale II. and through the reading 3.1 on Scale IV. The edge of the ruler gives us a reading of approximately 17 on Scale III. (see line EF on chart). Next we place the ruler so that its edge passes through the reading .05 on Scale I. (thickness of mica) and through the point where line EF crosses Scale III. Incidentally there is no need to bother taking readings from Scale III., but the numerical scale provided will save the continuous drawing of lines across the chart. In this last position, the edge of the ruler will be in the position indicated by line GH on the chart. We now place our ruler so that its edge passes through the point where GH cuts Scale V. (approximately .00185 microfarads) and through the reading .01 on Scale VI. The line KL indicates the edge of the ruler in this position. Where KL cuts Scale VII. gives us the number of plates which must be put into the condenser. Since KL cuts Scale VII. nearer to 7 than to 6, and also in order that our condenser should exceed rather than fall short of the value .01 microfarads, we should put 7 plates in the condenser.

In order to show how elastic is the use of this measurement chart, let us consider as a third example the construction of a fixed condenser of capacity .002 microfarads when the number of plates must be 4 and the mica to be used is .2 millimetres thick. Let us also make the stipulation that the plates of the condenser must be square. Our problem is then to find the side of the square plates. The work is as follows:—

| Position of edge of ruler. | Indicated by line | Note. |
|----------------------------|---|--|
| First | MN 4 on Scale VII., .002 on Scale VI | Crosses Scale V. at point .00066. |
| Second | PQ .00066 on Scale V., .2 on Scale I. | Crosses Scale III., at point 26. Gives required reading of 5.1 cms. on either Scale II. or IV. |
| Third | RS Right across Scales II., III. and IV. perpendicular to all these three scales and passing through point 26 on Scale III. | |

Result:—The condenser plates must be 5.1 centimetres square.

NUMBER OF SHEETS.

| Gauge Number: | 1 | 2 | 3 | 4 | 5 | 6 |
|---------------|-----|-----|------|------|------|------|
| 18 | — | — | .40 | .30 | .24 | .20 |
| 20 | — | .46 | .30 | .23 | .18 | .15 |
| 22 | — | .36 | .24 | .18 | .14 | .12 |
| 24 | — | .28 | .17 | .14 | .11 | .09 |
| 26 | .46 | .24 | .15 | .11 | .09 | .08 |
| 28 | .38 | .19 | .12 | .09 | .08 | .063 |
| 30 | .31 | .16 | .10 | .08 | .063 | .050 |
| 32 | .27 | .14 | .09 | .07 | .055 | .046 |
| 34 | .23 | .12 | .08 | .058 | .047 | .039 |
| 36 | .19 | .10 | .064 | .048 | .039 | .032 |
| 38 | .15 | .08 | .051 | .038 | .030 | .025 |
| 40 | .12 | .06 | .04 | .03 | .024 | .02 |

Millimetres.

Fig. 6.—Measurement of thickness of mica by means of a standard wire gauge.

point 2.4 on Scale IV. (breadth of overlapping area) and through the point 6.75 on Scale III. The reading 2.8 indicated by the edge of the ruler on Scale II. gives the required length of the overlapping area of the condenser plate.

For the construction of small fixed condensers it will be evident that the measurement chart given herewith will enable the experimenter to use up odd bits of copper foil which he might otherwise have discarded as useless.

As a second example, let us consider the construction of a fixed condenser of capacity .01 microfarads from pieces of copper foil which give an overlapping area of length 5.4 centimetres and breadth 3.1 centimetres. Let us further suppose that the mica to be used is .05 millimetres thick. The problem is to determine the number of metal plates or foils to be put in the condenser to give the required capacity value.

Using the measurement chart, we first place

Fig. 8, which gives equivalent measurements in inches and in the metric system, is provided with a view to helping those experimenters who already have measuring instruments graduated in inches and decimals of an inch.

By changing measurements made in inches and decimals of an inch to centimetres and millimetres the measurement chart in Fig. 7 can be made full use of.

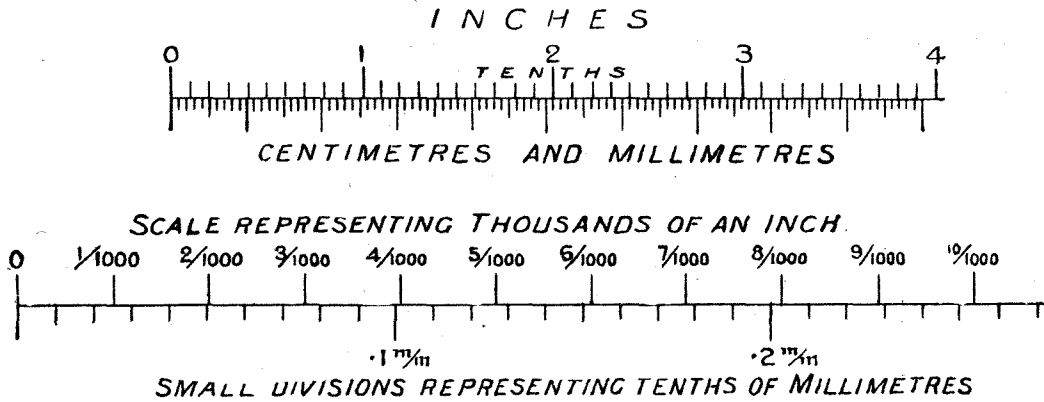

Fig. 8.—Conversion scales

ULTRA-SONIC WAVES FOR SUBMARINE
SIGNALLING

M. LANGEVIN has delivered a lecture recently before the Marine Academy on the use of ultra-sonic sound-waves for submarine signalling.

These waves are sound-waves above the human range of audibility and constitute apparently the only means of directive signalling and detection for submarine use. Wireless waves are absorbed by a thickness of sea-water of a few metres, and light-waves are equally incapable of penetrating any considerable distance.

The shortness of the waves used, which have a frequency of 30,000 to 100,000 per second, enables them to be emitted in the form of a beam, rendering directive signalling very easy. This sound-beam is also useful for exploring submarine regions, and particularly for "sounding" and for the detection of icebergs by means of the reflection of the waves from the berg.

The apparatus employed consists of a block of quartz and steel, the action of the arrangement depending upon the piezo-electric proper-

ties of quartz discovered in 1880 by Curie. The device is connected to a high-frequency electrical generator, similar to those employed in wireless telegraphy and is submerged beneath the surface of the water; the electrical energy is transformed into ultra-sonic waves of the same frequency as the oscillations in the applied alternating current, and a sound is sent out in a form of a beam, which may be rotated at will. Conversely, the ultra-sonic waves which fall upon such an apparatus are transformed into electrical oscillations, which may be amplified and detected by ordinary wireless methods, in fact the practical solution of the problem of ultra-sonic signalling has only been rendered possible by the use of such amplification.

This new apparatus serves both as transmitter and receiver just as the wireless aerial serves the double purpose in wireless telegraphy: it constitutes in fact a submarine aerial for directional transmission and reception.

[Le Radio].

THE DEVELOPMENT OF HIGH-POWER SILICA VALVES

By Dr. J. H. T. ROBERTS.

This is a fascinating account of the researches which have been made upon the problem of the anode heat dissipation in high power valves. The article includes an account of the work of H.M. Signal School, Portsmouth (from a lecture before the Institution of Electrical Engineers, by Col. H. Morris-Airey) and of that of the Mullard Radio Valve Co., Ltd.

THE development of high-power transmitting valves in this country for naval purposes dates from about 1916 and has been largely due to the work carried on at H.M. Signal School, Portsmouth. At about the date mentioned, the "Round" valve, for heterodyne purposes, and also the "Oscillon" valve had been developed, and the latter was employed in an experimental transmitter which had been designed for use in seaplanes.

The researches which have been devoted to the production of high-power transmitting valves have been well justified and have no doubt exerted considerable influence upon wireless development in various parts of the world.

The problems which had to be investigated related partly to the electrical design of the valve and partly to the choice of suitable materials for the envelope, and the proper mechanical construction. The following account deals with the manner in which these problems have been investigated and more particularly with the employment of silica envelopes for the valves, for the purpose of withstanding the very large heat radiation when transmitting large powers.

At about the end of 1916 a valve transmitter had been made which was capable of producing a current of 4 amperes in the aerial of H.M.S. *Vernon*, Portsmouth, and which permitted the transmission of signals from Portsmouth to the naval station at Aberdeen. The electrical design of the valve was influenced by the publication at about this time of the work of Dushman and Langmuir on pure electron dis-

charges, and it may be said that this particular aspect of valve design was then beginning to be fairly well understood. With the production of higher powers, however, the problem of providing a suitable envelope for the valve became more acute and investigations eventually led to the adoption of silica, which material has proved very satisfactory for this purpose. The development of the silica valve has been principally carried out by H.M. Signal School and the Mullard Company, and Signal School has embodied the results of the work in a considerable number of official patents.

Design of Transmitting Valves

The specification to be followed in the case of a transmitting valve is usually based on the rating of the valve and the d.c. voltage which is available for the anode supply.

Anode.—The rating of the anode is the average power which it is able to dissipate under normal working conditions. This dissipation takes place almost entirely by radiation, and the amount of the radiation per square centimetre of the surface can be fixed when the maximum temperature at which the anode may safely be run is known. It has been found in practice that between 35 and 45 watts per square centimetre may be dissipated, the actual amount depending upon the nature of the anode material. It will be seen that the determination of the necessary anode area is thus a comparatively simple matter. The anode is conveniently made in the conventional cylindrical form, and the relator

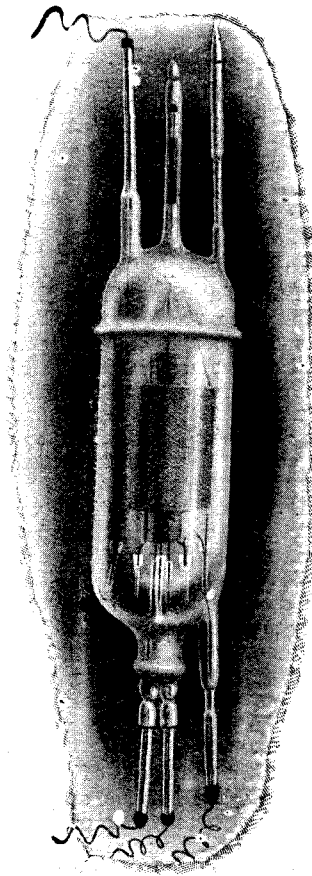

Fig. 1. A 2.5 kw. silica valve.

between the length and the diameter of the anode may be made subservient to practical considerations—for example, to the most convenient size of the cylindrical envelope.

Filament.—The value of the emission current from the filament is determined from a consideration of the total energy which it is desired to give up to the anode per oscillation and the effective mean anode voltage during the part of an oscillation when the anode current is flowing. The maximum working temperature of the filament will depend upon the material and upon the intended life of the filament. In practice this temperature is about 2,000 degrees Centigrade, and as the emission from a tungsten wire, whether pure or thoriated, has already been investigated, it is easy to specify the filament area. For a given area, the diameter of the filament will depend upon its length, and it is found desirable to arrange for the length of the filament to be somewhat greater than the length of the anode; the reason for this will be mentioned later on when we describe the process of bombarding the anode in the final stages of the evacuation of the valve.

Grid.—The practical success of the valve depends upon the grid, the dimensions of which now remain to be determined. The constant μ of the valve to be aimed at depends upon the circuit conditions under which the valve is to be used, the coupling arrangement of the grid and anode circuits, the amplitude of the oscillations to be produced and the ease with which the circuit can be set into self-oscillation. This constant μ is a function of the anode and the grid diameters, the grid spacing, and the diameter of the wire from which the grid is made: its numerical value for the valves in question may be between 20 and 30, but it is possible to use a valve for which the value μ of is as high as 250.

The diameter of the anode having been fixed, practical considerations govern the grid diameter and the diameter of the grid wire; hence the grid spacing is determined and the electrical design of the valve is complete.

At about the commencement of 1917 the design of valves with glass containers was proceeded with

on the lines indicated above, and a valve of 500 watts rating could easily be produced. It was not long before a glass valve of 800 watts rating was successfully constructed and used. It was largely in the employment of the latter valve, however, that the limitations of glass as the material for the envelope became evident. It was seen that serious difficulties with the glass container would be encountered with any further increases in the rating of the valve, and in fact an experimental valve designed to have a rating of 3 kw. was a failure from this cause. There appeared to be no real difficulty in the electrical design of high-power valves, and it was thought that, provided a suitable heat-resisting envelope could be obtained, which would also permit the maintenance of the very high vacuum, there should be no immediate limit to the power which could be dissipated. At this time a valve rated for an anode dissipation of about 4 kw. was aimed at.

Methods of Cooling

The heat generated at the anode is under some conditions very great, and the problem of getting rid of this heat was not an easy one. Various methods suggested themselves, of which one was to make the anode in the form of a coil of metal tubing through which a fluid could be passed whilst the valve was in operation. The practical trial of this method has been postponed owing to the fact that certain difficulties in its employment were foreseen, and other methods have been found more immediately convenient.

A second suggestion was to make the cylindrical anode serve also as the outer wall or envelope of the valve. It was obvious that the cooling would in this case be a very simple matter. This method has, as a matter of fact, been tried with some success, and it is possible that at a future date it may be adopted for very high powers.

Another method of rather a different kind is the substitution for the glass envelope of the valve of a material which has a high diathermancy (transparency to heat) and a low co-efficient of thermal expansion. The substance which at once suggests itself is silica, which, in addition to the properties already mentioned, has

also a very high melting point. This material has now been successfully used for the containers of high-power valves, and the results obtained have been extremely encouraging, although in the early stages many serious technical and manufacturing problems had to be solved.

Silica Valves

From the point of view of the actual construction of the valve envelope, the pre-eminent advantage of silica is its very low co-efficient of thermal expansion; this renders it almost entirely free from the liability to crack when subjected to sudden local heating or cooling, and permits the making of many complicated mechanical designs which would be quite impossible with glass. When it is considered that some of the valves are three or four feet in length and perhaps fifteen inches in diameter, and that they have numerous side-tubes attached, it will be realised that the manufacture of such an envelope in glass would present a serious glass-moulding problem. Furthermore, it is frequently desired to open up the envelope in order to replace electrical parts, and with silica this opening up can easily be accomplished by means of simple rotary tools such as those employed by dentists, the re-sealing being accomplished by means of the oxygen-hydrogen blow-pipe. In the bombardment of the tubes in the final stages of the evacuation, the silica vessel may be allowed to heat up to a much higher temperature than glass would withstand and afterwards it may be cooled by means of an air blast without any fear of damage. Anyone having experience of glass manipulation will realise that the procedure mentioned above would lead to endless trouble with a glass envelope. The only important disadvantage in the use of silica is its high first cost, but having regard to the extreme facility with which it may be manipulated, as well as its technical possibilities, the matter of cost is comparatively insignificant.

Sealing-in of Leads

In the case of electrical leads through glass, advantage is taken of the fact that the co-efficient of expansion of platinum is approximately the same as that of glass,

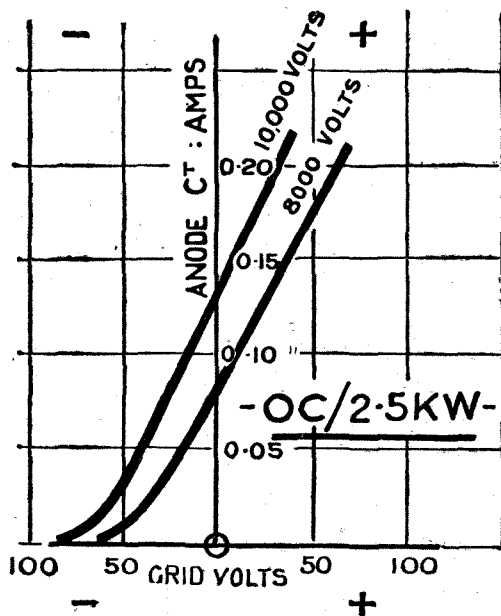
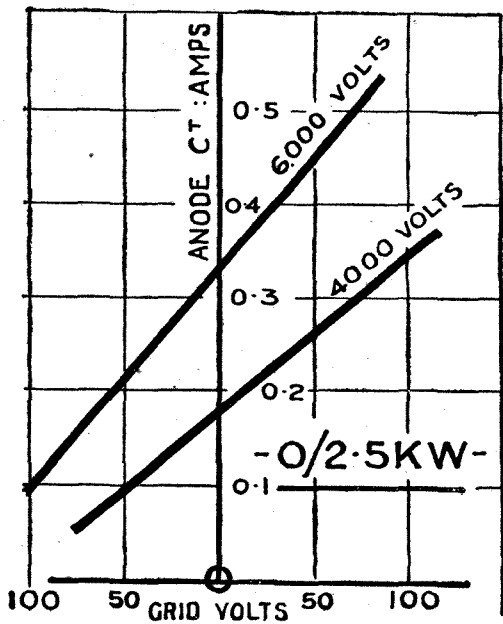
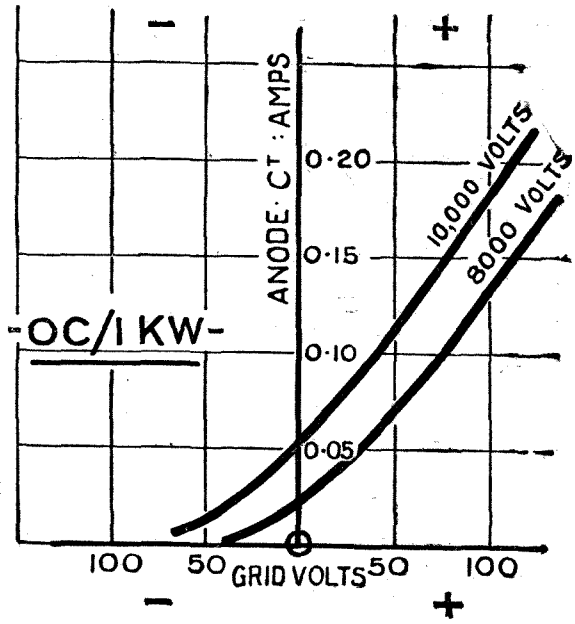
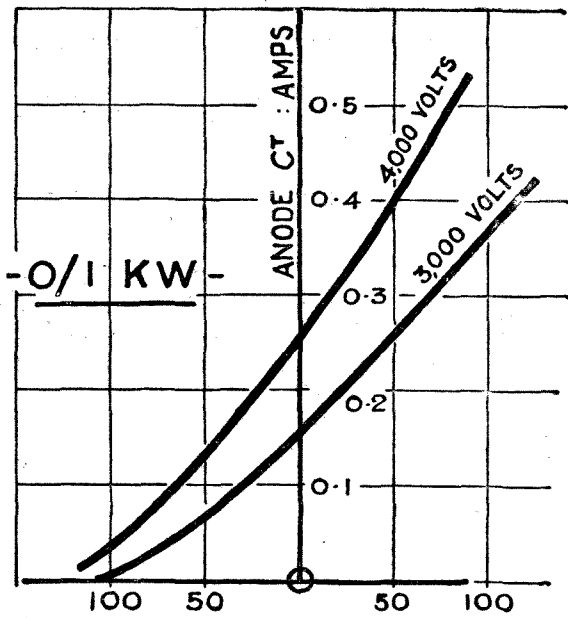

Fig. 2.—Characteristic curves of large transmitting valves, showing the effect of varying plate voltages,

and consequently an air-tight seal is easily made in glass by means of platinum wire. With silica, however, this circumstance is not available, and a certain amount of experimental work has been carried out on the question of the most suitable seal for the leads into the silica envelope. A seal recommended by the Silica Syndicate, with some modifications by Signal School, has been found very satisfactory up to a current-carrying capacity of over 20 amperes. This method consists essentially in the employment of a molybdenum wire sealed into a silica tube by means of a long sleeve of lead.

Although the silica has obvious advantages in regard to its natural properties, the manufacture of large size silica envelopes was found to be a matter of some difficulty, and it was not until the beginning of 1919 that a really satisfactory silica bulb of the necessary dimensions had been obtained and fitted up into a valve rated at 2 kw. Many further difficulties were experienced in connection with the bombardment of the electrodes and exhaustion of the vessel, and it was not until about November, 1919, that the first large silica valve was completed and sealed off. Unfortunately, this valve, which would otherwise almost certainly have been a success, was insufficiently exhausted, with the result that in operation it became considerably over-heated.

The employment of silica for the valve envelopes, however, had shown such definite promise that H.M. Signal School set to work seriously to study the manufacturing side of the problem. The existing valve laboratory at Signal School was extended and special arrangements were made for work on high-power valve construction. It is interesting to note that the substitution of special metal tables, strengthened by lattice frames, instead of the wooden benches which had previously been employed for small valve work, led to the disappearance of one of the most frequent troubles, namely, the cracking of the glass tubes which were employed for connecting together the valves and the mercury-vapour pumps and subsidiary apparatus. Eventually it was found necessary to eliminate all joints of foreign material, and the whole of the apparatus, including the valve, the gauges, and the pumps, was

constructed throughout of silica fused into one continuous piece.

Exhausting the Valves

It has already been mentioned that the Mullard Valve Company had collaborated in the development of the silica valve, and by the end of 1920 it was possible to obtain from the Mullard Company silica valves which were complete except as regards bombardment and exhaustion.

In 1921 an attempt was made to produce a 10 kw. valve, and towards the end of that year a valve was actually exhausted and sealed capable of dissipating $9\frac{1}{2}$ kw. under working conditions. The bombardment of this valve was found to be a very arduous task, necessitating continuous attention on the part of the laboratory staff for about thirty hours. In view of the necessity of reducing the manufacture of such valves to a proper commercial basis, a careful study was made of the times at which the principal evolution of the gas took place, both from the silica and from the metal, and as the result of these investigations it was eventually possible to reduce the bombardment period for a 24 kw. valve to about one hour. This result was obtained, amongst other things, by making all the silica and metal employed in the construction of the valve scrupulously clean, and also by taking the greatest possible care that no oxidation of any of the metal parts should occur during the assembly. After the assembly the valve is continuously baked and pumped.

Anode Bombardment

The emission current employed in the case of the 24 kw. valve, during the process of bombarding the anode in the last stages of the exhaustion, was about $3\frac{1}{2}$ amperes. During this process a certain wastage of the filament took place, but it was found that this wastage was practically negligible. Any diminution in the diameter of the filament will result in an increase in the resistance of the filament, and therefore, in order to produce a given current through the filament, a greater voltage will be required. In an actual case it was found that in order to produce a heating current of 20 amperes, the filament voltage before bombardment was 36.1 and after bombardment 36.2.

Pressure Indications

During the process of pumping, an ordinary McLeod gauge is employed to indicate the pressure down to about 0.00001 millimetre of mercury. Below this pressure the ammeter in the anode supply circuit acts as an indicator of the evolution of gas from the anode and other parts. It is found that the reading of the ammeter gradually increases when gas is being evolved, whereas when the bombardment is complete, so that there is no further evolution of gas, the reading of the anode ammeter remains absolutely steady.

Some Curious Effects

At the commencement of the bombardment it is sometimes found that on switching on the full anode voltage (the grid being at, perhaps, 300 volts) there is practically no emission current whatever, whereas the normal emission current to be expected under the circumstances may be as much as $3\frac{1}{2}$ amperes. This effect will sometimes persist as long as fifteen minutes, when the normal emission will suddenly set in and afterwards remain steady.

Another remarkable effect which is frequently observed with these large valves is a diminution in the brightness of the filament at the moment when the anode voltage is applied. When the valve is working normally, however, the anode quickly heats up, so that the dimming effect, if it persists, is masked.

It is difficult to account for this dimming effect of the filament, but it has been suggested that it is due to the so-called "latent heat of evaporation" of electrons. In the case in question, the absorption of energy, according to Richardson's theory, would be about 15 watts. The watts consumption of the filament under these conditions is about 720, but it is possible that the emission taking place from the thin outer layer of the filament may cause a momentary lowering of the surface temperature sufficient to account for the observed effect.

The Life of the Valve

The filament is, of course, the part most likely to require replacement, and upon the life of the filament usually depends the life of the valve. In some of the earlier designs it was found that the filament became slack after some 500

hours' use, and the electrostatic forces between the filament and the grid caused one leg of the filament to be pulled over to the grid, with the result that the filament was destroyed. In later designs, however, this difficulty has been successfully overcome, and some of the valves made at Signal School have been in use over 1,000 hours

without showing any signs of deterioration.

The use of silica valves enables a large power output to be obtained from a wireless transmitting installation of comparatively small dimensions, and consequently this type of valve is particularly advantageous on board ship, which is one of the reasons why H.M. Signal

School has devoted so much attention to its development. Silica valves of 1 kw. up to 4 kw. rating are now manufactured by the Mullard Company as a commercial article, although a large proportion of the output of this type of valve has up to the present been absorbed in the fulfilment of Admiralty orders.

| TYPE | Max. Anode Dissipation | Filament Volts | Filament Amps. | Anode Volts | Satn. Current Amps. | Length Overall | | Diameter | |
|------------------------|------------------------|----------------|----------------|----------------|---------------------|----------------|------|----------|------|
| | | | | | | Ins. | Cms. | Ins. | Cms. |
| O 1 KW. U 1 KW. | 1 KW. | 14 | 10 | 4000 | 0.6 | 24 | 60 | 3½ | 8 |
| OC 1 KW. UC 1 KW. | 1 KW. | 10 | 20 | 10000 to 12000 | 1.1 | 24 | 60 | 3½ | 8 |
| O 25 KW. U 25 KW. | 25 KW. | 16 | 14.5 | 6000 | 1.0 | 24 | 60 | 4 | 10 |
| OC 25 KW. UC 25 KW. | 25 KW. | 18 | 40 | 10000 to 12000 | 3.0 | 27 | 68 | 4 | 10 |
| U 4 KW. | 4 KW. | 21 | 20 | — | 1.5 | 25 | 64 | 4½ | 11.5 |

Table giving interesting details of various transmitting valves.

The "Turret" Mast.

We have received from Messrs. Simpson and Blythe an illustrated list of their well-known "Turret" aerial masts. The particulars given indicate that these masts are very soundly constructed upon good engineering principles. They are supplied in a variety of sizes, complete with all the requisite accessories. One of their special features is their lightness.

DIRECTIONAL WIRELESS, ON SHIP OR SHORE ?

By Lt.-Col. HAROLD F. TOWLER.

In this article the author discusses the highly important point as to whether the direction finding apparatus should be located on the vessel itself or on land. His conclusions point to the advisability of fitting the gear on the ship.

THERE has been discussion amongst technical experts for some time as to whether the best position for the wireless direction finder was on board the ship or whether it should be on shore. The report of Mr. F. W. Dunmore of the Bureau of Standards, U.S.A., appears to have convinced the U.S. Government that the place for the direction finder is on board the ship. I gather this information from a very interesting chapter in C. W. Taussig's book "The Book of Radio."

This decision is the more interesting in view of the large number of shore stations that the American Government have erected for direction finding purposes.

There is one very important point in this matter that does not seem to have received the attention it deserves, and that is the great assistance that wireless direction finding can be to the saving of life at sea.

We all know the ... --- ... call which interrupts all traffic and sends every ship in the vicinity to the help of the ship in distress, but possibly few people realise the difficulty that may be experienced in reaching that ship with the minimum loss of time. Of course, in some cases, where the ship in distress may be on fire, the problem is not difficult, for her position is indicated for many miles by columns of smoke; but if we take the case of a steamer which has struck an isolated rock, submerged wreckage, or ice, in foggy weather, the SOS call is sent out together with the estimated latitude and longitude in which she is. If she has unexpectedly struck a rock, it is quite obvious that she is not in the position she was expected to be in—but in any case, there is no time for very great care in carefully calculating the position—the swinging out of lifeboats, attention to the discipline of the ship and many other things distract the captain from giving very detailed attention to figures. The ship receiving the SOS call

also cannot be certain of her position within a mile or two, the weather being foggy she can only rely on her estimated position, unless she happens to be within sound of any fog signal which might assist her. It is therefore quite within the bounds of possibility that the combination of these two approximations of position may leave an error of as much as five miles from the actual position. And five miles in foggy weather; exercising the caution necessary to prevent striking the same danger which has placed the other vessel in distress, takes a lot of searching and contact may be eventually established only by sound.

Mr. Taussig gives a very interesting example in the case of an accident which happened on the night of August 6, 1920, to the United States steamer *Alaska*.

The *Alaska* was bound from Portland to San Francisco with 136 passengers and a crew of 84 on board when she struck Blunts Reef, off Cape Mendocino in Northern California, during a thick fog, and sunk in half an hour.

The accident happened at 9.15 p.m., and during the half hour that elapsed before she sank the *Alaska* sent out distress signals. The first arrival on the scene of the accident was the steamer *Anyox* who was ten miles away when the *Alaska* struck. The *Anyox* arrived at 11.15 p.m., and with the assistance of other vessels which arrived later, saved many lives, but 42 lives were lost.

The steamship *Wahkeena*, who promptly answered the *Alaska's* distress signal, did not reach the scene of the accident until 7.30 a.m. the next day—although by her estimated position she was only 14 miles away. Mr. Taussig says that "For two hours prior to the grounding of the *Alaska*, its radio operator had been trying to obtain radio bearings by transmitting to the Radio Compass station at Eureka, California, but had been unable to get into communication with that station.

The failure to obtain bearings was due in part to the fact that a large number of ships were endeavouring to obtain bearings at the same time."

This case seems a striking example in support of the American decision that the direction finder should have been on board the ship. If the *Alaska* had had a direction finder during those two hours before she struck there would have been no doubt as to her position or that she was steering a dangerous course. Instead of an enormous volume of signals appealing to the shore station for bearings, there need have been no disorganisation of wireless traffic. The ships would have fixed their position as often

as a check was considered advisable without having to transmit a single message, and they would have been able to treat the shore wireless stations exactly as though they were lighthouses that they could see. Even if the *Alaska* had not had a directional wireless set on board, and the accident had occurred—provided other vessels in the vicinity had had directional wireless on board—they would have been led to the actual scene of the accident by the S O S signals sent out during the 30 minutes before she sank, and would have been able to check their own positions by occasional bearings of the shore station to prevent the danger of running on to Blunts Reef themselves.

A FRENCHMAN ON ENGLISH AMATEURS.

M^LLEON DELOY has given in the "Onde Electrique" an account of his impressions of a visit to England, Scotland, and Holland, where he has been investigating amateur wireless stations. M. Deloy was particularly impressed with the considerable developments in amateur wireless stations which had taken place in England and Scotland. If we look for the causes of these developments, he says, we find them more particularly in the fact that transmission has been licensed in Great Britain for several years, and that regular telephony transmissions from the Hague and other stations have stimulated interest. Furthermore, the establishment of regular broadcasting service in various towns in Great Britain has attracted considerable public attention. This development is beneficial all round; the manufacturing and commercial community profit by it, and in consequence amateurs are able to obtain suitable parts for assembling their own apparatus readily and cheaply; all this is a considerable help to progress.

"In general, I have noticed," adds M. Deloy, "that the British amateurs take much more pains over their sets than we commonly do here. In addition, they are favoured by

the latitude of their country, and the scarcity of strays and atmospheric disturbances surprised me very much.

"High-frequency amplification on short wavelengths seems to give excellent results, and to be much less difficult than has commonly been supposed in France; we have still much to learn in this direction.

"The British amateurs regulate the heating-current of their valve filaments with great precision by means of rheostats. This appears to be very good practice, and enables them to obtain the maximum sensitivity from their valves by accurate regulation of the applied E.M.F."

In Holland, M. Deloy studied the receiving apparatus made by the Nederlandsche Radio Industrie, which is of special construction. This apparatus generally includes a H.F. amplifier, detector, and L.F. amplifier, all the valves being Philipps. The windings of the coils are made on a special principle, and the greatest care is taken to secure maximum sensitiveness of the apparatus.

The only fault that M. Deloy has found with this apparatus is that it is too dear for the French market, owing to the adverse rate of exchange.

A NOTE ON THE USE OF LOUD-SPEAKERS

Many demonstrations, both public and private, are completely spoiled by the misuse of loud-speakers. In this note the author gives some valuable advice on how to avoid such trouble.

THE "big noise" in wireless is becoming too commonly sought after nowadays. It may be all very well for the possessor of a set who is never satisfied unless he is filling his home with clamant reproduction from his loud-speaker—regardless, of course, of sweetness of tone and sonority—but if the same individual conducts public demonstrations in the same way, the offence becomes nothing less than sheer abuse of the science, and the people who listen to it would probably be far more pleased had they listened-in on a simple crystal set. The limits of the set in use should be fairly recognised; it is bad practice to strain the installation by unduly high plate voltages, high filament temperatures, and tight coupling. That way lies trouble other than distortion, for the lives of the valves may be considerably shortened. These points should be borne in mind, particularly in the reception of broadcasting, and if really large audiences are to be entertained the best method undoubtedly is the use of efficient detecting and amplifying apparatus together with a good power amplifier and several loud-speakers connected in parallel. A loud-speaker, it should be remembered, is capable of giving clear reproduction only up to a point. Beyond that, when the volume

of sound is too heavy, distortion plays havoc. With several loud speakers, however, the desired volume may be obtained without loss of clarity, but one must be careful to have them placed so as not to produce conflicting echoes. If possible the acoustics of the room in which the demonstration is to be made should be taken into consideration. At a demonstration recently in which two loud-speakers were used, set facing each other from opposite sides of the room, a weird effect was introduced by the sound waves from each meeting in the middle and creating a peculiar echo. It was eliminated by putting the loud-speakers in close proximity to each other and facing in the same direction.

If every public demonstration of wireless was conducted on proper lines, we should very quickly hear the last of the similarity of wireless to the gramophone. Under the right conditions speech by wireless is very much more accurate than by gramophone, while the music of practically every instrument can, by its means, be reproduced with its true qualities and features preserved to an extent which most people would describe as perfect. And that has never been done yet by gramophone.

L. B. P.

GLASS ENCLOSED DETECTORS.

HAVE you noticed how there has been a sudden boom in enclosed crystal detectors? A few months ago practically all the crystal detectors sold were of the open variety. Now you find every shop selling little detectors in which the crystal and the cat-whisker are enclosed in a small glass cylinder with caps at each end to keep out the dust. Such detectors look very neat and are mechanically an easy job to make. Of course it is advantageous to keep the dust away from the crystal and this probably accounts for the popularity of this type of stand. Incidentally the glass-enclosed detector will often "give away"

its owner, for an examination of the lower part of the little cylinder frequently shows the accumulation of debris due to constant scratching of the crystal face! Of course a properly adjusted crystal detector will not shed the dust in this fashion, and the presence of the debris is a clear proof that the owner of the set does not know how to adjust his detector properly. Next time you visit a friend who possesses one of these detectors look and see if there is any crystal dust there. Very likely the worst offenders will proudly show clean glasses as they will have read this note before you reach the house! P. W. H.

A NOVEL THREE-COIL STAND.

By R. W. HALLOWS, M.A.

(Staff Editor).

This coil holder has several novel and desirable features not generally found in commercial types.

THOUGH I have used at various times a great many of the two and three-coil stands now on the market, I have never come across one that was all that could be desired. The worst are those in which the movement of the coils is effected by means of toothed pinions. The gears very soon develop a good deal of backlash and the bearings tend to wobble; hence, when the handles are moved the coils travel in a jerky way, which makes fine tuning a matter of extreme difficulty.

Another bad fault found in holders of certain designs is that the moving coils are mounted on spindles which are supported at their upper ends by a brass plate. Stands of this type frequently break down in use through the occurrence of a short circuit through the plate.

But the quarrels that I have with every pattern save the Igranic stand for gimbal-mounted coils, and the Gambrell holder, is that they do not permit sufficiently small adjustments of the coupling to be made. In most makes the coils are mounted upon pivots and the only adjustment that one can make is to increase or decrease the angle between them. This is all very well if they are fairly close coupled, but after an angle of about 45 degrees is reached the tiniest movement of the handle makes a very big difference in the degree of coupling.

There are coil stands which permit of a straightaway movement, the coils being mounted upon holders which travel on pairs of brass rods. This is quite good, but unless a turning movement is also possible, one cannot make those tiny adjustments that are often needed on a crowded wavelength in order to bring in a desired signal and banish others.

What is required in a coil-holder is a double movement. The Igranic and Gambrell stands already referred to provide this, for besides being able to vary the angle between the coils one can also turn each upon its axis in order to make fine adjustments. After a long series of experiments with all kinds of designs I am very much in favour of a pattern which

makes use of a straightaway instead of an angular movement, and at the same time allows each of the travelling coils to be given an independent swinging adjustment.

The coil-holder about to be described was made up more than a year ago, and it has proved satisfactory in every way. There are no mechanical parts to wear out, and the adjustments are so fine that one can get the very best out of the set with it. A glance at the photograph will show that it is simplicity

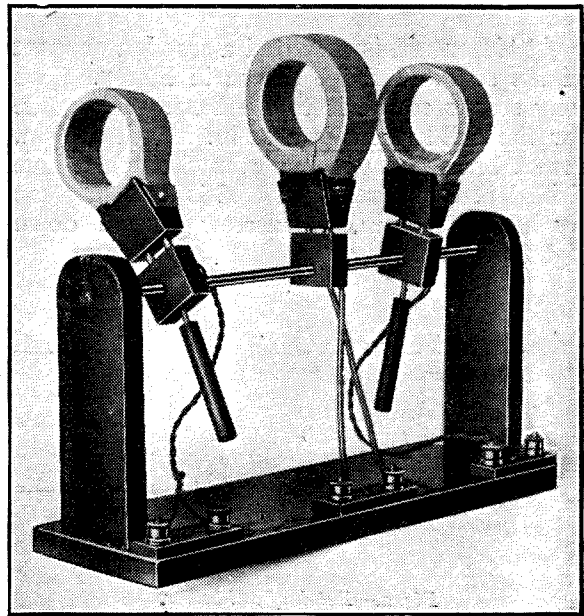

The finished coil holder.

itself. A brass rod, supported between two wooden end-pieces, is provided with three coil-holders, the middle one fixed, the other two capable of being moved inwards or outwards along the rod. Besides its motion towards or away from the fixed coil, each of these has also a circular movement, the rod being the pivot upon which they turn, and the handles acting as set-screws to keep them fixed in the position which has been found most suitable.

The base is a piece of wood—hard wood preferably, though this affects merely the appearance of the finished stand and makes no difference to its efficiency—measuring 12 in. by 4 in. by $\frac{3}{4}$ in. or 1 in. thick.

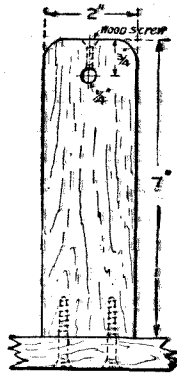

Fig. 1.—End piece.

At either end is mounted a wooden support of the size and shape shown in Fig. 1. Two long screws secure it to the base. The guide for the coil-holders is a 12 in. length of $\frac{1}{4}$ in. round brass rod which passes through a hole drilled in each end-piece, and is held in place by having a $\frac{3}{4}$ in. woodscrew turned down tightly upon it.

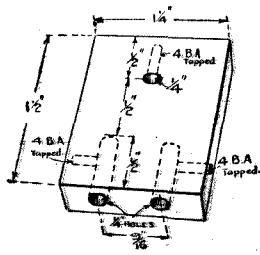

Fig. 2.—Detail of coil-holder.

Fig. 2 gives details of the coil-holders themselves. Each is made from a piece of $\frac{1}{2}$ in. ebonite measuring $1\frac{1}{4}$ in. by $1\frac{1}{2}$ in. In the front edge are drilled two $\frac{1}{4}$ in. holes 9.16 in. apart: these are for the plug and socket. Plugs and sockets may be purchased from advertisers in MODERN WIRELESS at 2d. a pair. Their shanks must be shortened with the hacksaw so that they are half an inch or a little less in length. As they are a driving fit for a $\frac{1}{4}$ in. hole, they will fit very tightly into the edge of the holder.

When they are in place a 4 B.A. tapping hole is drilled as shown in each side of the holder, and right into the brass of plug and socket. These holes are tapped and provided with 4 B.A. round-headed screws long enough to make good contact with the brass. Half an inch beyond the ends of plug and socket a $\frac{1}{4}$ in. hole is drilled through the holder. This is for the guide rod to pass through. In the edge opposite that in which the holes for plug and socket were made a 4 B.A. hole is drilled and tapped, running into the $\frac{1}{4}$ in. hole. This, in the case of the fixed coil, is for a countersunk set-screw which keeps the holder in place upon the rod. In the other two it is for the threaded rod, which is fixed into the extension handles.

These handles are made of $\frac{1}{2}$ in. round ebonite rod. Two and a half inches is a convenient length for them, but they may be made longer if the effects of body capacity are noticeable when the hand approaches the tuning stand. In one end of each a 4 B.A. hole is drilled and tapped. Into this is inserted

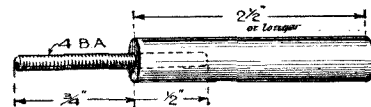

Fig. 3.—Extension handle.

a $1\frac{1}{4}$ in. length of screwed rod, which is screwed tightly home. If the hole is a rather easy fit and the rod is found to be liable to work loose a 6 B.A. countersunk screw may be used as a set-screw to keep it in place; as a rule, however, this will not be found necessary.

The holders having been placed upon it, the guide rod is placed in position between the end supports and fixed by means of the woodscrews previously referred to. We must next mount three pairs of terminals upon the base. The simplest and most satisfactory way of doing this is seen in Fig. 4. For each pair we cut out a piece of $\frac{1}{4}$ in. ebonite measuring $2\frac{1}{2}$ in. by $\frac{3}{4}$ in. In this are drilled four 4 B.A. clearance holes, two for the shanks of the terminals and two for the woodscrews used to fix the block to the base.

Before inserting the terminals screw each block down to the base; then with the point of the scribe mark the exact centre of each of the terminal holes. Take the block off again and with brace and bit make a deepish

recess to clear the shanks of the terminals and their nuts. The terminals may now be mounted upon the blocks, and the latter screwed down to the base. If the recesses made in the wood are properly centred and of sufficient diameter and depth, the terminals will not touch the wood, and insulation will be as good as if the entire base were made of ebonite.

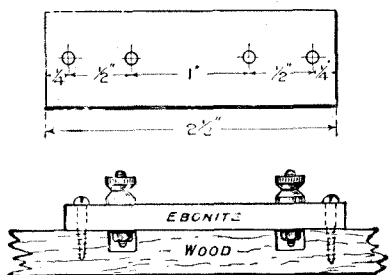

Fig. 4.—Terminals on ebonite block and plan of block.

The fixed coil is connected to the middle pair of terminals by means of systoflex covered copper wires. The moving coils are wired to the other two pairs by lengths of good, well insulated "flex."

The holder is now complete. Let us see what it has cost to make. The base board plus end pieces will probably be made from some odd pieces of oak, teak or mahogany found in the wood box of the workshop. But even if they have to be bought, their cost will not run to more than ninepence. The other components required we may tabulate as follows:—

| | s. | d. |
|------------------------------------|----|----|
| 3 plugs and 3 sockets | 0 | 6 |
| 12 in. length of 1/4 in. brass rod | 0 | 4 |
| Ebonite for coil-holders | 1 | 0 |
| Ebonite rod for handles | 0 | 6 |
| Ebonite for terminal blocks | 0 | 3 |
| 6 terminals | 0 | 9 |
| 4 B.A. screwed rod, screws, etc. | 0 | 4 |
| Flex wire | 0 | 1 |
| Total | 3 | 9 |

If we add 9d. for the base and the end pieces the entire cost works out at only 4s. 6d.—and surely no three-coil tuning stand could be made for much less than this! Nor is the time needed excessive. If one works in quite a leisurely way the job can be done in three hours or less, all parts being well finished up. As the tools required are only a brace with a

3/8 in. bit, a breast drill with 1/4 in., and 4 B.A. clearance and tapping drills, a 4 B.A. tap, a hacksaw, a wood plane, a wood saw, a screw-driver, and a chisel, there are few amateur workshops in which it cannot be undertaken with the greatest ease.

In use the tuning stand will be found to be delightfully simple to handle. The middle (fixed) coil is the secondary, one of the moving coils being the primary. On broadcast wavelengths the third coil cannot be used as the reaction inductance, for it is very rightly not permitted to couple it even to the secondary. When, however, one is working either upon foreign telephonic transmissions or upon the greater wavelengths the reaction coil may be fitted into the remaining coil-holder.

When tuning, the handle of the secondary is grasped in one hand and given a slight anti-clockwise turn. This loosens the screwed rod, which was acting as a set-screw and holding the coil fixed, and allows it to be moved inwards or outwards along the rod. As soon as signals have been tuned to their maximum strength by the straightaway movement, the coil is pivoted gently backwards or forwards until the best adjustment is found. The tiniest clockwise turn of the handle then fixes it firmly in position. The reaction coil is dealt with in the same way.

As one is not depending upon any mechanical contrivances tuning becomes a very simple matter, for there are few appliances so delicate or so sensitive as the human hand. Curiously enough there are "hands" in wireless just as there are in riding or driving. The beginner is clumsy at first when he starts to make adjustments, but the expert gets the "feel" of a tuner very quickly and can do what he likes with it.

The three-coil stand described will be found to be extremely selective on account of the double movement that can be imparted to the sliding coils. The advantages of this will become particularly apparent if it is tested on such a crowded band as that to be found just beyond 12,000 metres. The straightaway movement of the coils brings in a perfect babel of signals; but as soon as the primary and reaction inductances are pivoted slightly, some signals gain in strength whilst others grow weaker and weaker. With careful adjustment a desired signal may be picked out from the general medley and tuned in to the exclusion of the rest.



SPECIAL NOTE.—All apparatus described in this section has been tested by our expert, and readers can therefore rely fully on the opinions given.

A New Loud-Speaker

Messrs. The Telephone Manufacturing Co., Ltd., have submitted for practical test one of their "True Music" loud-speakers. This is of the tall trumpet type (it stands over two feet high), on a substantial base, which latter houses the high-resistance telephone receiver, etc., of approximately conventional type, but on a large scale, with a large, powerful horseshoe magnet; laminated pole-pieces; a large diameter stalloy diaphragm, and a mechanism of strong, rugged design for the adjustment of the magnets, this being controlled by a convenient milled-head screw which projects from the base. The copper trumpet and the rest of the instrument are finished in a dull black, an ample length of twin flex being supplied for connecting to the set. On practical trial, the adjustment to maximum sensitiveness was found quite easily, the sensitiveness is indicated by the fact that 2LO was distinctly audible with a crystal tuner of by no means the best possible design with a P.M.G. aerial, and at a distance of a dozen miles, several feet away from the loud-speaker in a quiet room. On noisy valve reception the power compared favourably with that of other types; on the ST100, it carried well in the open air in competition with daylight traffic noises, and

showed little distortion: best with a .002 μ F condenser shunted across it.

The workmanship and finish were good. While the matter of appearance is largely one of per-

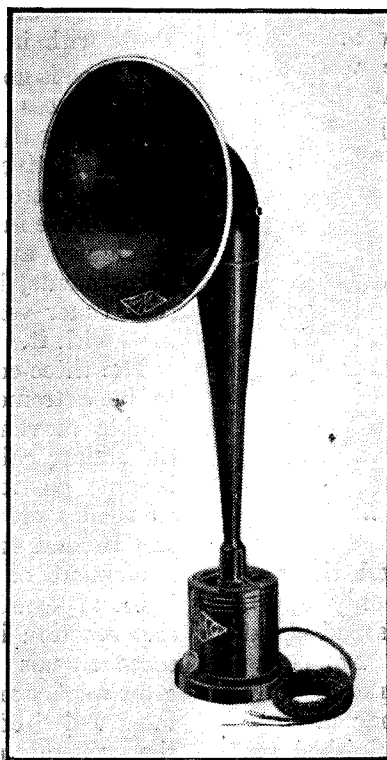

The T.M.C. "Truemusic" Loud-speaker

sonal taste and prejudice, it appears to the writer that in the case of an instrument which in style and price is calculated to appeal to a refined public who will appreciate harmony and elegance in appearance as well as acoustical perfection—with due regard to the necessity of ample size to obtain good power—it might be possible to soften the somewhat stark and harsh outline of the present model, for everyday and personal intimate use outside of the wireless den.

A Low-Frequency Intervalve Transformer

From Messrs. Ferranti, Ltd., we have received for test a low-frequency intervalve transformer of substantial size (4 in. by 2 3/4 in. by 2 in.) and careful design. It is indeed a refreshing change, and one calculated to inspire much confidence in the products of the makers, when so complete technical details as to design and testings are communicated in connection with a new instrument as was the case with this Ferranti transformer. Not merely the (largely irrelevant) resistance-ratio is given, but the sizes of the wire, turn numbers, etc., are freely revealed. The comprehensive factory tests, together with the generous gauge of wire used should be a good assurance against breakdown in use: the transformer is guaranteed by the makers on 130 volts, and 12

milliamperes plate current. The turn ratio is given as 1.4.

The transformer is of prepossessing appearance, with the high-class finish one might expect from a firm of their reputation. The provision of a copper soldering-tag for earthing the frame is an example of the thoughtfulness of design.

On practical test, satisfactory results were obtained, in comparison with well-known makes of

of being completed through the hard steel of the permanent magnets. It is claimed that this results in louder and less distorted speech.

Certainly on practical test on crystal reception, very good and loud signals were obtained, after properly adjusting the magnets for optimum sensitiveness. The phones compared very favourably with good English and two ex-

ceedingly sensitive Continental makes of about the same resistance, which is 4000 ohms for these phones. The results on telephony were far superior to those obtained, alas! on many of the English-made phones commonly supplied with B.B.C. sets.

These phones are fairly light; the headpiece is readily adjusted

and removed; the leather-covered band and sliding adjustment does not catch in ladies' hair, we are informed after trial by the feminine experts; and they are of a comfortable type when once the band is set right for the size of one's head. The magnet adjustment is easy, and it stays set; the finish and general appearance unexceptionable; while the cords supplied are of generous length.

high efficiency; with good magnifying power and without noticeable distortion. The fairly substantial core used was appreciated in this connection. On 130 volts there were no parasitic noises; very fine loud-speaking was obtained with the ST100 with this transformer in either of the two positions in that circuit: when in the first grid circuit the secondary was best shunted by a .00025 μ F condenser. It is a handsome, effective, and beautifully finished instrument.

A Telephone Head-Set

An "ultra-adjustable" head-set with adjustable magnets and laminated pole-pieces with what is claimed to be a new magnetic principle incorporated, has been submitted for trial by this magazine. They are of Continental manufacture. In these receivers the laminated pole-shoes, on which the bobbins of wire are mounted as usual, are designed and shaped so as to leave only a comparatively narrow air-gap (some two millimetres wide) at the lower end of the bobbin-carrying portion; so that the magnetic circuit for the speech-producing magnetic flux, which is nearly closed at the outer end by the diaphragm, is also all but completed by a short path in iron at the inner end, in place

A B.B.C. Two-valve Receiver

Messrs. C. F. Elwell, Ltd., have afforded us an opportunity of making a thorough test of the "Aristophone," Type No. 56, an imposing long-range receiver, with one high-frequency and one detector valve; and the permissible form of reaction on the interval coupling over the whole wave-length range, which covers not only the British broadcasting wave-lengths, but also the longer waves up to and beyond that of Paris.

The instrument is in the form of a panel-fronted box, which encloses

the valves, etc., and has compartments for both accumulator and high-tension battery; making, except for aerial and earth connections, a complete self-contained receiver. A hinged lid gives access to the interior, and small opal windows are provided for viewing the valves when closed.

A "Coarse Tune" selector switch, by tapped inductance and series-parallel condensers, gives rough tuning; a second handle tunes finely by variometer; and a third "Fine Tune" controls a compact condenser which tunes the anode reactance; while a "Reaction" handle, by means of a barrel-cam switch which is one of the neatest devices we have seen in a commercial set, both picks out one of three combinations of anode-tuning inductances with their reaction-coils in the plate-circuit of the second valve, and also gives by smaller rotational movement the variable reaction. The result is an exceedingly compact tuning device.

On practical test the instrument did not belie the implication of its name; one could sit comfortable in one's arm-chair and by manipulating the four handles go the rounds of London (very loud in phones); Birmingham (readable easily while 2 LO was working); Cardiff; and (by careful tuning in the intervals of local broadcasting) Manchester; then switch over to Eiffel (very clear and enjoyably loud); Paris Radiola (ditto), etc.; Morse, of course, came in very

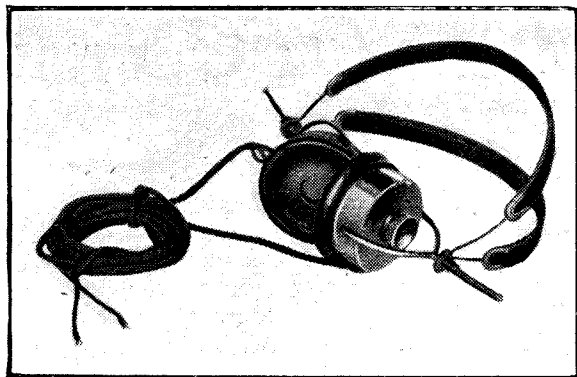

The Ultra-Adjustable Telephone

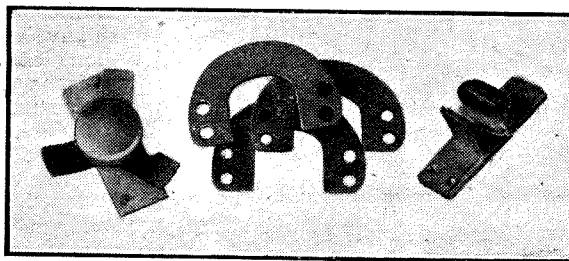

The Ultra-Adjustable Telephone dissected

loud everywhere, long-wave Continental stations being deafening. The calibration chart supplied with the instrument proved fairly accurate, though, of course, the primary tuning must be adjusted to the particular aerial used. The high-frequency amplification was obtained without troublesome oscillation, thanks to a fixed potentiometer incorporated in the instrument.



BASKET COIL FORMERS.

BASKETS are quite the most easily made of all the low-capacity inductances, and they are so useful for wavelengths up to 3,500 metres that the con-

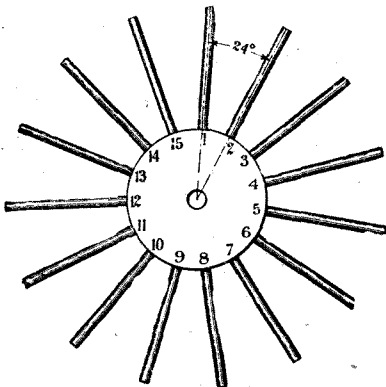

The complete former.

struction of a simple former upon which they can be wound without difficulty will well repay the time and trouble spent.

Draw a circle six inches in diameter on a piece of paper, and within it draw a concentric 2 in. circle. With a circular or semi-circular protractor—even a condenser degree-scale will do at a pinch—make a mark at every twenty-four degrees round its circumference. This will divide the circle into 15 equal parts. Join each mark to the centre, and cut

out the smaller circle with a pair of scissors. This is meant to act as a template.

Paste it on to a circular piece of ebonite 2 in. in diameter and $\frac{3}{8}$ in. thick. Make a mark with the scriber on the edge of the ebonite disc corresponding to every ray drawn from the centre to the circumference of the circle. At each mark drill and tap a $\frac{1}{8}$ in. (Whitworth) hole, $\frac{3}{8}$ in. deep.

Cut off 15 $2\frac{1}{2}$ in. lengths of $\frac{3}{8}$ in. round brass rod, put a $\frac{1}{8}$ in. Whitworth thread on to one end of each. If you have no die you can get this job done at a bicycle repairing shop for a trifling sum. Screw the spokes in. The former is now ready for use.

To wind a basket coil, take a turn of the wire round the spoke at the top, hold the former in the left hand, and with the right weave the wire in and out of the spokes, taking care not to miss one.

When as many turns as are needed have been put on, tie the turns between the spokes so that the coil will not fall apart when taken off, and unscrew the spokes. An alternative method is to dip the coil in molten paraffin wax. The coil will generally come away quite easily, but if it does not, unwind the first turn by pulling on the starting end of the wire.

R. W. H.

PROTECTED STAPLES.

WHENEVER insulated wire is secured to woodwork by means of staples these should be protected in some way, otherwise when they are driven home it is almost certain that they will cut through the covering and earth the wire, partially at any rate.

A simple and perfectly satisfactory method is shown in the

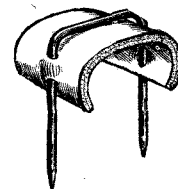

A protected staple.

drawing. A little piece is cut from an old inner tube and holes are pierced in it with a bradawl to allow it to be passed on to the legs of the staple as shown. If no rubber is available thick cloth may be used.

A better job still is made by employing thin sheet fibre for the purpose. This, besides looking very neat, protects the wire most effectively from harm. Both rubber and fibre act as insulators even if the covering of the wire is accidentally cut by driving the staples too tightly home, or by subsequent ill usage.

R. W. H.

WING NUTS FOR THE LEAD-IN

VERY useful wing nuts for attaching the lead-in and earth lead to their respective connections can be made from those round flat 2 B.A. nuts about the diameter of a halfpenny, but two or three times as thick, which can be bought for a penny a piece from advertisers in MODERN WIRELESS.

All that is necessary is to drill and tap a pair of 4 B.A. holes in the

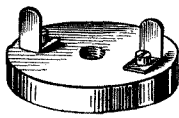

The finished wing nut.

surface of the nut and to fix on by means of screws a couple of L-shaped pieces cut with the tin shears from sheet brass. The drawing makes this plain.

Owing to their large surface these nuts provide an excellent means of attaching the lead-in to the rod which runs through the insulating tube from the outer wall of the house to the room where the set is. The little wings enable them to be tightened hard down, and to be released quite easily when it is desired to detach the lead-in.

R. W. H.

HOW TO MAKE RIGHT-ANGLED BRACKETS IN BRASS.

It is often necessary when building apparatus at home to make a right-angled brass bracket of fairly heavy material to support intervalve transformers, plug-sockets and other components. The simplest way is to take a strip of brass of the required thickness, and with the edge of a square file, file a notch across the strip with the edge of the square file until the brass is thin enough to be bent fairly easily. Now bend the brass so that the notch closes up, and then solder it to make it as strong as necessary.

A REVOLVING TELEPHONE TERMINAL BOARD

IT has been found that when a sharp jerk has accidentally been given to the headphone flex, the end-pieces which are fixed in the terminals are either bent as a result, or torn away from the flex itself and have to be replaced. A simple device to obviate this trouble is illustrated in the diagram herewith. Firstly the terminals are screwed into a board of suitable dimensions, and a hole is then drilled exactly in the centre of the board to clear the centre screw

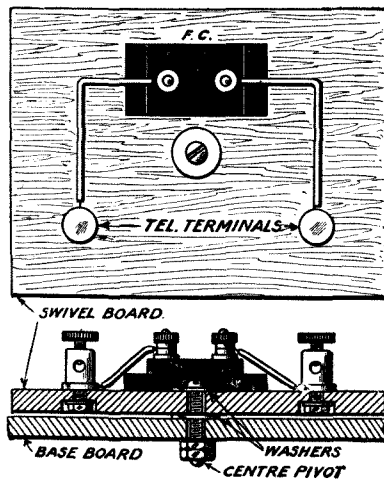

A safety device for the telephone.

which acts as a pivot. This latter is now screwed into the base-board for a sufficient distance to allow the top board to swing round easily, but not too loosely. The fixed condenser which is usually placed between the phones may be attached to the same board if desired, but in any case sufficient play should be given to the connecting wires to allow a circular movement of the board. It will be seen that a sudden tug on the telephone cords will swing the board round so that the pull will be a straight one which will be less likely to damage the cord tips and flex.

H. B.

A HINT FOR LISTENERS-IN

THE following is a useful little hint for amateurs listening-in with the old type single-layer solenoid coil as A.T.I. With such coils signals are often considerably weakened from dead-end effects. These may easily be eliminated in the following manner, without going to the trouble of rewinding the coil in sections. The method may also be used as a test to determine whether dead-end effects are present.

Tune in the ordinary way, and press the thumb against the tapping studs, trying them all the way round. One will perhaps be found which, when separately earthed in the above manner, will double or considerably increase signal strength. This proves the presence of dead-end effect in the coil.

Obtain a small ebonite knob, and fix it to the tuning knob of the A.T.I. by means of a single screw, in such a manner that it will rotate easily. The screw must not come into contact with the spindle of the switch arm. Fix to this knob a switch arm of springy brass, bent to make good contact on the studs. From the point of attachment of this arm to the knob a lead of flexible wire should be taken to a separate earth (even holding the bare end in the hand will

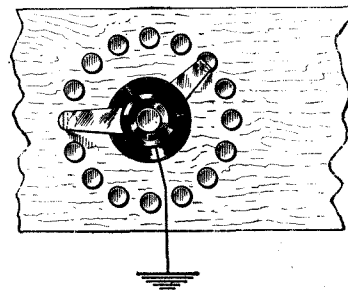
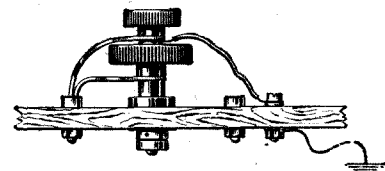

A useful switch to reduce "dead-end" effects.

do). Stations should now be tuned in as usual, and the second tapping varied until the best effect is obtained. This method of switching enables any section of the coil to be used at will, entirely eliminat-

ing all dead-end effect from the unused portion. It is especially useful in the case of telephony, and often brings in Morse stations quite loudly which before were practically inaudible.

prepare an extension cord for the loud-speaker, so that it can, when necessary, be taken into another room or into the garden. A suitable method of making this extension cord is to fit plugs and sockets of the type shown in the illustration to a cord which can then very quickly be placed between the telephone transformer and the loud-speaker plug.

P. W. H.

A USEFUL TELEPHONE TRANSFORMER BOX

MANY experimenters find it convenient to keep the telephone transformer separate from their set, so that when needs arise they can use either high or low resistance telephones or loud-speakers.

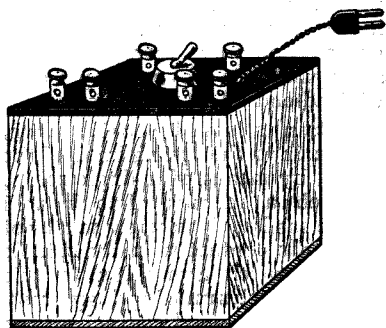

The finished box.

The writer has found it convenient to mount his telephone transformer in a special box, fitted as shown in the two illustrations. It will be seen from the first illustration that the top of the box consists of an ebonite panel on which are fixed six terminals and a tumbler switch, such as can be bought from any motor accessory dealer. The two terminals at the rear are connected to the high resistance side of the telephone transformer, while those in front are connected in parallel to the low resistance side of the transformer.

In addition to these terminals, there are two flexible leads which terminate in a plug which can be fitted into a corresponding

socket connected to the loud-speaker. The wiring is so arranged that when the switch is "on," the loud-speaker is connected across the high resistance side of the transformer. Thus, when listening on the telephones on low resistance side, when it is judged that the signals are of suitable strength for a loud-speaker, the tumbler switch can be pulled over and the high-resistance loud-speaker is immediately in circuit and operates. The telephones can then be withdrawn from their terminals.

The fact that the high resistance side of the transformer is then in parallel with the loud-speaker does not seem to make any difference in signal strength or quality.

Several modifications of this wiring can be made to suit the individual needs of the experimenter. For example, instead of the two pairs of front terminals being both on the low resistance side, one can be on the high resistance side and one on the low, so that either high or low resistance telephones can be connected to the terminals.

In this connection it will be found extremely convenient to

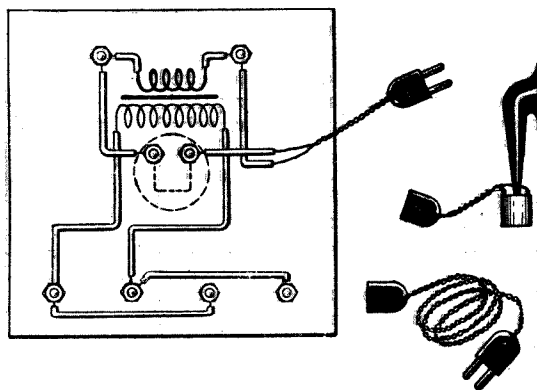

Wiring and connection of loud-speaker.

NOVEL INSULATING BUSHES.

THE method of insulating terminals and the like, where wood is used for a panel in place of ebonite, on the score of expense, is usually carried out by inserting ebonite bushes.

The writer has used with every satisfaction bushes formed as shown in sketch: these consist of a short piece of systoflex of a bore large enough to go over terminal, and long enough to extend through the thickness of the wood panel, and above and below the panel, mica washers are used to insulate the metal from the wood; these were obtained from

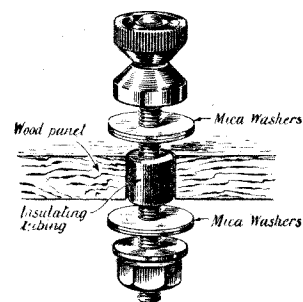

The bushes in position.

an old mica sparking plug which is made by threading layers of mica on the centre spindle and compressing them with a nut, and is afterwards turned down in the lathe to the required diameter.

One of these plugs will provide a large number of washers.

The method will be found to give a neat finish to the panel and is a cheap method of making an efficient job.

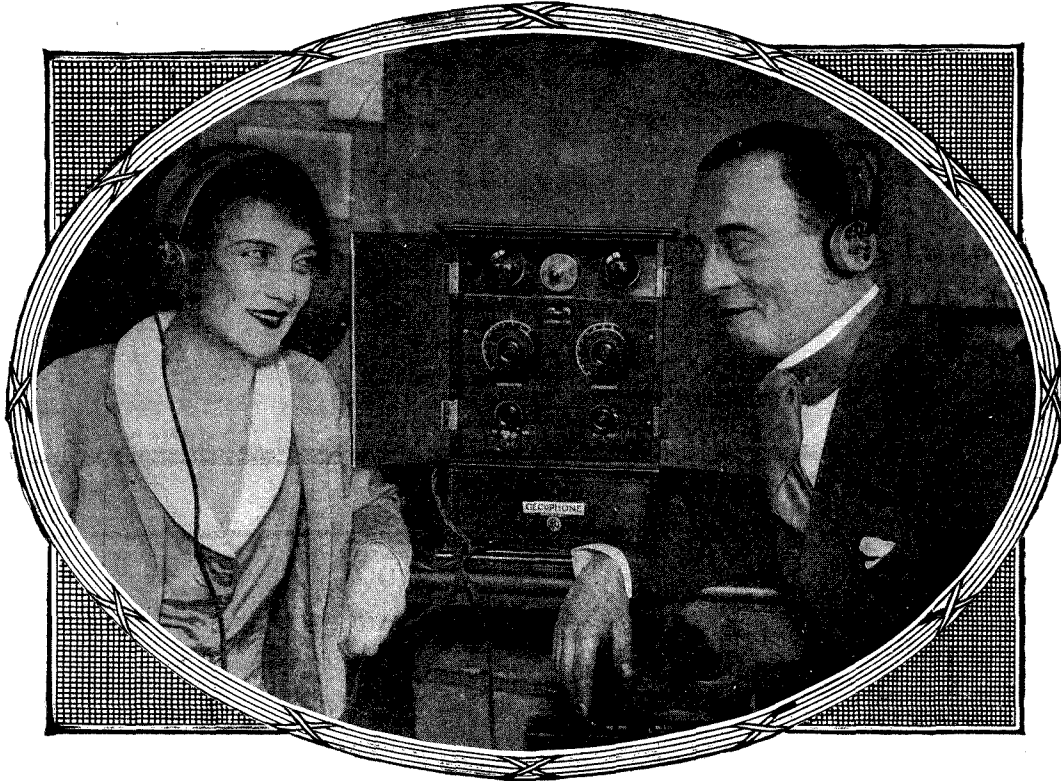

Mr. Leslie Henson and Miss Dorothy Dickson, Principals in "The Cabaret Girl" at the Winter Garden Theatre, find time between the acts to indulge in the pleasures of "Listening-in" on a Two-Valve GECophone Set.

The Pleasures of Broadcasting.

HOWEVER remotely situated you may be, with a GECophone you are in touch with the British Broadcasting Stations, and can enjoy to the full evenings of keen pleasure and profitable interest.

An Aberdeen user writes: "The efficiency of the GECophone Set is remarkable, and the fine finish and workmanship of the whole apparatus is specially noticeable. The G.E.C. are to be congratulated on their production, both on account of workmanship and moderate price."

The triumph of the GECophone is solely attributable to the painstaking research and vast manufacturing experience of its makers—The General Electric Co., Ltd.—pioneers in the fields of Wireless and Telephony.

GECophone CRYSTAL SET No. 1.

Complete with one set double head-phones. Approx. range 25 miles. Price complete **£5 : 10**

GECophone CRYSTAL SET No. 2.

Complete with one set double head-phones. Approx. range 30 miles. Price complete **£9 : 15**

GECophone 2-VALVE SET.

Complete with valves, batteries and one set double head-phones. Approx range 100 miles. Price complete **£25**

GECOPHONE

"LISTENING-IN" SETS.

Sold by principal Electricians, Stores, Wireless and Musical Dealers.

Sole Selling Agents for the Music Traders in Great Britain and Ireland: Columbia Graphophone Co., Ltd., 102-108 Clerkenwell Road, E.C. (Manufacturers and Wholesale only) **THE GENERAL ELECTRIC Co., Ltd.**, Head Office: Magnet House, Kingsway, London.

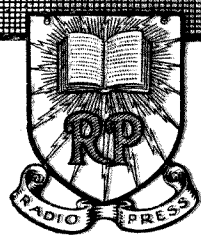
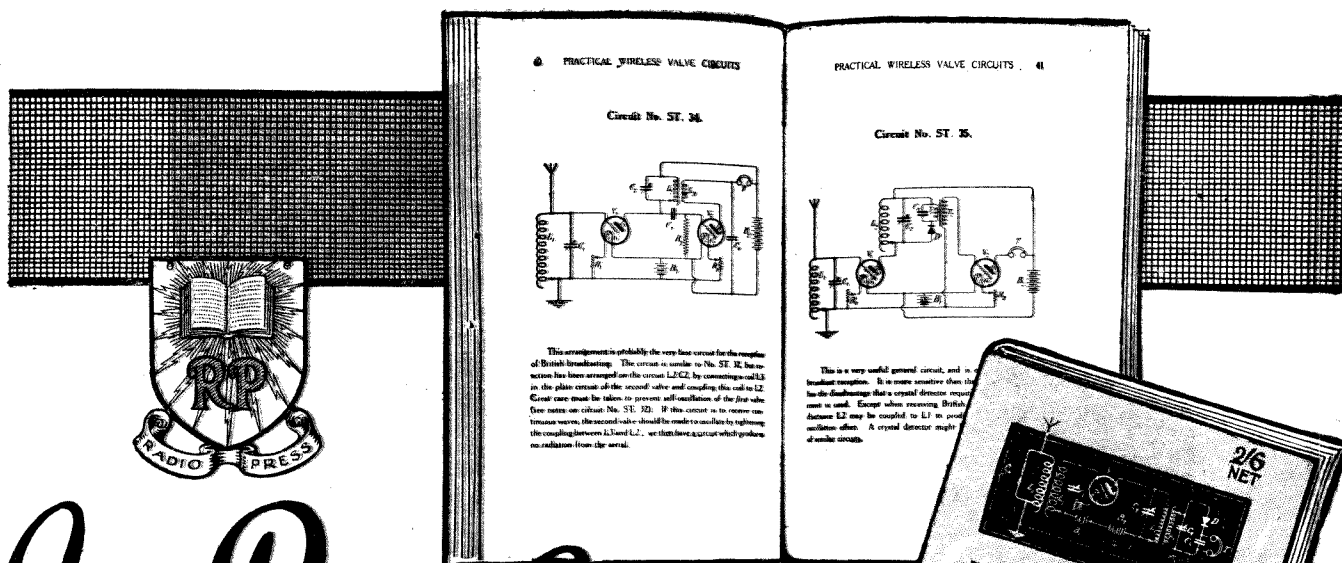

No Paper Circuits

—like S.T. 100, every one the result of practical tests

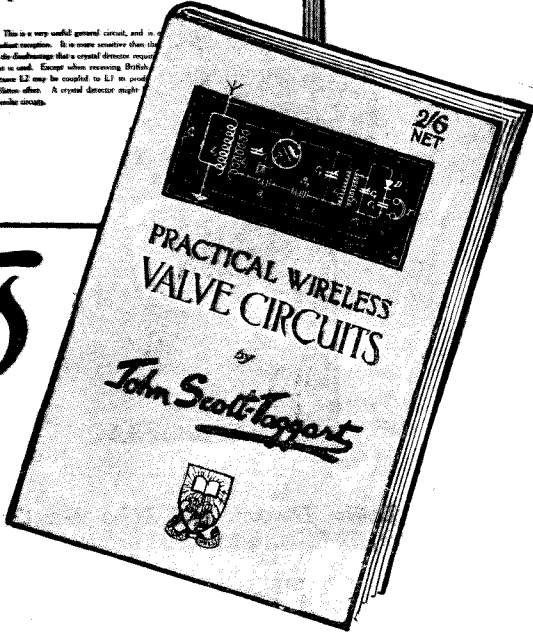

WHEN building your Set you will want to be confident that the circuit is the best possible. Many circuits often recommended are only "theoretical" circuits, and when the user comes up against the hard school of actual practice he is apt to get disappointing results.

If you get a Book like *Practical Wireless Valve Circuits*, you are guarded against this. Every circuit—and there are over 60 of them—has been actually tested under working conditions, and where necessary typical valves for fixed condensers and resistances are given.

Many circuits are quite new, and all are the result of many years' Radio research work by John Scott-Taggart, F.Inst.P. (Editor-in-chief of *Modern Wireless* and *Wireless Weekly*).

Buy a copy to-day—keep it for reference, you will find it a continual help.

Practical Wireless Valve Circuits

CONTENTS.

1. Crystal Detector Circuits.
2. Single-Valve Circuits.
3. Two-Valve Circuits.
4. Three-Valve Circuits.
5. Four-Valve Circuits.
6. Five-Valve Circuits.
7. Local Oscillators for Heterodyne Reception of C.W.
8. Valve Transmitter and Radiophone Circuits

2/6

RADIO PRESS, LTD.,
Devereux Court, Strand, W.C.2

From all Booksellers or 2/8 post free from the Publishers.

AUXILIARY RESISTANCES FOR DULL EMITTERS

WHEN one is using the low temperature valves that are now becoming so deservedly popular, it is often rather a difficult matter to reduce the E.M.F. of a 6-volt accumulator

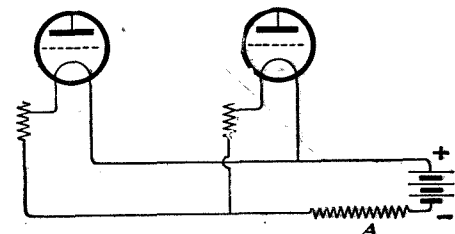

Fig. 1.—The wrong method of using the auxiliary resistance.

to a suitable value for the time being. If the three cells are connected by movable metal strips, these may be disconnected and replaced so that the cells are wired in parallel instead of in series. This is all very well so long as one is going to use dull emitters and nothing else, but it is not very satisfactory if sometimes high temperature and sometimes low temperature valves are employed. One wants to be able to change from one to the other without

The best way is to make a small fixed resistance for each valve so arranged that it can be plugged when wanted into a pair of valve legs wired in series with the rheostat. The wiring is shown in Fig. 1. If high temperature valves are in use the plug-in resistances are removed and the gap between valve legs is shortened by means of another small "gadget" to be described presently.

Fig. 3 shows the resistance arrangement. It consists of nothing more formidable than a 2-inch length of $\frac{1}{8}$ in. diameter ebonite rod, upon which are wound 2 yards of No. 30 resistance wire. The ebonite rod is secured to supports made of

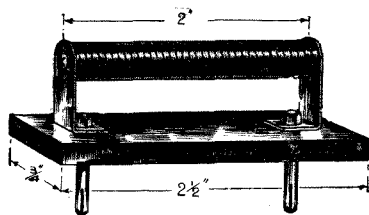

Fig. 3.—A plug-in attachment.

sheet brass by means of a 4 B.A. screw at either end, the ends of the resistance wire being soldered to the supports. These are mounted on a piece of $\frac{1}{4}$ in. ebonite measuring $2\frac{1}{2}$ in. by $\frac{3}{4}$ in., a pair of valve prongs being passed through the ebonite from underneath and through the feet of the brass supports and secured in place by means of nuts.

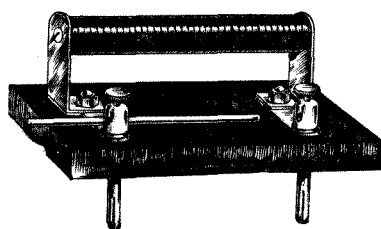

Fig. 4.—A modification of Fig. 3.

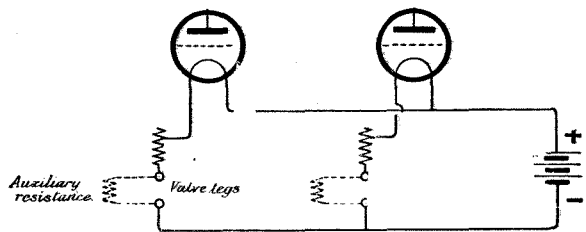

Fig. 2.—The correct way.

difficulty or loss of time, which is impossible if the accumulator connections have to be altered whenever one type of valve or the other is inserted.

The normal 5 or 6 ohm rheostat is of no use at all by itself. Nor can we solve the problem by inserting a series resistance between the battery and the LT-lead as A in Fig. 1. If we try this we shall find that if one's valve filament is turned down the others all brighten and vice versa.

When the resistance is plugged into the valve legs upon the panel an extra 8 ohms are obtained. If this proves to be more than is needed a little of the wire may be stripped off. For short circuiting

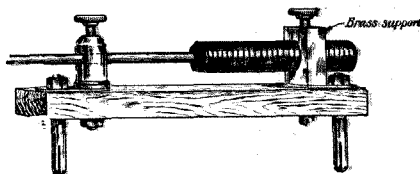
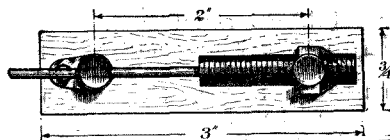

Fig. 5.—The resistance made variable.

purposes when dull emitters are not in use another plug may be made consisting of a strip of ebonite containing two valve pins connected by a piece of sheet brass. Or if desired the arrangement shown in Fig. 4 can be made up. Here two "push-in" terminals, connected by brass strips to the supports, are mounted on the ebonite. A length of $\frac{1}{8}$ in. brass rod serves to short-circuit or throw in the resistance in a moment.

The resistance may also be made roughly variable as shown in Fig. 5. This is a very great advantage if one is trying different types of dull emitters, for the voltage needed varies from 1.1 with the American W.D.-11 to 3 with the M.O. D.E.V. and D.E.Q.

A piece of $\frac{1}{8}$ in. rod is screwed into one end of the rod, the resistance wire being soldered to it. The brass rod slides in the hole of a push-in terminal. The wire-wound ebonite passes through a $\frac{5}{16}$ in. hole drilled in a piece of $\frac{1}{4}$ in. brass. The set-screws of the terminal and of the brass support enable a firm contact to be made. There is no need here for a special short-circuiting device, since if the ebonite former is right pushed to the right until only its last turn is in contact with the brass support the extra resistance is practically eliminated.

Those who make up these handy little resistances should note that each cannot be used to control more than one valve of the D.E.R., or Mullard L.F. Ora B. and C. types, since they require .4 amp a piece, and its current carrying capacity is only about .6 ampere.

R. W. H.

A COLLAPSIBLE
FRAME AERIAL

A FRAME aerial is in many instances used where space is limited. It is not an ornamental article, and cannot therefore be looked on as a piece of furniture. A collapsible frame aerial has several advantages, both from the point of view of appearance and the space it occupies. The Aerial described in this note can be adapted to a table stand, a wall bracket, or may be suspended from the ceiling. In Figs. 1 and 2 the general construction of the frame open and the frame closed are shown. Fig. 3 shows the details of construction. *A* represents the diagonal stays, of which there are four. These are cut from $\frac{3}{8}$ in. square wood, with a $\frac{3}{8}$ in. slot cut each end, and holes drilled to take securing bolts. *B* shows the four spacing

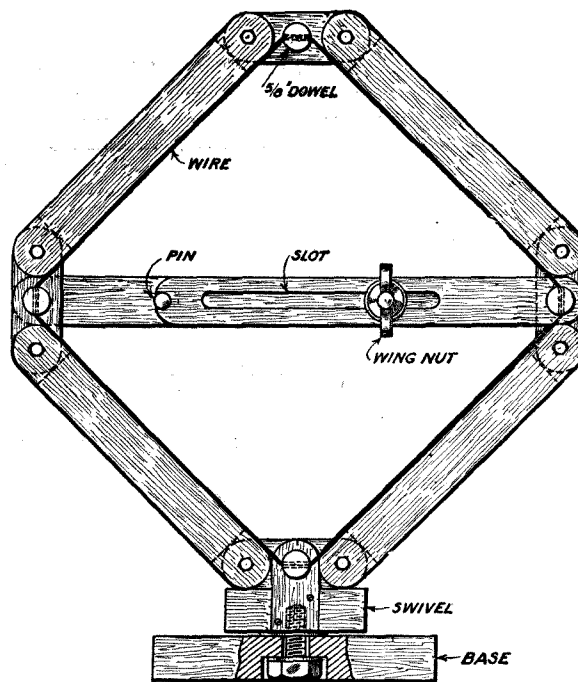

Fig. 1.—The finished frame.

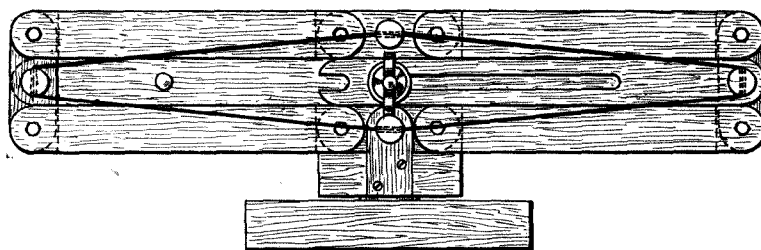

Fig. 2.—Frame aerial closed.

is for this purpose. The wing nut when tightened up locks the frame in both the open and closed positions. The wire working in the holes in the dowels retains the same length in both positions. *E* shows the swivel base which may be adapted with a little ingenuity as a bracket.

H. B.

pieces, which are made from $\frac{3}{8}$ in. and $\frac{1}{2}$ in. wood. The centre hole is drilled to receive a $\frac{3}{8}$ in. dowel, which is, in its turn, drilled to receive the wire. These drillings are made to correspond with the number of turns of wire desired, and should be a running fit for the gauge of wire used. The end holes are drilled to fit into the ends of piece *A*. *C* shows the centre stay, which is drilled one end to receive a $\frac{3}{8}$ in. dowel. The positions of the pin and wing nut can be determined from the open position of the assembled frame, the slot in piece *D* being long enough to operate in the closed position. The piece *D* is slotted to make a running fit on the bolt of the wing nut. The pin is to locate the two stays in a horizontal position when the frame is open. The nick cut in the end of piece *D*

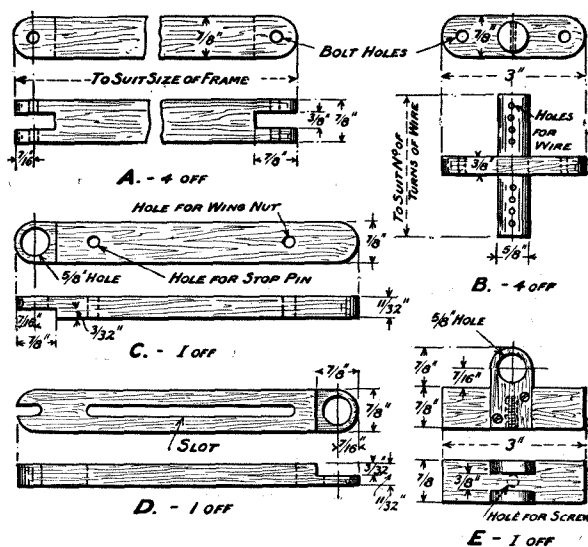

Fig. 3.—Details of construction.

G.R.C. Parts.

I never tell anyone

to buy "G.R.C. parts." My advice to you is "Be satisfied only with the best obtainable and see that the price you pay is no more than a 'quality' product should cost." Sooner or later you will insist on G.R.C. and the longer you look around before deciding the more convinced you will be. Take it from me.

Have you seen my free Book "A Radiophone in Every Home." If not send a post-card for one NOW.



General Radio

- No. 1. G.R.C. 83 : : **Audioformer** 22/6
- No. 2. G.R.C. 71 : : **Variometer** 22/6
- No. 3. G.R.C. 111 : : **Radiophone Plug** 4/-
- No. 4. G.R.C. 113 : : **Radiophone Jack** 2/6
- No. 5. G.R.C. 72 : : **Vario-Coupler** 25/-

No. 1

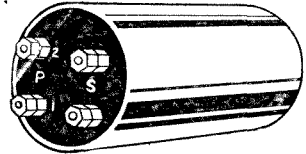

No. 2

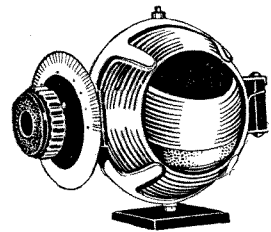

No. 3



No. 4

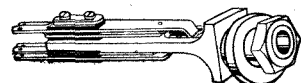

No. 5

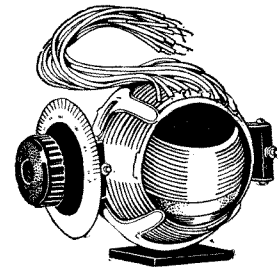

GENERAL RADIO COMPANY LIMITED

TWYFORD ABBEY WORKS, ACTON LANE, HARLESDEN, N.W. 10.

Telephone: Willesden 3955 (3 lines).

SHOWROOMS: 105, Great Portland Street, W.1.

Telegrams: "Milliamp, 'Phone, London."

BRANCHES IN ALL CITIES.



*Result of
15 years'
Experience*

Brandes

WARNING!

Cases having come to our notice of Headsets described as "BRANDES" being offered for sale at less than our fixed price, we hereby decline to accept responsibility for any complaints arising out of such purchases. The genuine BRANDES "MATCHED TONE" HEADSET—guaranteed by the manufacturers—is sold only at

PRICE 32/-

Made in England and bears the B.B.C. Stamp.

CANADIAN BRANDES LTD.,
Walmer House, 296, Regent St., W. 1.

*Telephone: Langham 1525.
Trade Enquiries Invited.*

Matched Tone

TRADE MARK

Radio Headsets



MOUNTING BASKET COILS

By OSWALD J. RANKIN.

AT the present time there is hardly a satisfactory means of mounting and connecting up basket coils. The usual method of mounting them is to slide them over a rod, mounted horizontally on an upright support. This invariably results in displaying a certain degree of "lop-sidedness," which has a very irritating effect on the enthusiast with a "straight eye," not to mention the loss of accuracy in coupling. The connections are, in almost every in-

perhaps is most deserving of the name, and the coil wound on a permanent slotted disc of fibre or cardboard. Either type may be used with the simple holder to be described. In the case of the first-mentioned, it will be necessary to provide an equivalent to the permanent disc of the other type. Two small discs of fibre, or cardboard well-soaked in melted paraffin wax, are clamped one each side of the coil by means of two valve legs, as shown in Fig. 1, the valve legs

and the end of the winding. This is most important.

In the case of the coil with the permanent former, the valve legs are attached direct in a central position, and connected up and labelled in precisely the same way. (See Fig. 1.)

The construction of the holder is a very simple matter, the only materials required being four valve sockets, four terminals, two strips of ebonite, a pair of brass hinges, and a small baseboard. The hinges should first be obtained, and the width of the $\frac{1}{2}$ in. sheet ebonite strips, which are each about 4 in. in length, should be cut equal to the length of the hinges, as indicated in Fig. 2. The small holes drilled through the top of each strip, or pillar as it may

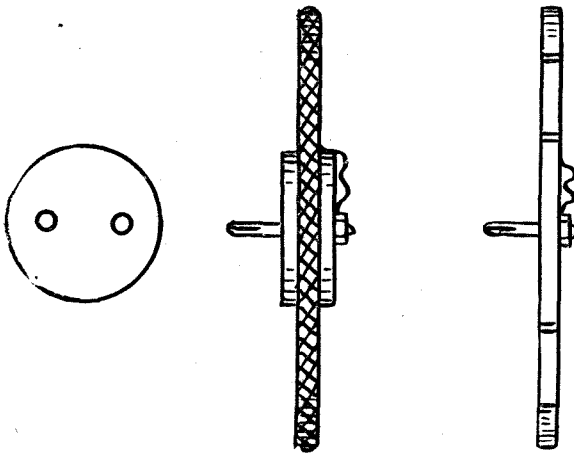

Fig. 1.—Mounting the coils with discs and valve pins.

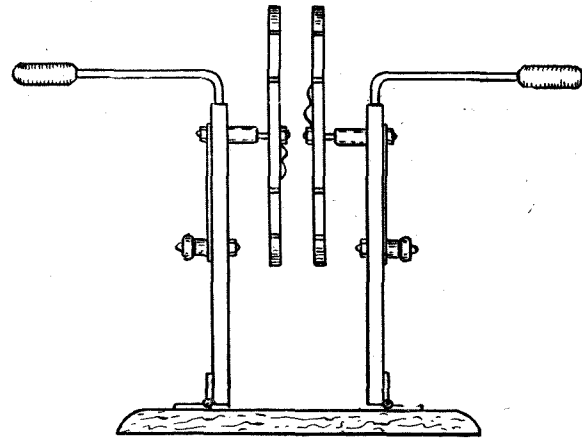

Fig. 3.—The completed instrument.

stance, made by twisting the bared ends of the winding round the end of the connecting wire. This, of course, is very bad form, since such a connection is anything but reliable, and a fracture in the wire, caused

passing through the hole in the centre of the coil. The distance between the valve legs should be standardised; that is, if they are placed $\frac{1}{2}$ in. apart on one coil, those fitted to another coil should

now be termed, are fitted with the valve sockets, which are accurately spaced to engage the valve pins attached to the coils, and the larger holes accommodate the terminals which are connected by means of short strips or links of copper foil to the valve sockets, in the manner shown in Fig. 2.

The free flange of each hinge is now secured to the baseboard, so that the coils, when placed in position, will almost touch each other. The general arrangement of the instrument is indicated in Fig. 3. Small manipulating handles may be included as shown, these, of course, being optional. It will be seen that both coils are movable. If it is desired to confine the adjustments to one coil only, a little solder may be run over the joint of the other hinge, so as to form a rigid angle piece supporting the other pillar. It is an advantage, however, to have both coils movable.

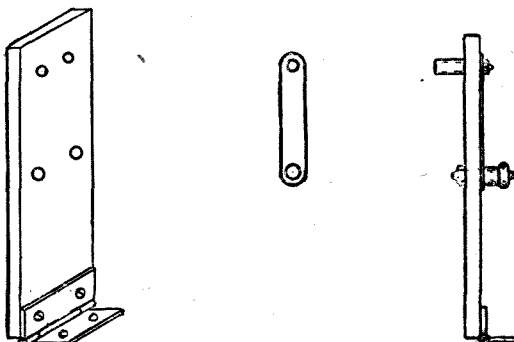

Fig. 2.—How to make the standards.

by excessive twisting, will often occur when one least suspects it.

There are two distinct types of basket coils in common use to-day: the coil which is wound round pins on a detachable former, and which

also be exactly $\frac{1}{2}$ in. apart. The ends of the winding are soldered to the valve legs, which are then marked "IN" and "OUT," or "A" and "B," so that the operator will always know which is the beginning

O. J. R.

AN IMPROVED EXPERIMENTER'S PANEL

IN the ordinary type of experimenter's panel—comprising valve holder, filament resistance and four terminals, all mounted on ebonite—the valve holder is situated on top of the panel and the valve is consequently exposed to the danger of accidental knocks which only too frequently happen when the experimenter is

taining box and the valve is therefore easily accessible.

The box can be first constructed from suitable wood $\frac{3}{8}$ inch thick. The pieces required will be as follows:—
Two side pieces each

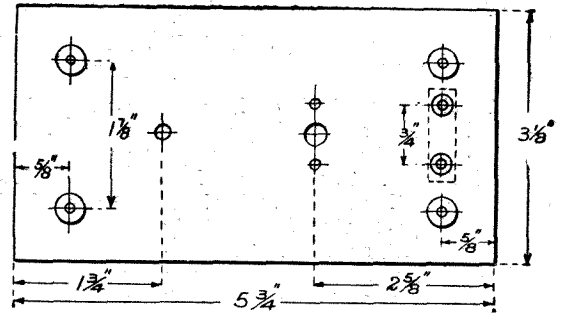

Fig. 3.—Layout of panel top.

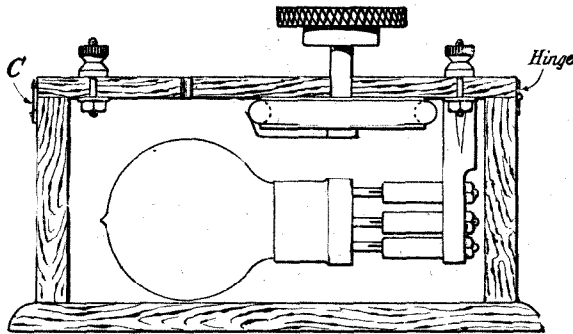

Fig. 1.—The complete instrument.

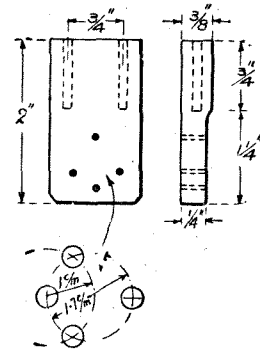

Fig. 4.—Valve holder.

hastily changing connections. The accompanying sketches show a design of panel where the valve is enclosed which is a distinct advantage over the ordinary type.

A sketch of the panel is seen in Figure 1, showing the valve and holder, the resistance and terminals. Figure 2 is a part sectional end view where the valve is not shown. As seen from the sketches, the ebonite top is hinged to the con-

$5\frac{1}{4}$ inch by $2\frac{1}{2}$ inch, two end pieces each $2\frac{1}{2}$ inch by $2\frac{1}{2}$ inch, and the base $6\frac{1}{4}$ inch by 3 inch.

A piece of $\frac{1}{4}$ inch thick ebonite is cut and filed to the sizes given in Figure 3, and the various holes drilled. The parts are then fitted and the two holes marked E are countersunk. The ebonite piece, which forms the valve holder, is filed to the shape seen in Figure 4, and the holes bored in their exact position, including the two for the securing screws. The valve legs are fitted and the complete holder screwed to the panel. A substantial hinge is fitted to the end shown in sketch, screwing it first to the ebonite. This will not be difficult, providing small holes are first bored a little smaller than the size of screws used. Fixing a hook at the other end will complete the panel but for the connections, which are given in Figure 6.

The terminals should be boldly marked to eliminate the possibility of making wrong connections to the batteries, with the probability of

burning out the valve. To safeguard against the latter a pair of fuses could be put in circuit with the filament of the valve, fixing them in some convenient spot on the panel.

A. J. R.

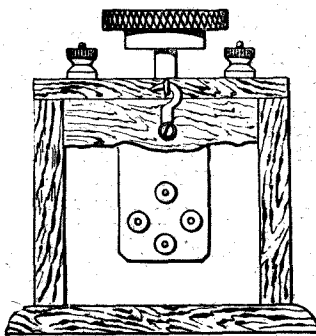

Fig. 2.—A sectional view.

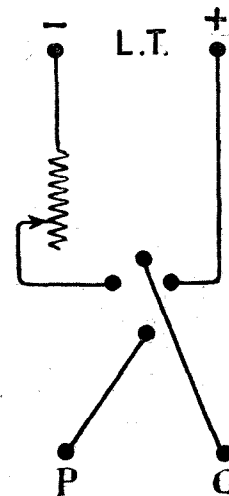
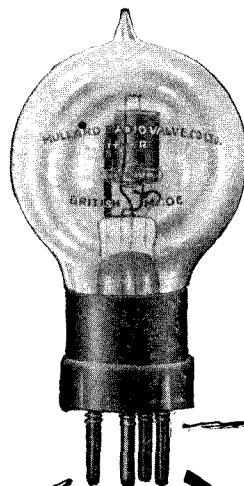
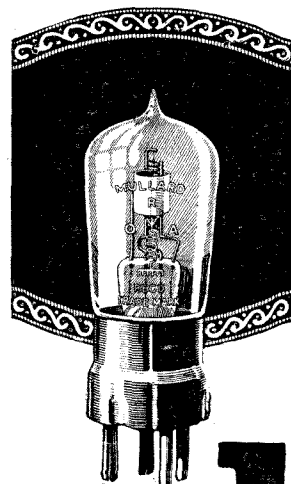

Fig. 5.—Wiring diagram.



MULLARD
 SUPERIOR
 WIRELESS
 VALVES
 REDUCED
 PRICE
15/-

PROBLEMS arise in every phase of life, and the power of concentration does not always solve them, but when the problem is one of valves you can see The Thinker straightening his heavy back and smiling because there is only one solution—



Mullard

Obtainable from the Leading Electricians, Wireless Dealers, etc.

Advt. of the Mullard Radio Valve Co., Ltd., Balham, S.W. 12.

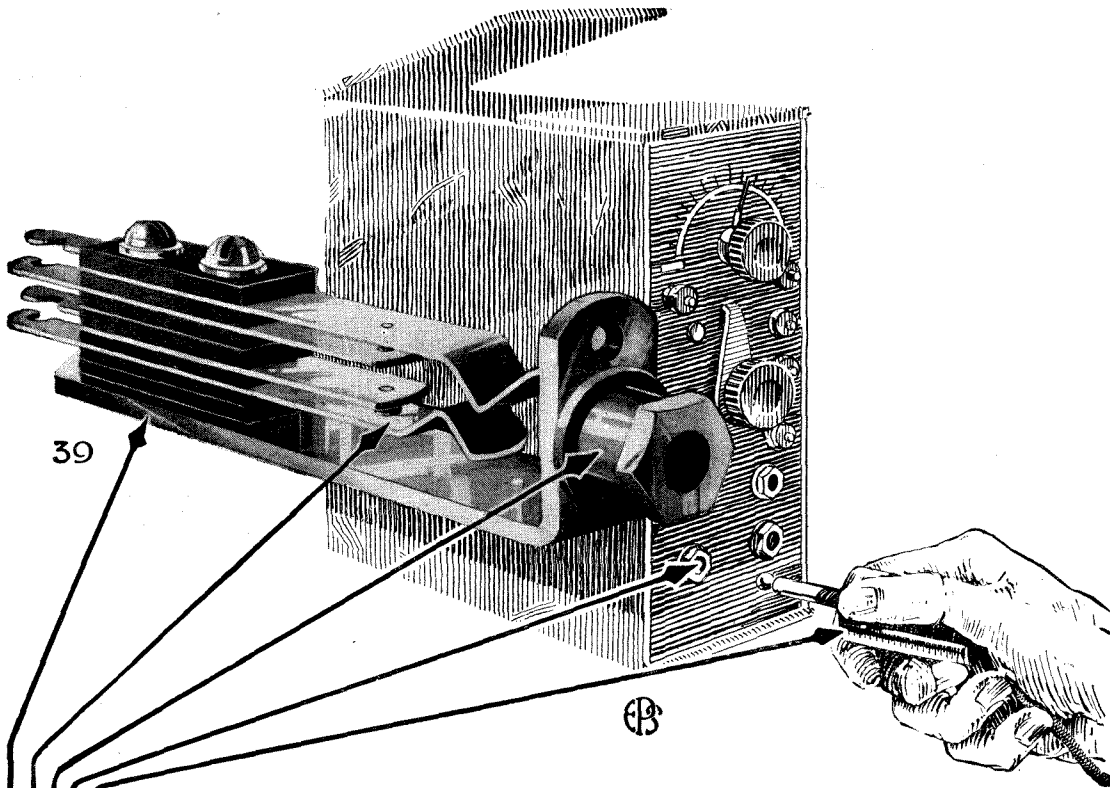

THE KEY TO YOUR SET.

The special ELWELL Plug attached to the flex of Telephones or Loud Speaker.

Inserting the Plug automatically lights the desired number of valves and connects up the Loud Speaker or Telephones.

Jacks are easily fitted—only one hole to drill. They take up very little room and look neat when in place.

Substantial contacts of pure silver will safely carry the filament current for seven valves.

Insulation between the blades tested up to 1,000 volts.

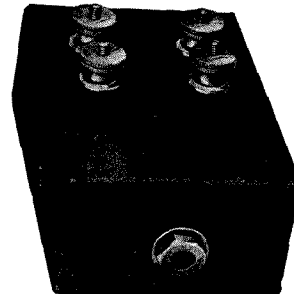

Jacks can also be supplied mounted in cases fitted with terminals as shown. Most convenient in use.

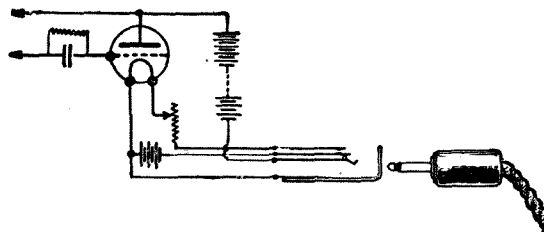

The Elwell Book of Diagrams (1s. 2d. post free) shows numerous circuits employing Plugs and Jacks. Elwell 56 pp. Illustrated Catalogue, 1/- post free.

Write for it to-day.

C.F. ELWELL, LTD.

Craven House, Kingsway, London W.C. 2.

Telephone: Regent 1607.
Telegrams: Elradioeng London

Cables: Elradioeng London
Western Union Code

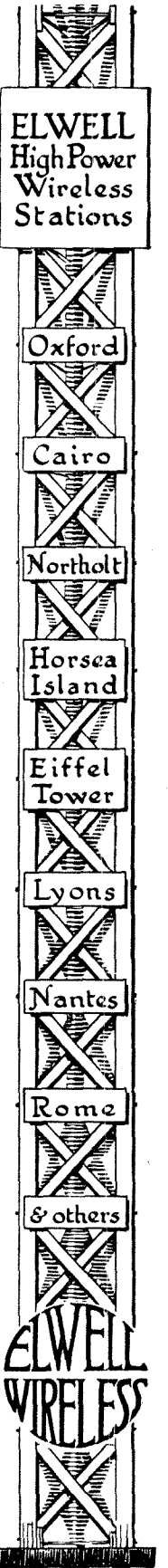

ADJUSTING FRAME AERIAL WINDINGS

By OSWALD J. RANKIN.

TO the enthusiast who takes a pride in the appearance of his instruments there is nothing more unsightly than a slack wire in a frame aerial. This is often very irritating, and the other wires, which are perhaps perfectly straight, seem to take a delight in exposing their unfortunate brother strand, or perhaps we should say "stranded brother." This slackness is not always due to carelessness on the part of the con-

A **B**



How to drill the peg holes and make the screw pegs.

structor. Frame aeri- als have a habit of toppling over even in the best of regulated workshops, and a slight knock will stretch a wire, or a number of wires, sufficiently to upset the appearance of the whole thing. When tightening a slack wire it is usually necessary to unwind the aerial to the point where the culprit lies, take up the slackness, and rewind again. With

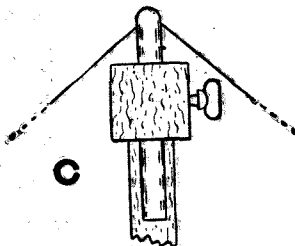

Method of fitting thumbscrews.

the arrangement to be described it is only necessary to make a simple adjustment should a wire or a number of wires become slack. A number of 3 in. lengths of $\frac{1}{4}$ in. round ebonite or fibre rod are carefully drilled through at one end to take the wire, and made to fit nicely into a series of holes drilled through the spreaders attached to the ends of the arms, as shown in the diagram. The spreaders

D

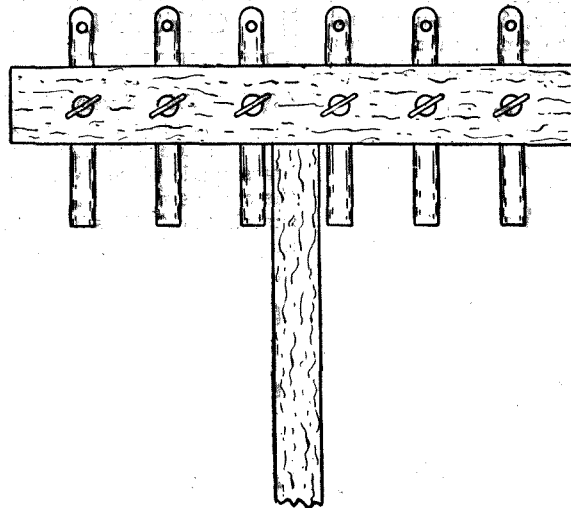

General arrangement of the device.

should preferably be made of well-seasoned oak, and long enough to accommodate from five to eight pegs, spaced about $\frac{1}{2}$ in. apart, according to the size of the frame and the number of turns it is proposed to wind on. Small holes are drilled in the sides of the spreaders to meet the peg holes, as shown in the sectional diagram A, and fairly stout steel wood screws are then screwed into

these holes and withdrawn again after making a sufficient impression inside the holes to act as threads for the screws, which are prepared as follows: The point is cut off each screw so that the flat portion thus obtained will grip the rod without damaging it, as would be the case if the point was left on, and small oval pieces of sheet metal are soldered into the slots to provide a means of manipulating

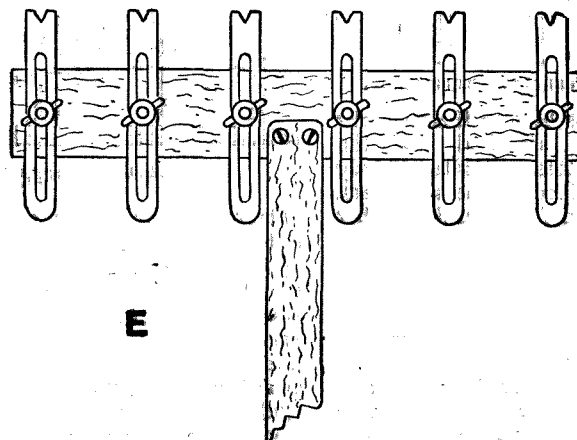

An alternative method of fixing the pegs.

the screws, in the same way as an ordinary thumb-screw. (See diagrams B and C.)

It will be seen how important it is to use hard wood, such as oak, for the spreaders. Matters may still be improved by using fibre, or better still, by employing threaded metal bushes and thumb screws made from machine screws, to fit the bushes. Small nuts could be soldered to small metal discs, or to a strip of metal screwed to the

F

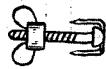

spreader. It is advisable, however, to avoid the use of too many metal parts.

The general arrangement of the device is shown in diagram D. If all four arms are so arranged, the winding is simplified considerably, since it may be wound on roughly and afterwards tightened up by means of the adjusting pegs.

Diagram E shows an alternative method of arranging the pegs, where flat strips of ebonite are slotted to take the shanks of the thumb screws, which, in this case, should be machine thread

G

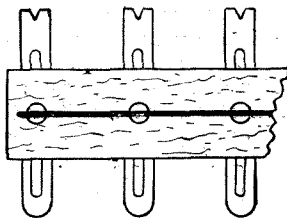

How to prevent the screws turning.

thumb screws having their shanks permanently attached to the spreaders. These are fitted tightly into holes drilled in the spreaders, and prevented from turning either by soldering a small staple to each screw head as shown at F, or by soldering a length of stiff wire along the screw heads as indicated in diagram G.

The writer suggests that inventors should get to work and devise some simple adjusting device on the lines set out above. Each wire, of course, must be controlled separately, and a series of small

ebonite cams may be a welcome suggestion to the reader with inventive faculties. The most important consideration is simplicity. Anything too complicated is not likely to prove a success.

INTERCHANGEABLE CRYSTAL CUPS

THESE are very simply made, it only being necessary to solder or otherwise secure a brass spade piece to the bottom of the cup, as shown in accompanying sketch "A." This little "fishtail" may be cut from thin brass of about

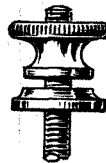

TERMINAL

A



ELEVATION

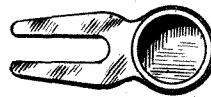

PLAN

How to make the cups.

24 or 26 w.g. It will be apparent that used in connection with a terminal, these cups can be very quickly changed, and adjusted to any position in the horizontal plane. They are best employed with the "Perikon" type of detector, a rough elevation of which is shown, "B," but they can be used with equal advantage on the usual type of ball and socket

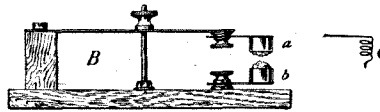

Method of fitting.

detector by inserting a terminal in the hole that is normally occupied by the screw which fastens the cup in such a detector, but when so used the "fishtail" or spade fastening will of course have to be bent to the shape shown in accompanying sketch, "C," as otherwise the cup would be mounted too high and come too near the "cat-whisker" holder. The writer employs some half-dozen of such cups

of various crystals, the name of each (or a letter standing for the name) being scratched on the

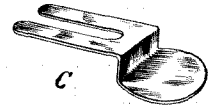

"fishtail," and he is thus enabled to change his crystals about with the utmost facility and certainty.

CATALOGUES, ETC., RECEIVED

WE have received from Messrs C. F. Elwell, Ltd., Craven House, Kingsway, an interesting and useful publication entitled "The Elwell Book of Diagrams." The book, which measured 8in. by 5in., contains on each page diagrams of both theoretical and practical interest to the experimenter.

This firm, as our readers know, specialises in a number of useful accessories for the amateur, particularly in plugs and jacks for rapidly connecting the telephones in different parts of the receiver. Diagrams are given for the wiring of all kinds of receivers, and a feature of considerable value is the publication, for each kind of set, of three diagrams, the first being a simple theoretical diagram, the second a practical wiring diagram and the third a fuller diagram showing how plugs and jacks can be connected up for valve and filament control. This book should be helpful to all amateurs, whether or not they are using the particular components referred to. The price is 1s.

From Messrs. Siemens Bros. & Co., Ltd., of Woolwich, we have received a leaflet giving particulars of their loud-speaking equipment. The Siemens Loud Speaker is made in three resistances: 120 ohms, 2,000 ohms, and 4,000 ohms. The low resistance type is made for use in conjunction with a telephone transformer.

Messrs. Siemens Bros. are also issuing descriptions of their dry batteries especially designed for use with low temperature or dull emitter valves. The leaflet gives particulars of large dry batteries which will supply the filament current for various types of dull emitter valves, and it is interesting to note that the table gives recommendations for the particular types of cell suited to the best known valves of this kind. The particular dry cells described are designed for use with one valve only.

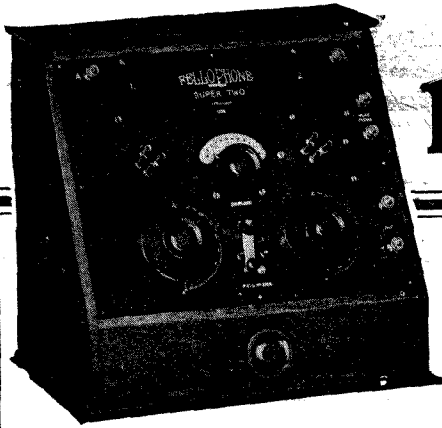

FELLOWS

AMUSEMENT ALWAYS

Wherever you are, under whatever conditions, the Fellows Super 2-Valve Set will bring the real pleasures of good entertainment produced in the best possible form to your door.

A 2-Valve Set of superior quality mounted in a highly-finished case, that will receive any British or Continental telephony even though the nearest Broadcasting Station is working.

PRICE: COMPLETE WITH H.T. BATTERY, ACCUMULATOR, 100 ft. 7/22 STRANDED COPPER WIRE, 2 INSULATORS, 1 pair 4,000 ohms HEADPHONES.

£15

plus B.B.C. tax, £1 15s.; Marconi tax, £1 5s.; and 2 valves.

A new 2-valve amplifier mounted in cabinet uniform with super 2 set, £6, plus B.B.C. tax £1, plus 2 valves.

FELLOWS MAGNETO CO., Ltd., LONDON, N.W.10.

Telephone :
Willesden 1560-1.

Telegrams :
"Quixmag," Phone, London.

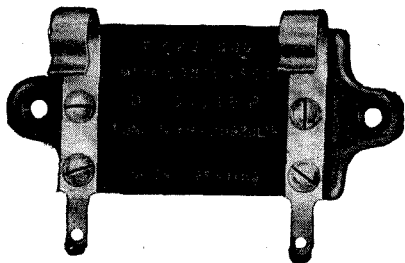
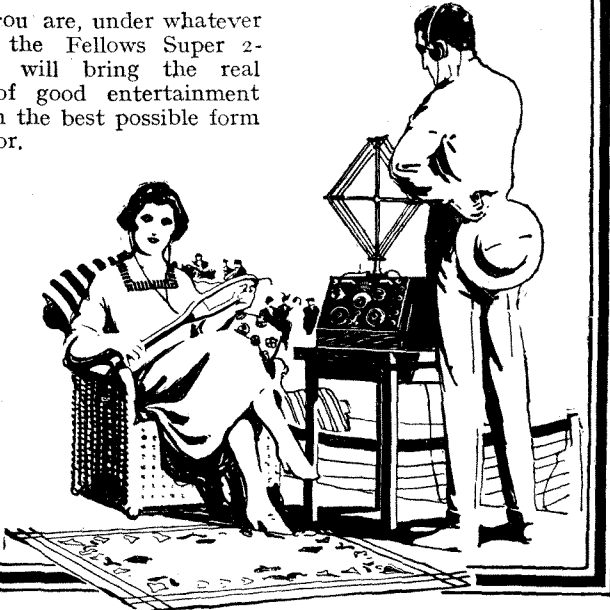

Type 600 with grid lead clips and soldering tags.

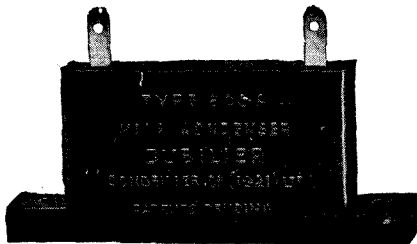

Type 600a.



Grid Lead

DUBILIER CONDENSERS

with the new

FLEWELLING 'SUPER' RECEIVING CIRCUIT

give wonderful results because our .006 mf. condensers are supplied in sets of 3 of exactly equal value. Experimenters should make up this powerful, inexpensive and easily worked circuit with this Dubilier set of 3 fixed condensers, as they ensure the very best possible results being obtained.

Price : 9/- per Set of Three.

THE DUBILIER CONDENSER CO. (1921) LTD., DEPT. D.
Ducon Works, Goldhawk Road, LONDON, W.12.

Telegrams : "Hivoltcon, Phone, London."
Telephone : Hammersmith 1084.

(E.P.S.15a).

It's the valve that counts!

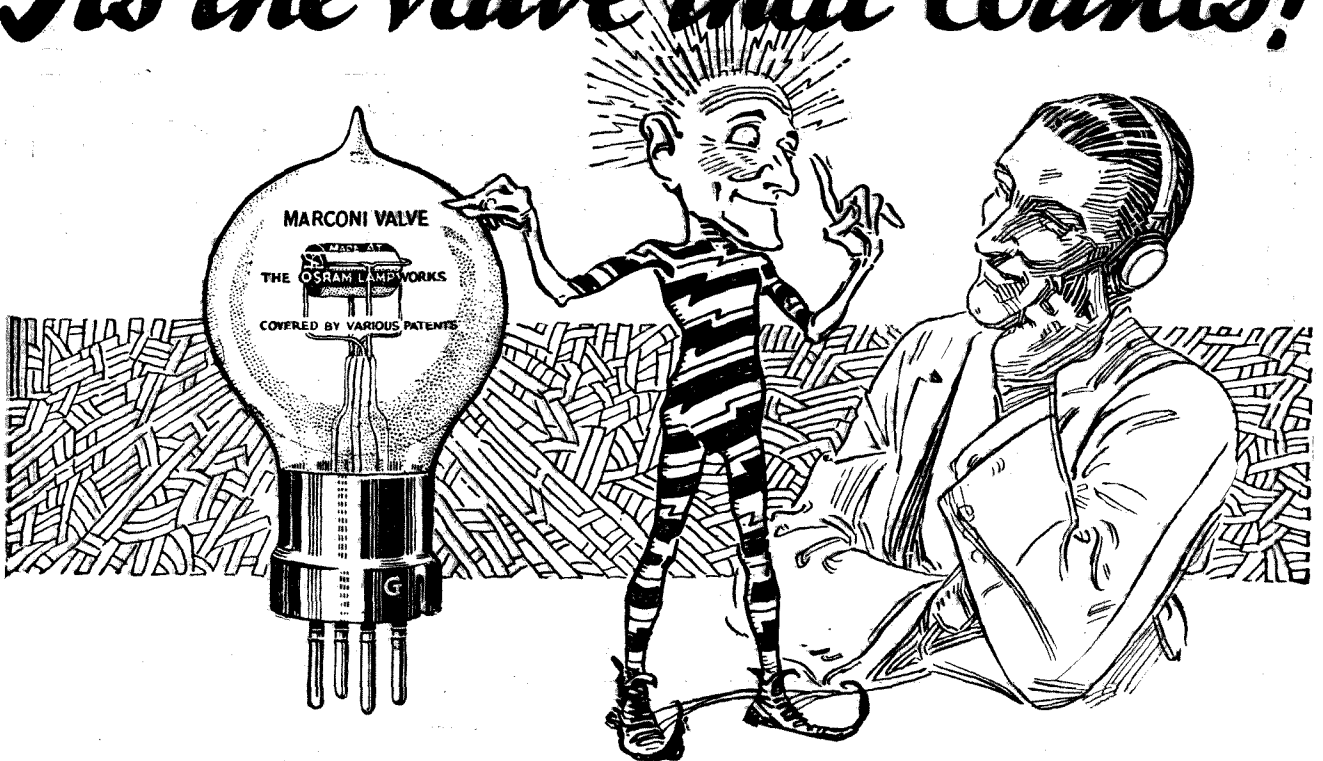

Users of valve receiving sets will do well to realise that the efficiency of their outfit is largely dependent upon their choice of valves. It's the valve that counts!

You will positively ensure the best reception of vocal and musical items by using

MARCONI VALVES

MADE AT THE OSRAM LAMP WORKS

Made with the same scrupulous care that has always characterised the manufacturing operations of the famous Osram factory.

MADE TO LAST

Sold by leading Electrical Contractors, Wireless Dealers and Stores.

(Wholesale only)

The General Electric Co., Ltd., Magnet House, Kingsway, London, W.C.2.

Branches throughout the United Kingdom and in all the principal markets of the World.

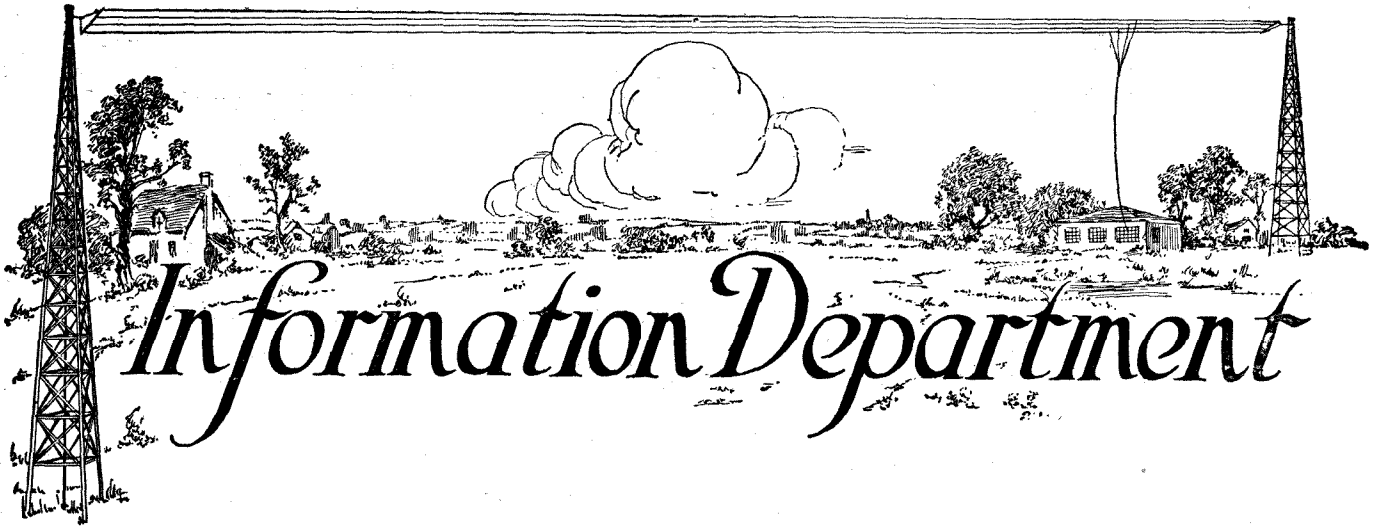

Information Department

Conducted by J. H. T. ROBERTS, D.Sc., F.Inst.P., assisted by A. L. M. DOUGLAS.

In this section will appear only selected replies to queries of general interest or arising from articles in "Wireless Weekly," "Modern Wireless" or from any Radio Press Handbook.

All queries will be replied to by post, as promptly as possible, providing the following conditions are complied with:—

1. A Postal Order to the value of 1s. for each question must be enclosed, together with the Coupon from the current issue, and a stamped addressed envelope.
2. Not more than three questions will be answered at once.
3. Queries should be forwarded in an envelope marked "Query" in the top left-hand corner and addressed to Information Dept., Radio Press, Limited, Devereux Court, Strand, London, W.C.2.

A. K. (Glasgow) submits a diagram showing a proposed counterpoise earth, and asks whether it would be satisfactory.

We are afraid your arrangement is not a good one. Under the circumstances you will obtain the best results from a direct earth, which should of course be as effective as possible. With reference to the rest of your enquiry, articles dealing with the subject you mention will be appearing in due course in "Modern Wireless" and "Wireless Weekly."

T. F. D. (Southport) wishes to know the most efficient type of high-frequency coupling to bring in the Hague and Paris telephony, and also asks questions about the connection of a plug-in high-frequency transformer.

The tuned anode arrangement is probably the most satisfactory high-frequency amplifier, and "Practical Wireless Valve Circuits," Radio Press, Limited, shows a number of useful applications of this principle. Referring to your question about the high-frequency transformer, unless we know how the pins are connected to the windings, we cannot indicate to what points in the circuit they should go.

L. P. submits two circuit diagrams, and asks whether reaction may be introduced into one or the other of them for the reception of British broadcasting.

Reaction cannot be used in No. 1, but on No. 2 may be introduced into the high-frequency amplifier. A simple method of doing this would be to use a two-coil holder so that you could plug in appropriate coils for the anode and reaction coils. These might be both of the same size.

T. C. A. (London) refers to a circuit diagram which has appeared in "Modern Wireless," and asks how the valves are coupled in this arrangement.

The two-valve set employs one high-frequency valve and a rectifier, and not a rectifier and a low-frequency valve.

G. W. (Dublin) sends us a sketch of his aerial, and asks whether it is satisfactory and if we could offer any suggestions.

Although your aerial will be rather badly screened, it is obviously as efficient as is possible under the circumstances. The tarred roof you mention will not affect the aerial in any way.

T. D. (Durham) refers to a piece of apparatus described in "Modern Wireless," and asks whether it is satisfactory.

This device represents the simplest possible way of obtaining the desired result with a minimum of trouble.

G. H. (Guildford) experiences trouble with a receiver which he has built, and asks whether we can help him.

If you will submit full particulars of the trouble you experience and the exact arrangement of your circuit, we will then be able to advise. We will take this opportunity of drawing our readers' attention to the fact that it is no use saying they have a set which does not work if they do not supply complete details describing the apparatus and the results they actually do obtain. The values of components should be clearly marked on the diagram.

J. A. D. H. (Hampstead) asks questions about the relative merits of different methods of connecting the grid leak.

The advantages of the different sketches you submit depend largely on the type of valve in use. It is sometimes found that by connecting one side of the grid leak to the positive filament leg, the tendency to self-oscillation of the set is checked. It is advantageous to have a switch so that the grid leak may be transferred to either the filament positive or negative leg for experimental purposes.

D. A. G. (Baker Street) sends us a diagram of his receiver, which he complains is very sensitive to capacity effects.

The reason for the presence of your body affecting the circuit is probably due to bad placing of the parts on the panel. We are afraid you will find it a difficult matter to control it in your case, but an extended spindle to the condenser across the tuned anode coil would probably greatly assist. There are distinct reaction effects produced in this circuit, but they are quite unintentional and do not cause radiation. This probably makes the tuning exceedingly critical.

G. P. H. (Kensington) made the coil winder described in "Modern Wireless" No. 1, but finds difficulty in keeping the wire on the former when winding.

You will find it quite a simple matter to wind coils correctly on this device if a strip of emery paper or cloth is first of all wound round the former, so that the rough face is outwards.

F. W. P. (Bermondsey) has built a 2-valve and crystal receiver described in "Modern Wireless," from which he obtains good results. He asks if he may expect to hear all the British Broadcasting Company's Stations with this receiver, and if not, could we suggest a suitable circuit.

We are afraid this receiver is not sufficiently sensitive to receive all the B.B.C. Stations except under the most favourable conditions. We suggest you use circuit ST.51 "Practical Wireless Valve Circuits," Radio Press, Limited. This circuit should be capable of operating a loud-speaker from all the B.B.C. Stations.

D. W. (Finchley) has a crystal receiver of which he submits particulars, and wishes to know whether he may expect to hear any shipping with this apparatus.

Your aerial is too small for the receiver to cover the necessary wavelength range as it stands. We suggest you use a plug-in honeycomb coil having about 50 turns in series with the aerial, when you should then be able to cover the desired range.

G. F. L. (N.W. 5) asks:—(1) What voltage of H.T. battery should be used in connection with the 2-valve Broadcast receiver described in "Wireless Weekly" No. 4. (2) For further details of the grid leak described in the above article. (3) What is the exact function of a fixed or variable condenser in a wireless receiving circuit.

(1) This depends to a great extent on the type of valve in use. In general it may be of a value not less than 60 volts. (2) A short piece of slate pencil should be used, and in order to adjust this to the correct value it may be necessary to draw one or two lines with a lead pencil along it until the best

results are obtained. (3) The principal functions of condensers in wireless receiving circuits are either to control the frequency of the circuits or to afford a by-path for high-frequency current.

C. M. T. (Wanstead) wishes to know of a good circuit employing high-frequency amplification, crystal rectification and one stage of note magnification.

Circuit ST.35 "Practical Wireless Valve Circuits," Radio Press, Limited, is as satisfactory a circuit for this purpose as can be desired. With careful adjustment you might obtain satisfactory results from Broadcast Stations up to 100 or 150 miles away.

R. N. H. (Glasgow) submits a circuit diagram and asks our opinion of it.

Your circuit arrangement is quite good, but we consider that the condenser across the aerial tuning inductance is somewhat too large. The range and usefulness of this receiver would be greatly extended if you fitted a series parallel switch for the aerial tuning condenser. Oscillation may be readily controlled by attaching a potentiometer to the grid circuit of the high-frequency valve. The effect you mention in connection with the low-frequency amplifier is quite in order, and can be disregarded.

T. H. P. H. (Glasgow) has a certain commercial pattern of receiver, and complains that certain notes of vocal and instrumental music are unpronounced and that orchestral music is unsatisfactory.

The reason for the undue prominence given to certain notes is that reaction is taking place in your receiver which greatly increases the selectivity of the apparatus to waves of a certain length. The modulation system employed at the transmitting end continually varies the wavelength above and below a certain point, and where reaction is taking place greater effects will be produced at certain wavelengths than at others. We suggest that as you are unable to interfere with the construction of this apparatus you should experiment with different values of H.T. battery, and shunt your H.T. battery and telephones with a fixed condenser which may be of large capacity.

H. R. (Edmonstone) asks the wavelength of a coil having 100 turns of No. 28 gauge wire wound on a 4-inch former with a variable condenser of 0.0005 μ F capacity connected permanently in series with it.

The exact wavelength will depend upon the characteristics of your aerial circuit, and to a certain extent upon the set itself. An average value for such a coil would be from 80 to 450 metres.

A. L. R. (Highgate) asks whether he would obtain better results with a crystal set when using a 4-, 5- or 6-wire cage aerial than a single wire.

We do not think you would obtain a great increase in signal strength, although a 6-wire cage would ensure the maximum current being delivered to the receiver. The minimum diameter for the hoops used to space the wires should be 2 feet, and these should be in metallic contact with the wires at all points. It is therefore only necessary to insulate the ends of the aerial from the mast as in the ordinary way. The lead-in should have the same number of wires as the cage itself, which should be joined together just before entrance to the building. Your sketch appears suitable.

Components of Quality

| | | |
|--|---|---|
| AERIAL WIRE —Bare, 100' .. 3/3 150' .. 4/9 | CONDENSERS , Polar, .001 .. 14/3 | INTERVALVE TRANSFORMERS 14/- |
| BRASS LAMINATED SWITCH ARMS (laminations similar to W.D. Type) .. 2/9 | CONDENSER VANES , special slip-in type .. pair .. 2d. | SYSTOFLEX TUBING per yd. .. 5d. |
| COILS (Tingey Patent): | CONTACT STUDS with nuts and washers .. per doz. .. 11d. | TERMINALS , with 2 nuts, per doz. .. 2/6 |
| A*, 150-450m. £1 | DEWAR SWITCHES , new, not ex-Government, 3-way .. 8/- | TELEPHONE TRANSFORMERS for 120 ohm 'phones, own make 12/- |
| A, 300-2,000m. £1 5/- | DEWAR SWITCHES (ex-Government), 3-way 4/- | VALVE LEGS , with nuts and washers .. per doz. .. 1/3 |
| B, 1,000-8,500m. £1 17/6 | EBONITE , 1/4", cut to size lb. .. 4/- | VALVE HOLDERS , with flange, with washers and nuts .. 10d. |
| C, 5,000-24,000m. £3 2/6 | FILAMENT RESISTANCES on Erinoid Former 3/- | VALVE HOLDERS , fitted with 4 terminals, G.P.F. plus and minus 2/6 |
| CONDENSERS , for panel mounting:— | GRID LEAKS and Anode Resistances, any value, own make .. 2/- | WIRE , cotton and silk. All grades. |
| .001 10/6 | HEADPHONES —Brown's and Sterling's. | |
| .0005 6/9 | INSULATORS , Reel 2d. | |
| .0002 4/6 | Egg 3d. | |
| .00005 3/3 | Shell 9d. | |
| CONDENSERS , sets of parts:— | Keystone 6d. | |
| .001 9/- | | |
| .0005 5/6 | | |
| .0002 3/6 | | |
| .00005 2/3 | | |

We manufacture Valve Sets—1, 2, 3, 4 and 5 Valves, also an excellent Crystal Set.

Send for our new Components LIST—free on request.

Offices and Showrooms: 92, QUEEN ST., HAMMERSMITH, LONDON, W.6.

'Grams: "Tingoidar, London."

'Phone: Hammersmith 1916.

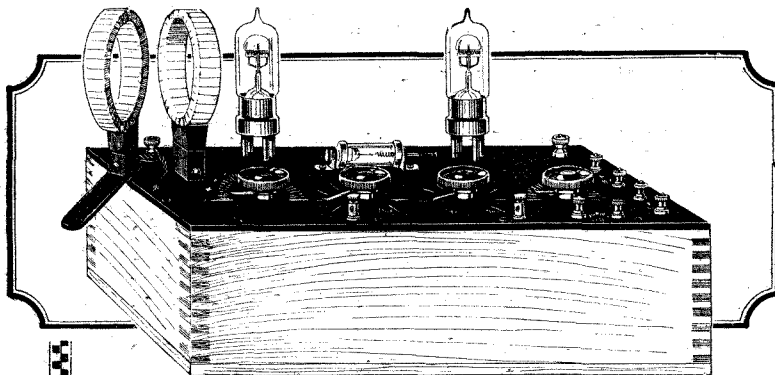

Complete Instrument ready for home assembly

includes the following:

- Teak Cabinet 15 in. by 7 in.
- Ebonite panel, drilled and engraved.
- 100,000 ohms (Peto-Scott) Resistance with clips.
- Two fixed Condensers .002 and .0003 (in ebonite).
- 2 Max.-Amp. Transformers.
- Glass covered Crystal Detector.
- 2 Filament Resistances.
- 2 Variable Condensers .0005 (in sets of parts).
- Coil Holders.
- Insulated Wire and Blue print.

£4-10-0
Post Free.

Peto-Scott Co., Ltd.,

Head Office: 14, HIGH HOLBORN, W.C.1
 Demonstration Lounge: 99, HIGH HOLBORN, W.C.1
 Branch: 3, WELLINGTON ST., STRAND, W.C.2

Here's the new S.T. 100 as erected by us

NOT a collection of components but a real working model of the famous S.T. 100 which has been erected and thoroughly tested by our technical staff.

The Ebonite panel has been laid out for correct spacing of components, all holes drilled and tapped and scales, etc., engraved on the actual ebonite itself.

A Blue print is supplied free, and if instructions are followed the Set will work perfectly. A fine quality polished teak cabinet as above is also supplied without any extra charge.

Note that this is the latest improved S.T. 100 with terminals arranged for Grid cells.



—a necessity for every Experimenter

Contents

1. Fleming Valves.
2. The 3-Electrode Vacuum Tube.
3. Cascade Vacuum Tube Amplifiers.
4. Regenerative Amplification and Self-oscillation.
5. Regenerative Reception of Signals.
6. C.W. Receiving Circuits.
7. Vacuum Tube Transmitters.
8. Radio-Telephony employing Vacuum Tubes.
9. Further Vacuum Tube Amplifications.

10/-

post free

THIS Book should be in the hand of every Experimenter who wants to obtain a thorough understanding of Wireless.

It is recognised as the only standard Text Book sold at a price within the reach of anyone. Beautifully bound in solid cloth and plentifully illustrated with circuit diagrams and charts it is a vital necessity to the student, the research worker and the designer. If you are building a Set for pleasure or for profit, get a copy of this Book and understand the fundamental principles of Radio.

Obtainable from all Booksellers or direct from Publishers:—

RADIO PRESS, LTD.,
Devereux Court, Strand, W.C.2

SOME NOTES ON THE DESIGN OF AERIALS FOR SHORT WAVE TRANSMISSION.

To obtain good results upon the short wave band it is essential that great care should be exercised in the design of the aerial and earth system.

THE antenna system of a wireless transmitter is the medium by which the radio frequency currents transmitted are converted into ether waves; in this light we must regard it, and the means of securing the most effective radiation of these ether waves from it with the minimum loss.

Whilst it is true that an aerial used for transmission (so far as the experimenter is concerned) will usually be of high efficiency for the reception of wireless signals, it does not necessarily follow that a good receiving aerial will be a suitable medium for the transmission of wireless waves. This especially refers to waves of 200 metres and under, the purpose of this article being chiefly to deal with such short waves and the most efficient methods of propagating them through the ether.

Let us, therefore, examine the several types of aerial which have proved to be the most suitable for these short wave-lengths. The best radiator is a thoroughly impracticable design, consisting of a highly conductive sphere of metal after the pattern used upon "toy" wireless apparatus; but as this would require to be of very considerable size, at least 80 feet in diameter, to be of practical use, we may leave it out of the question. The next most useful form will be in the nature of a vertical rod or pole of metal, highly insulated at the base and of generous cross-section, preferably tubular. Whilst this forms a most useful radiator for waves of 100 to 150 metres, it must not be regarded as ideal, as an aerial should function to the best advantage at approxi-

mately its fundamental wave-length (in this instance four times its height), which would mean a mast 164 feet high to secure the best results at 200 metres.

For practical reasons we therefore seek to modify this so that a lower mast or masts may be used. Several ways of doing this present themselves, but one of the most useful arrangements is shown in Fig. 1, where we have a pole of approximately a quarter of the height having four divergent radiator wires of large cross-

section, and each of the length of the pole, so disposed as to form an "umbrella" shape. These wires are heavily insulated top and bottom, and are connected together at the top in the manner indicated; a suitable form of down-lead from this type of aerial is also shown.

This may be considered the most efficient practical radiator for wave-lengths of from 150 to 200 metres, and should be more extensively used than it is. The insulation resistance to earth must be very high, and for this reason, although it does not

actually form part of the radiating system, the centre supporting mast must be insulated top and bottom. A suitable way of doing this is shown in Fig. 2. Four wires 40 feet long connected in this manner form an excellent aerial for short-wave transmission.

This type of aerial also presents unrivalled facilities for the use of a counterpoise earth, which will be subsequently described. The radiation resistance is low and there are, therefore, few losses of any kind from this source.

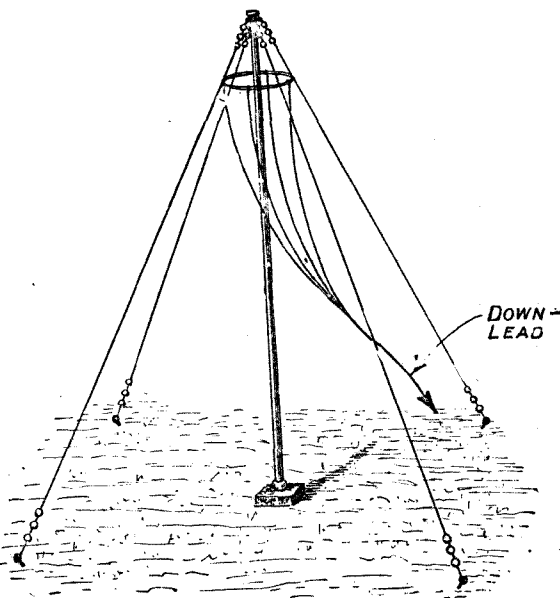

Fig. 1.—An umbrella type aerial.

The chief losses in any radiating antenna system are due to—

- (1) Loss in the actual conductors due to their resistance ;
- (2) Loss in the tuning apparatus (*i.e.*, coil and condenser in series with the aerial) for the same reason ;
- (3) Loss due to heat generated in the earth lead from its resistance ;
- (4) Loss due to leakage through insulators ;
- (5) Loss due to the induction of currents in neighbouring metallic structures, such as poles, wires, towers, buildings, etc.

All these things must be taken into consideration for experimental transmissions, the more so as the frequency of the current renders it all the more prone to leak ; the frequency of a 150-metre wave is 2,000,000 per second, and that of a 200-metre wave 1,500,000 per second.

It is, therefore, most important that we should conserve as much of this energy in the

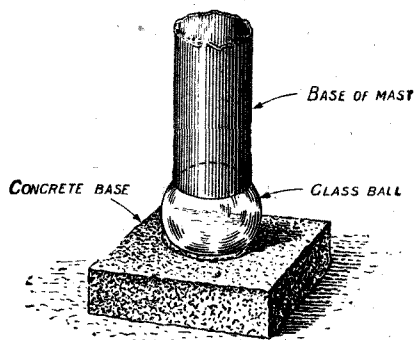

Fig. 2.—Showing a method of insulating a steel mast from earth.

aerial as possible, and it is to the various means of doing so that we wish to draw the reader's attention. The resistance loss in an aerial varies inversely as the square of the wave-length ; it is therefore obvious that to secure the most efficient radiation with the *least possible loss* the transmitter should be operated at a wave-length corresponding with the fundamental wave-length of the aerial. It is generally necessary to insert a small coil in the aerial circuit in order to couple the power circuit to it, or to transfer the radio frequency energy to it, but a series condenser will again shorten the wave-length to the required value. For this reason the series condenser should have low losses, mica dielectric being generally preferable, although an air or oil dielectric condenser may be used.

The fundamental wave-length is not that at which the maximum current is secured, but

that at which the maximum of the expression C^2R_a is obtained, C being the current and R_a being the radiation resistance of the aerial system. The aerial ammeter, therefore, does not give a true indication of the actual radiation from the transmitter, and this should be borne in mind.

At this point it will be useful to indicate another form of antenna construction which is an excellent radiator, so that the man who is anxious to "get on with the job" can do so. This type is indicated in Fig. 3 and is known as the cage or "sausage" aerial. High frequency currents flowing in such a system tend to crowd towards the outside of the wires, and in this arrangement we prevent excessive concentration upon any one spot and so avoid heat and losses, and at the same time secure even radiation.

A suitable arrangement for such a cage aerial would be six wires spaced evenly round $2\frac{1}{2}$ foot steel hoops, with which they should be in actual metallic contact. These wires might be 70 feet long, and they should be gathered together at each end into a point as indicated, and well insulated from the guy wires ; a number of insulators in series are better than any one of a particular pattern. The lead-in from this aerial should be tapered as shown, and will have a low resistance on this account ; the same number of wires may be used for it as for the aerial cage itself.

Such an aerial need not be a great height from the ground to be efficient, but 40 feet is

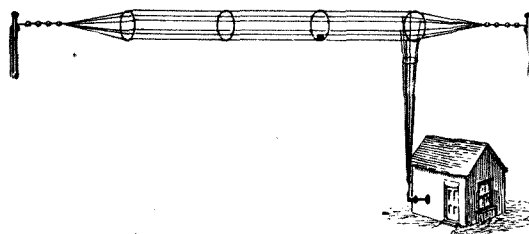

Fig. 3.—The cage type of aerial.]

suggested as a useful figure and can be exceeded where circumstances permit. It is hardly necessary to point out at this stage that high frequency currents travel *on* a wire and not in it ; for this reason the conductors used should be of as generous a cross-section as convenient, and the most useful method of attaining efficiency in this direction is to use stranded copper wire for the aerial system.

A. L. M. D.

DIRECTORY OF SUPPLIERS

"TO WIRELESS SUPPLIERS."—Half inch in column spaces for names and addresses and particulars of apparatus supplied in the districts of this Directory are offered at the rate of 10s. per insertion, or 12 insertions £5 5s. 0d. prepaid. Communications with remittance should be sent to Scheff Publicity Organisation, Ltd., 125, Pall Mall, London, S.W.1. Advertisers are included under one district without charge.

LONDON.

RADIO SOCIETY OF GREAT BRITAIN.

Hon. Sec.: 32, Quex Road, West Hampstead, N.W.6.

BATTERSEA AND DISTRICT RADIO SOCIETY.

Hon. Sec.: 31, Holden St., Lavender Hill, S.W.11.

SUPPLIERS:

American Hard Rubber Co. (Britain), Ltd., 13A, Fore Street, E.C. 2.

British L.-M. Ericsson Manufacturing Co., Ltd., 63, International Buildings, Kingsway, W.C. 2.

S. G. Brown, Victoria Road, North Acton, W. 3.

Burne-Jones & Co., Ltd., Montford Place, Kennington Road, S.E. 11.

Canadian Brandes, Ltd., Walmer House, 296, Regent Street, W. 1.

City Accumulator Co., 79, Mark Lane, E.C. 3.

Cossor Valve Co., Ltd., Highbury Grove, N. 5.

The Dubilier Condenser Co. (1921), Ltd., Ducon Works, Goldhawk Rd., Hammer-smith, W. 12.

Economic Electric Ltd., 10, Fitzroy Square, W. 1.

Edison Swan Electric Co., Ltd., 123, Queen Victoria Street, E.C. 4.

C. F. Elwell, Ltd., Craven House, Kingsway, W.C. 2.

Fallon Condenser Co., 230A, Hermitage Road, N. 4.

Fellows Magneto Co., Ltd., Cumberland Avenue, N.W. 10.

Gambrell Brothers, Ltd., Merton Road, Southfields, S.W. 18.

LONDON (continued).

General Electric Co., Ltd., Magnet House, Kingsway, W.C. 2.

General Radio Co., 105, Gt. Portland Street, W. 1.

Alfred Graham & Co., St. Andrew's Works, Crofton Park, S.E. 4.

Holborn Radio Co., Ltd., 267, High Holborn, W.C. 1.

Igranic Electric Co., Ltd., 147, Queen Victoria Street, E.C. 4.

Jackson Bros., 8, Poland Street, Oxford Street, W. 1.

WIRELESS INVENTORS.
Advice Handbook on Patents and Trade Marks. Consultations free.—B. T. King, Regd. Patent Agent, 146a, Queen Victoria St., E.C. 4. Phone: Central 682. 36 yrs. refs.

Leslie McMichael, Radio Corner, Strand, W.C. 2.

Lissen Company, 16-20, Woodger Road, Goldhawk Road, Shepherd's Bush, W. 12.

Marconi Wireless Telephone Co., Ltd., Marconi House, Strand, W.C. 2.

Mullard Radio Valve Co., Ltd., 45, Nightingale Lane, Balham, S.W. 12.

Negretti & Zambra, 38, Holborn Viaduct, E.C. 1.

Peto-Scott Co., Featherstone House, 6, High Holborn, W.C. 1.

Radio Communication Co., Ltd., 34-35, Norfolk Street, Strand, W.C. 2.

Radio Components, Ltd., 19, Rathbone Place, W. 1.

LONDON (continued).

Radio Equipment Co., 329, High Holborn, W.C.

Radio Instruments, Ltd., 12, Hyde Street, W.C. 1.

M. Raymond, 27, Lisle Street, W.C. 2.

Richford & Co., 153, Fleet Street, E.C. 4.

Robinson, Lionel & Co., 3A, Staple Inn, W.C. 1.

Simpson & Blyth, 8, Sherwood Street, W. 1.

Sterling Telephone & Electric Co., 210, Tottenham Court Road, W. 1.

Thames Electric Wireless Co., 40, Old Town, Clapham, S.W.

Tingey Wireless Ltd., 92, Queen Street, W. 6.

Western Electric Co., Ltd., Connaught House, Aldwych, W.C.

The Wilkinson Motor and Engineering Co., 10-14 and 29-33, Lonsdale Road, Kilburn, London, N.W. 6

BELFAST.

SUPPLIERS:

The Electrical Installation & Repairing Co., 40, Berry St., Belfast. Phone: Belfast 3659.

BIRMINGHAM.

BIRMINGHAM EXPERIMENTAL WIRELESS CLUB.

Hon. Sec.: 110, Ivor Road, Sparkhill.

BRADFORD.

SUPPLIERS:

J. DYSON,
5 & 7, Godwin Street, Bradford. Complete
Sets. All Accessories. Tele. 6037 & 6033
Telegrams: "Equipment."

BRIGHTON.

BRIGHTON AND HOVE RADIO
SOCIETY.
Hon. Sec.: 68, Southdown Avenue,
Brighton, Sussex.

SUPPLIERS:

H. J. Galliers, 32, St. James's Street,
Brighton. Agent for Burndept, Ltd.

DORSET.

EAST DORSETSHIRE WIRELESS
SOCIETY.
Hon. Sec.: "Hillmorton," Ringwood
Road, Newtown, Parkstone.

EDINBURGH.

EDINBURGH AND DISTRICT RADIO
SOCIETY.
Hon. Sec.: 9, Ettrick Road, Edinburgh.

SUPPLIERS:

EDINBURGH.
Spensers (Scotland), Ltd., 119, George St.,
Edinburgh. Agents for Burndept, Ltd.

William Sinclair, 60-64, Thistle Street. All
component parts in stock at lowest prices.

GLASGOW.

SUPPLIERS:

ROBERT BALLANTINE
St. Vincent St., Benfield St. Corner, Glasgow.
Sole Agent
Glasgow & District for L. McMichael, Ltd.,
London.

GUILDFORD.

SUPPLIERS:

Drummond Brothers, Guildford.

HALIFAX.

HALIFAX WIRELESS CLUB AND
RADIO SCIENTIFIC SOCIETY.
Hon. Sec.: Clare Hall, Halifax.

SUPPLIERS:

Electrical Supply Stores, 11, Fountain
Street, Halifax.

ILFORD.

ILFORD AND DISTRICT RADIO
SOCIETY.
Hon. Sec.: 77, Khedive Road, Forest
Gate.

LEEDS.

LEEDS AND DISTRICT AMATEUR
WIRELESS SOCIETY.
Hon. Sec.: 37, Mexborough Avenue,
Chapelton Road, Leeds.

SUPPLIERS:

British Wireless Supply Co., Ltd., 6,
Blenheim Terrace.

LEICESTER.

LEICESTERSHIRE RADIO AND
SCIENTIFIC SOCIETY.
Hon. Sec.: 269, Mere Road, Leicester.

LIVERPOOL.

LIVERPOOL WIRELESS SOCIETY.
Hon. Sec.: 138, Belmont Road, Liverpool.

MANCHESTER.

MANCHESTER RADIO SCIENTIFIC
SOCIETY.
Hon. Sec.: 16, Todd Street, Manchester.

MANCHESTER (continued).

SUPPLIERS:

A. Franks, Ltd., 95-97, Deansgate, 44,
Market Street, 73, Oxford Street,
12, Victoria Street, Manchester, and
90, Bradshawgate, Bolton.

Universal Electric Supply Co., 4, Brown
St., Manchester.

Ward & Goldstone, Ltd., Frederick Road,
Pendleton.

NEWCASTLE-ON-TYNE.

NEWCASTLE AND DISTRICT AMA-
TEUR WIRELESS ASSOCIATION.
Hon. Sec.: 51, Grainger St., Newcastle-
on-Tyne.

SUPPLIERS:

WALKERS' WIRELESS
Hold the largest variety of wireless apparatus
in the North. Send for particulars.
31, Westgate Road, Newcastle-on-Tyne.

NOTTINGHAM.

NOTTINGHAM AND DISTRICT
RADIO EX. ASSOCIATION.
Hon. Sec.: 99, Musters Road, W. Bridg-
ford, Nottingham.

POOLE.

EAST DORSETSHIRE WIRELESS
SOCIETY.
Hon. Sec.: Abbotsford, Serpentine Road,
Poole.

PRESTON.

SUPPLIERS:

Geo. Wilkinson, Wireless Specialist, 152,
Church Street, Preston (opposite Miller
Arcade). General Supplies.

TUNBRIDGE WELLS.

SUPPLIERS:

H. Featherstone, A.M.I.E.E., Wireless and
Electrical Engineer, 22, London Road,
Tunbridge Wells. Agent for Burndept
Wireless Apparatus. Tel. 610.

SPECIAL CIRCUITS

For best results buy the best components.

Obtainable from

Burne-Jones & Co., Ltd.
Manufacturing Radio Engineers,
Montford Place, Kennington Rd.,
London :: :: S.E. 11.

'Phone: Hop 6257.

1,000 ohm resistances with clips. 2/6 post free.

All Previous Lists Cancelled.

'Phone: Willesden 1336

THE WILKINSON MOTOR & ENGINEERING CO.,
10, 12, 14, 29, 31, 33, Lonsdale Rd., Kilburn, N.W.6.
H. E. WILKINSON, M.J.I.E., Proprietor. Same Address since 1900.

" EIFFEL TOWER " MASTS

The Masts are built of selected wood soaked in creosote, all main parts are
screwed together (not merely nailed) and banded with galvanised iron.
The Mast is sent out in 10-ft. sections, complete with screws for assembling.
These Masts are triangular in shape and made of triangular material, giving
great strength combined with lightness.

PRICES:—CASH WITH ORDER. CARR. FORWARD.

| | | |
|---------------|-------------------|----------------------|
| 20 ft.—22 0 0 | ... Weight 30 lb. | ... Base Size 16 in. |
| 30 ft.—3 0 0 | ... " 50 " | ... " 22 " |
| 40 ft.—3 17 6 | ... " 70 " | ... " 28 " |
| 50 ft.—4 15 0 | ... " 90 " | ... " 29 " |

MAST SUNDRIES—

Seven Strand Rigging Wire in 50
and 100 ft. coils, 1/9 and 3/6 each.
Rigging Strainer Screws (Gal.) 1/- each
Wall Hooks 1/6 doz.
Galvanised Pulleys ... 1/6 each.
Special Tarred Hemp Halyards,
50 ft. 2/6; 100 ft. 5/- and pro rata.
Green Shell Insulators... 6/- doz.

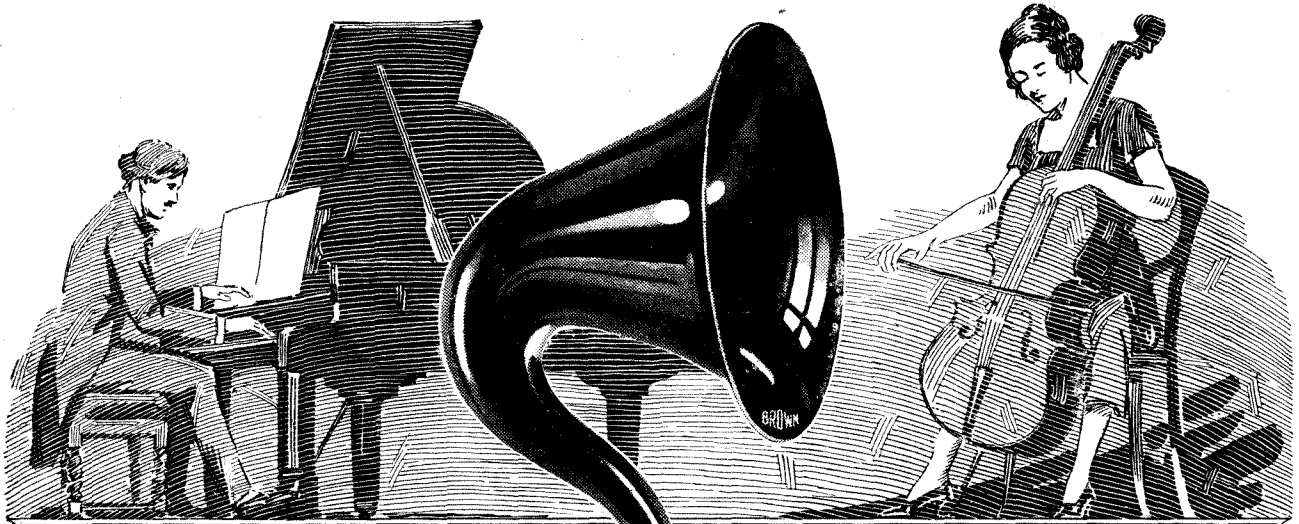

PURITY of TONE

THE Brown Loud Speaker—because it incorporates the same principle as the well-known A type headphone—is deservedly famed for the purity of its tone.

To hear music reproduced on the Brown is to hear music at its best. The human voice, the 'cello, the flute, the piano, the saxophone—all are reproduced with startling reality.

Just as there is only one Brown Headphone—with its aluminium diaphragm

and moving reed—so there is only one Brown Loud Speaker. No other can be so good.

Before you buy your Loud Speaker, hear a **Brown**—you'll appreciate its superb powers of reproduction, and realise that in design and manufacture it conforms to the well-known Brown standard of quality.

| Model H1, 21 in. high. | | | Model H2, 12 in. high. | | |
|------------------------|---------|--|------------------------|---------|--|
| 120 ohms ... | £5 5 0 | | 120 ohms ... | £2 5 0 | |
| 2000 ohms ... | £5 8 0 | | 2000 ohms ... | £2 8 0 | |
| 4000 ohms ... | £5 10 0 | | 4000 ohms ... | £2 10 0 | |

From all Dealers.

Brown

S.G. BROWN LTD. WORKS—VICTORIA ROAD, N. ACTON, W.3.
LONDON SHOWROOMS—19 MORTIMER ST. W.1.

A triumph of inventive genius

The only receiver that will reproduce music and speech EXACTLY



ENTIRELY BRITISH MADE.

All the faults of the ordinary magnetic type receivers have been eliminated in the "Polar" Dynaphone. It is constructed on the electro-dynamic-coupled magnetic principle and is the only receiver made which can *exactly* reproduce music and speech. The "Polar" Dynaphone is efficient, small, light, impervious to variations in temperature and comfortable to wear.

The wire used in the coils is much larger in diameter and more robust than in the ordinary phones and the insulation is much better owing to sufficient space being allowed to impregnate the whole coil thoroughly.

Eddy Currents are made use of because the whole phone functions as a transformer, the windings being the primary and the diaphragm itself the secondary. Further, the induced currents in the diaphragm follow exactly the variations of current in the winding, not being affected by any direct current component or by the iron of the magnetic circuit, as this is not a closed core. The diaphragm current, reacting with the permanent magnetic flux, produces a vibration of the diaphragm, which is perfect. The eddy current losses in the "Polar" Dynaphone are practically eliminated by radial slots which prevent their flow.

The magnetic circuit, having a short, mean path and a large cross-sectional area, is about four times the efficiency of the ordinary phone. There is a magnetic effect as in the ordinary phone coupled with the electro-dynamic effect, the result is a much more perfect reproduction than can be secured with magnetic action alone, the pull on the diaphragm is over a circle about one third of the diameter of the diaphragm,

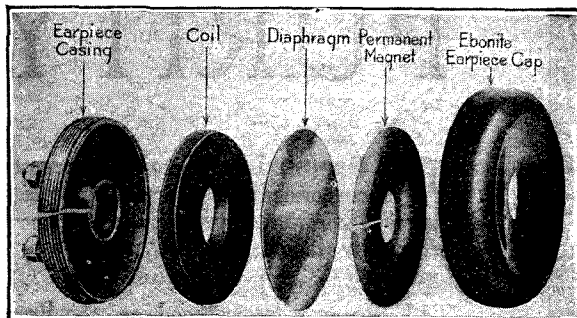

thus obviating distortion created by distorted pull on the diaphragm.

Both sides of the diaphragm are equally damped, an area at the centre of the back of the diaphragm equal to the area of the opening in the ear cap is free to the air. This acoustical arrangement results in the fulness of tone as compared with the shallow tone produced by the ordinary phone. Music of any kind reproduced by the "Polar" Dynaphone is *faithfully* reproduced, the quality of the notes and timbre being clearly discernible. Those who have used the ordinary wireless head sets will know that a man's voice is usually reproduced as a deep bass, this is not so with the "Polar Dynaphone."

POLAR
DYNAPHONE
is obtainable from all "Polar" Stockists or direct
RADIO COMMUNICATION CO., LTD.,
34/35, NORFOLK STREET, LONDON, W.C.2.

Telephone: Central 8480 (3 lines).

Telegrams: Radiocomco-Estrand, London.

Where you see the "Polar" sign—you can buy "Polar" accessories.

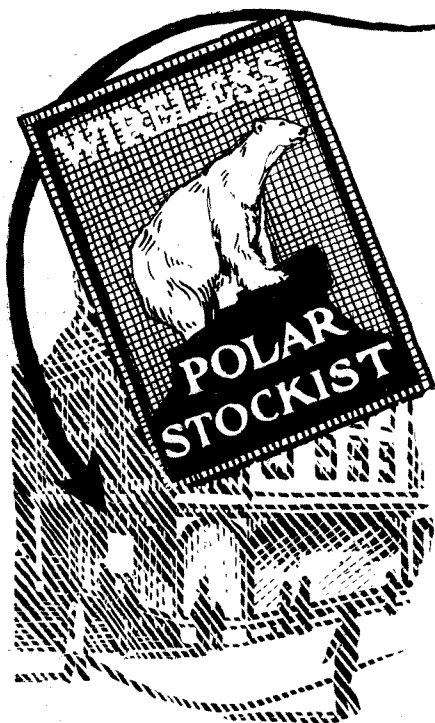

Where you see the
'POLAR'
 SIGN
 you can buy
POLAR
 ACCESSORIES

The "Polar" sign illustrated here is now displayed in the windows of "Polar" Stockists throughout the Kingdom—the most effective answer we can possibly think of to the hundreds of wise wireless enthusiasts whose urgent enquiry is "Where can I buy 'Polar' Accessories?"

The following is a brief advanced list of "Polar" Stockists—watch it grow:

- ARBROATH.—Ponsford & McHardy, 165, High St.
 BARRY DOCK.—Lewis & Mayer, Eebway Rd.
 BECCLES.—G.F.M. Engineering Co., 5, Smallgate.
 BELFAST.—Phoenix Radio Co., 5, Donegal Sq. East.
 BERWICK-ON-TWEED.—King Bros., 25, Bridge St.
 BIRKENHEAD.—Hughes and Watts, Ltd.
 BIRMINGHAM.—Midland Counties Electric Engineering Co., Ltd., 136, Sandon Rd. A. E. Parsons, 142, Park Road, Aston.
 BOLTON.—A Franks, Ltd., 90, Bradshawgate.
 BRADFORD.—The Gramophone Stores, 150, Bowling Old Lane. Chris. Pratt & Sons, Ltd., North Parade.
 BROUGHTY FERRY.—Ponsford & McHardy, 58, Grey St.
 CAMBRIDGE.—Negus Electrical Co., 22, Regent St.
 CARDIFF.—R. W. Brasington, 33, Morgan Parade. Cardiff Electric Wireless Supply Co., Ltd., 43, Bute St. J. Howell & Co., Ltd., South Wales Wireless Installation, Ltd., 18, West Bute Street.
 CHESTERFIELD.—Chesterfield Engineering Co., 35, West Bars and Park Rd.
 CIRENCESTER.—A. H. Buncombe & Co., 169a, Cricklade St.
 COLWYN BAY.—Ellis Hands & Dean, Ltd., Abergele Rd.
 COVENTRY.—A. Salmon, Drinkwater Arcade.
 DARLINGTON.—E. Sutton & Co., Northgate.
 DARWEN.—W. V. Fairhurst, Wellington Fold, Market St.
 DUNDEE.—Ponsonby & McHardy, 32, Reform St.
 DUNFERMLINE.—James Scott & Co., Inglis St.
 DUNBURGH.—D. G. Watson, 126, Bruntsfield Place.
 EGHAM (Surrey).—Radio Supply Stores, 147, High St.
 EGREMONT (Cumberland).—Egremont Radio Stores, 31, Market Place.
 FERRYHILL VILLAGE.—J. F. H. Banner, The Chemist.
 FOLKESTONE.—T. C. Gilbert, 26, Guildhall St.
 GLASGOW.—Robert Ballantyne, 103½, St. Vincent St. Hunter's Wireless Depot, 73, West Nile St. Archibald Low & Sons, Ltd., 28a, Renfield St. Milligan's Wireless Co., Ltd., 23-25, Renfrew St. R. McAughtry & Sons, 423, Covan Rd.
 GRANTHAM.—White & Sentance, St. Peter's Hill.
 GREENOCK.—J. A. Kinnaid & Co., Ltd., 20, Cathcart St.
 HALIFAX.—Electrical Supply Stores, 11, Fountain St.
 HOLLAND.—Gooische Fotohandel, Kerkstraat, 106, Hilversum.
 HULL.—City Electrical Co., 24, Porter St. Clarke & Graham, 73, Prospect St., E. M. Parsons, 38a, Brook St. J. C. Scarborough, 21, George St.
 ILFORD (Essex).—Cranbrook Sports Co., 91, Cranbrook Rd.
 KETTERING.—Paul Taylor, 147, Stamford Rd., Montague St.
 LIVERPOOL.—John Banks & Sons, 14-18, Duke St. The British Radio Mfg. Co., 9, South Castle St. Pulford Bros., Ltd., 106-110, Whitechapel. C. A. Sutton & Co., 110, Dale St. Taylor Bros., 46, Tithebarn St. Western Wireless Telephones, Ltd., 15, Cheapside, off Dale St.
 LONDON.—Nelson Arnold, 5, Ranelagh Gardens, Barnes. L. Ball & Co., 287, Upper St., Islington. Benetfink & Co., Ltd., Cheapside. E. W. Chamberlain, 106, King St., Hammersmith. Fittings Co., 66, Barbican, E.C.1. Cunningham, Ltd., 169-171, Edgware Rd., W.2. A. W. Gamage, Ltd., Holborn, E.C.1. Keen Wireless Co., 1, Dean Rd., West Faling. London Radio College, 82-3, High St., Brentford. Mann, Egerton & Co., Ltd., 175-177, Cleveland St., W.1. Richard Melhuish, Ltd., 84, Fetter Lane, E.C.4. T. Poore & Sons, 232, High St., Acton. Jones & Noyes, 164a, Railway Approach, Shepherd's Bush, W.14. H. Osman & Co., Ltd., 165-6, Aldersgate St., E.C. Auto Sundries, Ltd., 10a, Lower Grosvenor Place, S.W.1.

Continued on next page.

Continued from previous page.

MANCHESTER.—A. Franks, Ltd., 95-97, Deansgate. A. Franks, Ltd., 12 Victoria St., A. Franks, Ltd., 73, Oxford St. A. Franks, Ltd., 44, Market St. Trojan Electrical Co., 141, Upper Moss Lane, Alexander Rd. The Universal Electric Supply Co., 4, Brown St.
 MIDDLESBROUGH.—Baker Bros., Corporation Rd.
 MONTROSE.—James A. Marnie, 107, High St.
 MORPETH.—J. H. Woodhead, 22, Newgate St.
 NEWBIGGIN-BY-THE-SEA.—E. Watson & Son, 23, Gibson St.
 NEW BRIGHTON (Ches.).—Jenson & McNicol, Wireless Corner, 149a, Seabank Rd.
 NEWCASTLE-ON-TYNE.—Chase Motors Co., Ltd., 43, Groat Market. Jas. Coxon & Co., Ltd., Market St. Devercaux, Moadie & Co., Albion Buildings, St. James St. M. C. Jones & Co., Ltd., 239, Westgate Rd. The Masco Patents Mfg. Co., 56, Grey St. Payne & Hornsby, 6, St. Andrew's Buildings, Gallowgate. Walker's Wireless Supply Co., 31, Westgate Rd. Wilson & Ridley, 161, Northumberland St.
 NEWPORT (Mon.).—South Wales Wireless Installation Ltd., Cambridge Rd.
 NORTH SHIELDS.—Electrical Equipment Co. Kennedy & Scott, 78, Rudyard St.
 OLDHAM.—F. Buckley, 89, Oak Road, Hollins.

OXFORD.—Oxford Wireless Telephony Co., Ltd., 22, Queen St.
 PARKESTONE (Dorset).—E. T. Chapman, Newtown.
 PENARTH (Glam.).—C. W. Davis, 98, Glebe St.
 PRESTON.—A. Lotus, 2, Willbank, Church St. Richard Marsdon & Sons, Ltd., 115, Church St. G. Wilkinson, 152, Church St.
 SHAFTESBURY (Dorset).—W. Holder, 65, High St.
 SOUTHSEA.—Wadham Bros., 89, Palmerston Rd.
 STOCKPORT.—Henry Hollingdrake & Son, Ltd., 65, Princes St.
 STOCKTON-ON-TEES.—T. B. Watson & Son, Ltd., Central Buildings.
 STOKE-ON-TRENT.—T. A. D. Lawton, Brown Edge.
 STRANRAER.—T. W. Macready, 39, George St.
 SUNDERLAND.—H. Binns, Sons & Co., Ltd., 38, Fawcett St. Brantingham Bros., Holmeside. Thos. Hudson, 314, High St. West.
 SWANSEA.—Dan Morgan, 218, Oxford St.
 TUNBRIDGE WELLS.—E. Powell, Ltd., 41, High St.
 ULVERSTON (Lancs.).—J. J. Downward, M.P.S., 5, Market St.
 WARRINGTON.—Economic Electric Co., 64, Sankey St. Hill & Co. (Chemists), Ltd., 62, Buttermarket St.
 WEST HARTLEPOOL.—P. F. Perry & Co., Ltd., 11, Church St.
 WHITLEY BAY.—G. T. Robson, 182-184, Whitley Rd.
 WORTHING (Sussex).—Oates, 77, Rowlands Rd.

If there is a "Polar" Stockist near you, make a friend of him. With our assistance he can give you any advice or technical information you require—gratis.

RADIO COMMUNICATION Co., Limited.

Telephone:
Central 848) (3 lines).

34-35, Norfolk Street, Strand, London, W.C.2.

Telegrams:
Radiocomco, Estrand, London.

REDUCED ADVERTISEMENT RATES "WIRELESS WEEKLY."

During the Summer Months the Publishers of WIRELESS WEEKLY have pleasure in offering REDUCED rates for Display Advertising Space as follows:

ORDINARY POSITIONS.

13 insertions consecutive - £15 per page and pro rata.
 6 " " - £15 plus 5% per page and pro rata.
 1 to 5 " " - £15 plus 10% per page and pro rata.

NEXT MATTER (In columns only).

13 insertions consecutive - £20 per page and pro rata.
 6 " " - £20 plus 5% per page and pro rata.
 1 to 5 " " - £20 plus 10% per page and pro rata.

SCHEFF PUBLICITY ORGANISATION, LTD.

(Advertisement Managers, *Wireless Weekly* and *Modern Wireless*).

125, PALL MALL, LONDON, S.W.1.

Phone—Regent 2440 (2 lines).

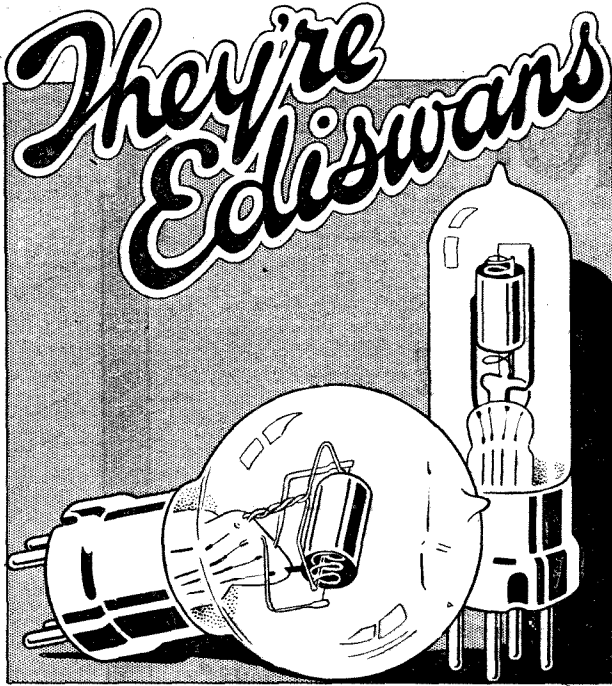

and that's all you need know—because **EDISWAN** means the best valve

The Demonstrator at the Leeds Wireless Club said:

—'no question about **EDISWAN VALVE** taking premier position

REDUCED PRICE

TYPE R.
15/-

COMPACT
ECONOMICAL
RELIABLE

TYPE A.R.
15/-

SENSITIVE
SILENT
ROBUST

We have had unique experience in the development and manufacture of the Thermionic Valve. The first experiments in connection with the investigation of the "Edison Effect," on which the working of a valve depends, were carried out at our Ponders End Works by Prof. J. A. Fleming, who was the Company's Scientific Adviser.

We also manufacture complete Receiving Sets, Accessories and H.T. and I.T. batteries. Dealers should write at once for particulars and terms. Ask for Descriptive Leaflets.

If your Dealer cannot supply, send P.C. with his name and address. We'll see that you get what you want.

FREE ON REQUEST.

Illustrated Booklet entitled "The Thermionic Valve.—Its Origin and Development."

The EDISON SWAN ELECTRIC Co. Ltd.

(AND REDUCED).

Contractors to H.M. Admiralty, War Office, Royal Air Force,

123/5, Queen Victoria Street, E.C.4,
and 71, Victoria Street, S.W. 1.

WORKS: PONDERS END, MIDDLESEX.

Branches in all principal towns



Put Woodhall-Wireless Components in your Set —and you'll be proud of it!

When you are tired of the scraping condenser-vanes, the imitation ebonite, the cardboard, and the unfinished metalwork of the wireless "botcher," you will decide to use only trade-marked, guaranteed components: and of such components, those bearing the trade-mark WOODHALL are outstanding for "finish," efficiency, and price.

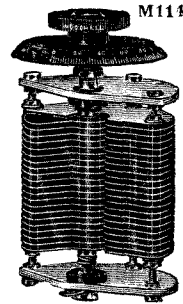

WOODHALL Guaranteed Variable Condensers

Assembled complete as shown, with aluminium end plates and ebonite bushes, for panel mounting. Adjustable bearing, accurate 3/32nd spacing; aluminium 22 gauge vanes; attached to panel by drilling one hole only.

| | | | |
|------------------|-----|-------------------|------|
| 3 plates | 5/3 | 25 plates | 8/- |
| 5 " " " " " " " | 5/6 | 31 " " " " " " " | 8/6 |
| 9 " " " " " " " | 6/- | 43 " " " " " " " | 10/6 |
| 15 " " " " " " " | 6/6 | 57 " " " " " " " | 12/- |

Knob and Dial 1/9 extra.

WOODHALL Guaranteed Moulded Variometers

M 112

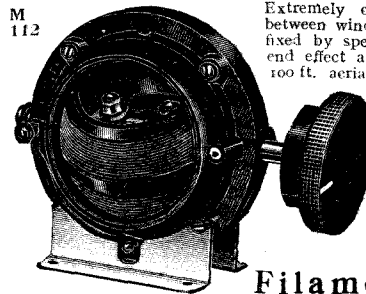

Extremely close coupling (approx. 1/16th between windings). Internal winding firmly fixed by special process. Eliminates dead-end effect and capacity losses. W.L. with 100 ft. aerial, 250/750 metres. For A.T.I. as supplied, or can be used with small basket-coil in series for anode tuning inductance. With massive ebonite knob and terminals, as shown. Brackets movable for panel or table mounting

17/6

The WOODHALL Filament Rheostat

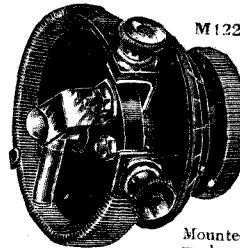

A more efficient rheostat at little more than the price of the old style. Spring plunger contact; smooth and constant. 7 ohms resistance; winding mounted on core; "off" position; two terminals; engraved dial and knob. Attached to panel by drilling one hole only.

5/6

The WOODHALL Dustproof Detector



Mounted on 1/2 in. solid ebonite. Brass-work highly lacquered. Opal back to glass increases visibility. Beautifully finished and very efficient

6/6

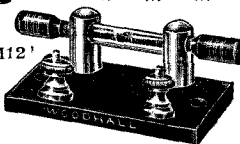

The WOODHALL Perikon Detector

Glass-enclosed; adjustable pressure on crystals and stable setting—resists vibration. Solid ebonite base

3/6

M135

The WOODHALL Lightning Arrestor & Switch

Glass-enclosed spark-gap combined with change-over switch. Perfect contacts, easy movement; ebonite base and highly finished brasswork

6/-

Woodhall-Wireless Components of all kinds are stocked by leading Wireless Dealers and Factors.

Ask your Dealer for Woodhall-Wireless Components. If he does not stock, order direct by post from us; and if you give your Dealer's name and address we supply goods post free. Money back in 7 days if dissatisfied. Quote illustration numbers when ordering.

The Woodhall-Wireless Manfg. Co.,
15, Farnival Street, London, E.C. 4
Telephone: Holborn 5919 Radio Call Letters 2 H P

AMPLION

The Amplion Pedigree

- In 1887.. Mr. Alfred Graham demonstrated the first practical Loud Speaker.
- In 1893.. GRAHAM Loud Speakers placed upon the market.
- In 1894.. First used in the British Navy. Transmitters applied to Phonographs for Loud Speaker reproduction. Demonstrations by Prof. McKendrick at the Royal Society.
- In 1896.. Naval Telephones developed and adopted by the Admiralty.
- In 1898.. Watertight Loud Speakers Patented. Fitted on board many warships and mercantile vessels. Telephonic Submarine Signalling System devised.
- In 1902.. Complete Loud Speaker installations on central battery plan erected on warships as sole means of communication.
- In 1906.. The most extensive naval installation to date, including exchange system fitted to H.M.S. Dreadnought.
- Onwards.. Graham Loud Speakers applied to all sorts and conditions of service at home and abroad, ashore and afloat.
- To 1919.. No less than 12,000 ship installations carried out.
- In 1920.. "AMPLION" Loud Speakers produced for Wireless and "AMPLION" Trade Mark registered.
- In 1922.. "AMPLION" standardised by leading manufacturers of radio apparatus

—the Reason Why the "AMPLION" is undeniably the finest Radio Loud Speaker and recognised as the World's Standard. It will be seen that the "AMPLION" is not merely produced to meet a sudden demand, but is the result of years of experience in Loud Speaker design and construction.

ASK FOR FOLDER M.W.

ALFRED GRAHAM & CO.,
St. Andrew's Works,
CROFTON PARK, LONDON, S.E.4.

Phone: Sydenham 2820-1-2. Grams: "Naval Road, Catgreen, SCOTLAND: London."

Mr. F. M. Milligan, 25, Renfrew St., Glasgow
IRELAND:

Mr. A. R. Munday, 41, Chichester St., Belfast
CANADA:

Messrs. Burndept of Canada, Ltd., 172, King Street, West Toronto.

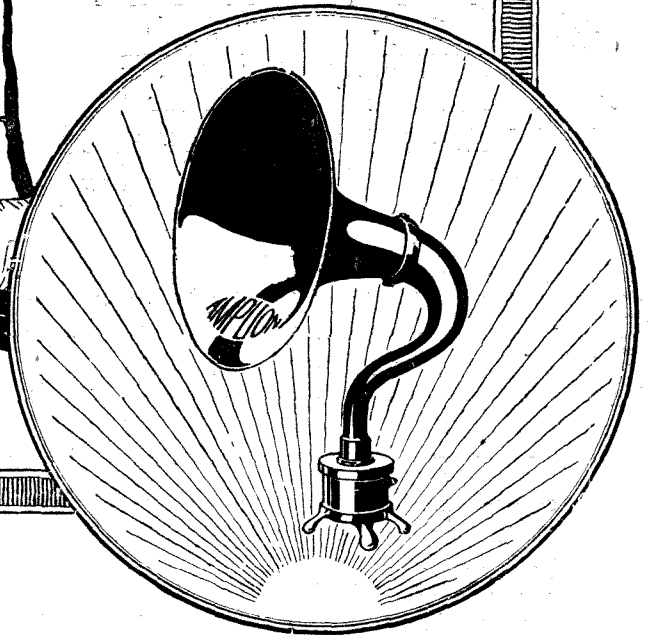

DEMONSTRATIONS at our Showroom:
THE ALGRAPHONE SALON,
25/6, Savile Row, Regent St., London, W.1.
Phone: Regent 1075.

This is the popular Marconiphone V2, which brings all British Broadcasting Stations within range of any part of the country.

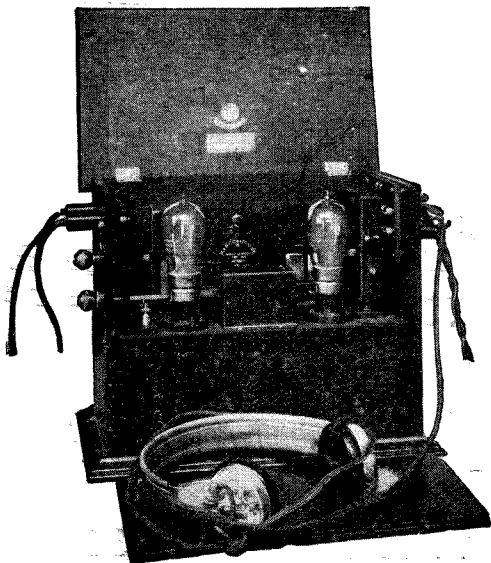

THE MARCONIPHONE V2

The signature "G. Marconi" on the case attests its perfection of workmanship and absolute reliability.

The **Marconiphone**
The Triumph of the Master Mind



Your local dealer can supply you. In case of difficulty apply to:—



MARCONI'S WIRELESS TELEGRAPH COMPANY, LIMITED
Marconiphone Department, Marconi House, Strand, London, W.C.2

RADCOM H.T. BATTERIES.

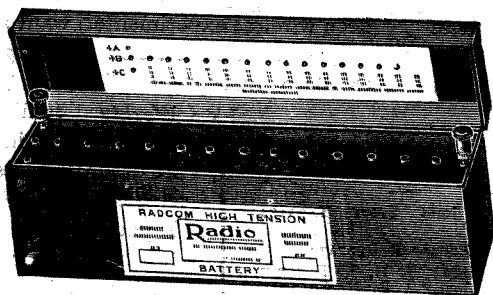

By our new Patented system of connecting these batteries, they have an advantage over all other types of High Tension Dry Batteries, which enables tapings to be made at every 1 1/2 volts, thus giving a variation rendering the finest possible adjustments.

| APPROX. E.M.F. VOLTS. | Price complete with plugs. |
|-----------------------|----------------------------|
| 18 | 4/- |
| 36 | 7/- |
| 63 | 13/6 |
| 126 | 27/- |

RADCOM SHROUDED INTERVALVE TRANSFORMER

ELIMINATING HOWLING AND DISTORTION.

Price - - 22/6

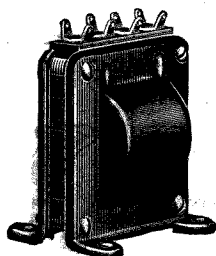

Radio COMPONENTS LTD

19, Rathbone Place, LONDON, W.1.

Telephone: Museum 3485.
Telegrams: Radponents Westcent, London.

MANUFACTURERS OF ACCESSORIES.

THE H. A. H. VARIABLE GRID LEAK.



Perfectly smooth action. Each individually tested before despatch.

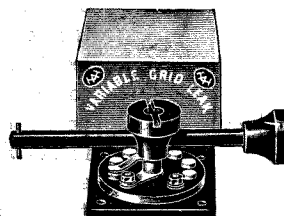

For the S.T.100 Circuit a special model is made.

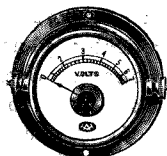

Fig. 1100.—A beautifully made accessory. PRICE 7/6 each. Standard type, 1/2 to 5 megohms. S.T.100 Circuit special model same price.

Extension handle, 1/- extra each.

Fig. 160. **VOLTMETER** Price 9/6 each.

All types and ranges of spring controlled instruments in stock. See Catalogue 50.

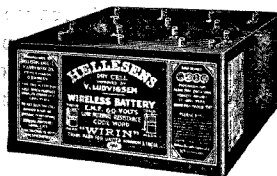

Fig. 136. **VOLTMETER** Price 3/6 each.

Complete range of these DEAD BEAT moving coil types in stock.

GENUINE HELLESEN DRY BATTERIES.

| Codeword. | Volts | Details. | Size. | Price each |
|-----------|-------|--------------------------------|----------------------|------------|
| "WIRON" | 15 | Three Screw Terminals or Plugs | 8" x 1" x 3" | 3/6 |
| "WIRTO" | 15 | Two Strip Terminals | 8" x 1" x 3" | 3/6 |
| "WIRIT" | 36 | Two Insulated Wander Plugs... | 6 1/2" x 2 1/2" x 3" | 8/6 |
| "WIRIN" | 60 | Two Insulated Wander Plugs... | 6" x 5" x 3" | 14/- |
| "WIRUP" | 100 | Two Insulated Wander-Plugs... | 9" x 5" x 3" | 23/- |

Two Wander Plugs, one red and one black, are included in the price as above and are not extra.

For any Special Size, Voltage, or Capacity: made to your own Special Requirements. "Keyage, 2225." A. H. HUNT Ltd. (Department W.E.) Croydon. H. A. H. WORKS, TUNSTALL ROAD, CROYDON, SURREY.



No other Wireless Magazine Staff as *Wireless Weekly*

TO obtain the confidence of its readers, and to achieve complete success, a Wireless Magazine must be in the position to guarantee the accuracy and dependability of the information within its columns. *Wireless Weekly* is supervised by the finest staff of all-round Wireless technical experts in the country. Each department of Wireless is in the hands of a man who has had some considerable experience in dealing with it and who may be considered an expert in that particular phase of the Science. Such an organisation as this is of benefit to you in two ways. Firstly, because it is so complete in itself as to be independent, when necessary, of outside

contributors. Secondly, it is in a position to judge the value of contributions submitted for publication by outside research workers and technical men and able to criticise and correct faults which might otherwise have appeared in print unnoticed. You, as a keen wireless experimenter, want authoritative Wireless articles—thoroughly up to date and dependable. *Wireless*

Weekly fulfils your requirements in a way no other Wireless Magazine ever has or can do. If you have not already become a regular reader, send a postcard at once for a free copy—you will be surprised that such a large and important Weekly Magazine can be produced for so little as sixpence.

EDITORIAL STAFF.

Editor: JOHN SCOTT TAGGART, F.Inst.P.
Assistant Editor: E. REDPATH.
Staff Editors: J. H. T. ROBERTS, D.Sc., F.Inst.P.; E. H. CHAPMAN, M.A., D.Sc.; A. D. COWPER, M.Sc.; G. P. KENDALL, B.Sc.; A. L. M. DOUGLAS; R. W. HALLOWS, M.A.; S. G. RATTEE; PERCY W. HARRIS.
Scientific Adviser: Prof. G. W. O. HOWE, D.Sc., M.I.E.E.
Advisory Editors: Prof. R. WHIDDINGTON, M.A., D.Sc.
 Prof. C. L. FORTESCUE, M.A., M.I.E.E.

Wireless Weekly

Every Wednesday

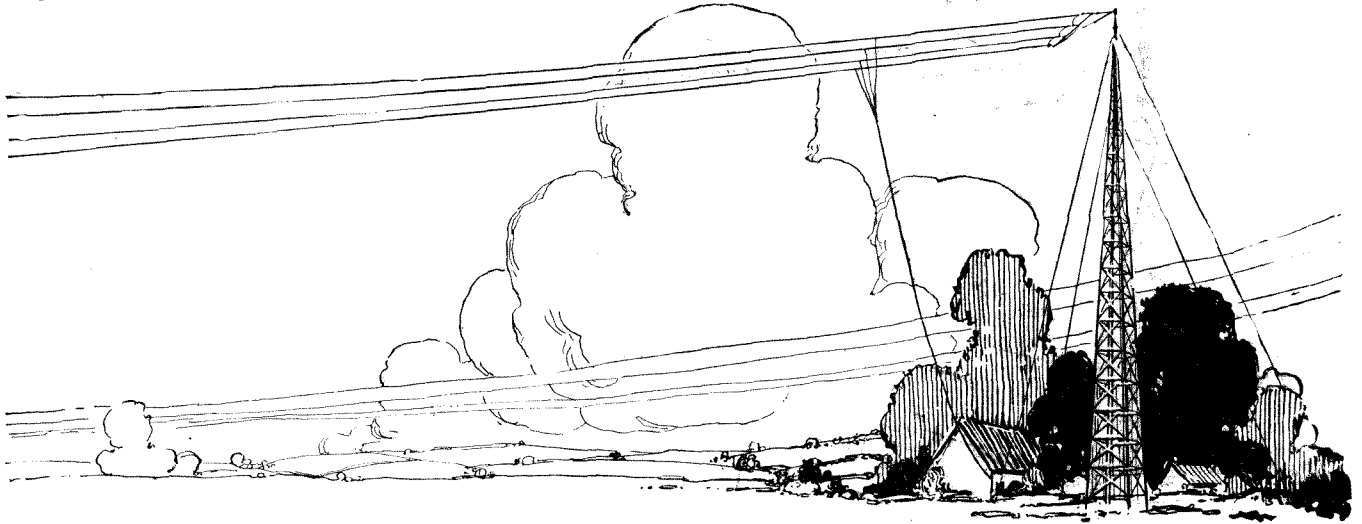

has such a complete Editorial
—read how you benefit.

Recent Constructional Articles.

The following Articles have appeared in recent issues of *Wireless Weekly*. All are thoroughly dependable and illustrated in most cases with actual working drawings, so that even a novice can make up the instruments correctly.

- Construction of a 5-Valve Amplifier.
- A Progressive Unit Receiving System and How to Build It.
- The S.T.100 Set.
- A Compact Single-Valve Receiver.
- The Flewelling Super-Receiver.
- A Low-Frequency Amplifier.
- A Three-Valve Regenerative Receiver.
- A High-Frequency Amplifier.
- The Armstrong Super-Receiver.
- A Variometer Broadcast Set.
- A 2-Valve Broadcast Receiver.

Annual Subscription (52 issues post free), 32/6. Subscribers are permitted the free and unrestricted use of our Information Dept. To others we are compelled to make a charge of 1/- per question. Why not send your subscription along now and ensure your copy arriving punctually?

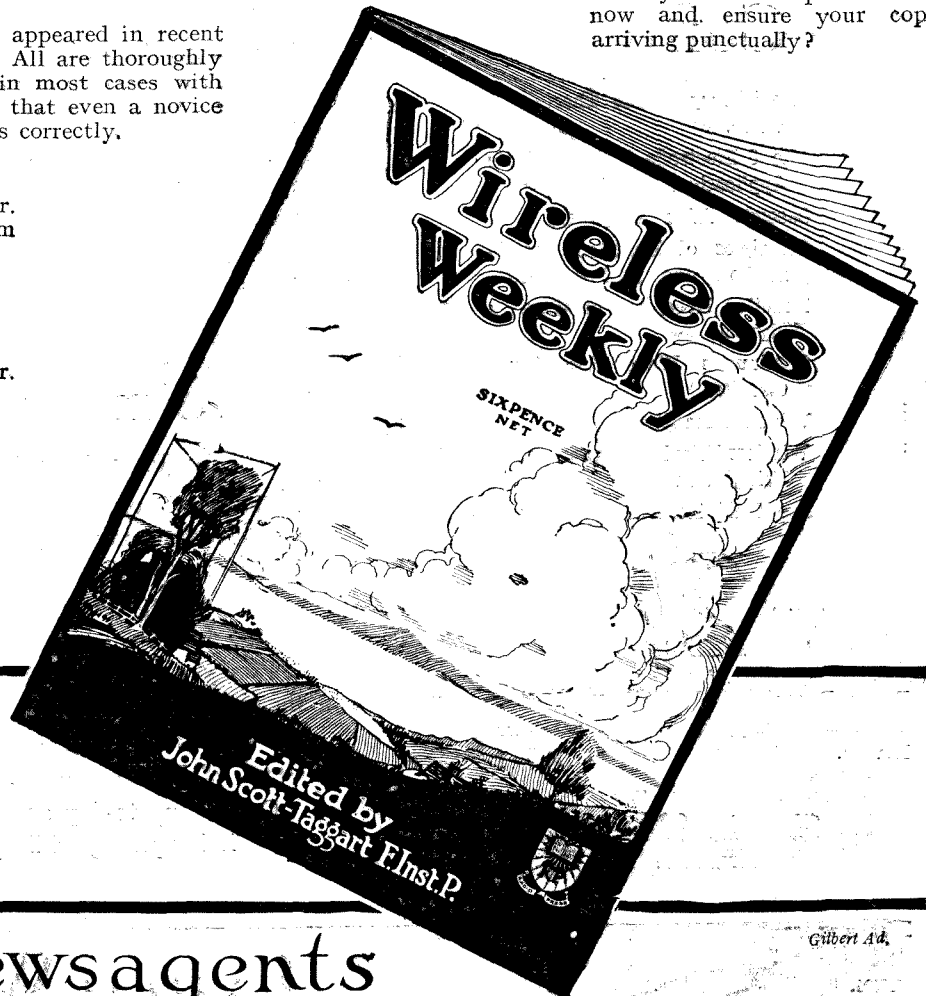

from all Newsagents

Gilbert Ad.

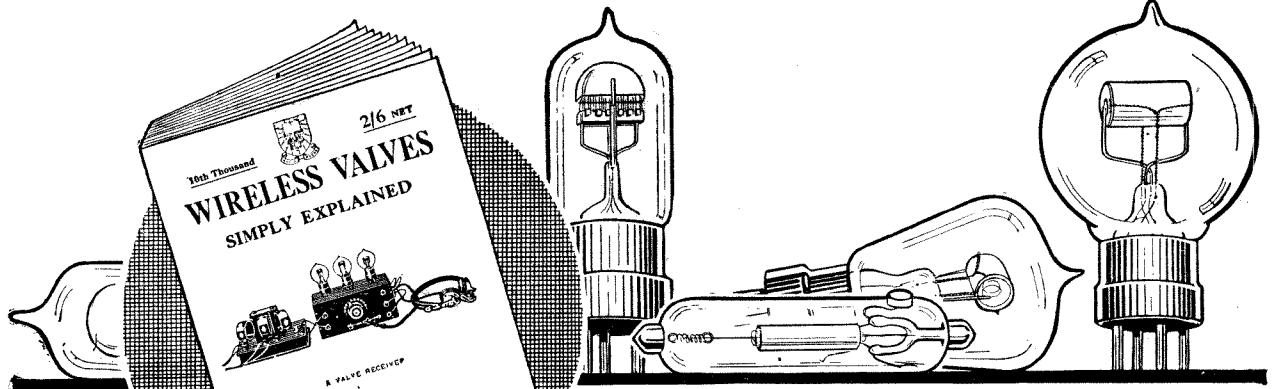

Valves

THE Valve is undoubtedly the most important part of any Receiver. If your Valve (or Valves) is not functioning correctly, you are not getting the best results from your Set.

Before you can hope to become a skilled driver and obtain the most pleasure from your car you must know how it works. So with Wireless. You cannot hope to get the greatest enjoyment from "listening-in" or experimenting until you have mastered the fundamental principles of Radio.

Dependent on this lies your ability to understand the theory of the Thermionic Valve. Know how it rectifies, how it oscillates, and how it amplifies, and your progress in obtaining further Radio knowledge will be rapid.

Wireless Valves Simply explained

By JOHN SCOTT-TAGGART, F.Inst.P.,

is the one Book on the Valve which will really teach you—commencing at the very beginning—everything you need know about the Valve. It has been recognised by all the experts as the standard popular-priced book on the subject.

Purely scientific explanations are omitted because the aim of the author has been to provide a book which, while being absolutely accurate, can be read and understood by novice and experimenter alike.

Get a copy to-day and begin to understand exactly what is happening while your Receiver is working.

Contents

- The Theory of the Thermionic Valve.
- The 3 Electrode Valve and its Applications.
- Cascade Valve Amplifiers.
- Principles of Reaction Amplification and Self-oscillation.
- Reaction Reception of Wireless Signals.
- Continuous Wave Receiving Circuits.
- Valve Transmitters.
- Wireless Telephone Transmitters Using Valves.
- Broadcast Receivers.

2/6

RADIO PRESS' Wireless Library, No. 10.

From all Booksellers or Newsagents, or 2/8 post free.

Radio Press, Ltd.
PUBLISHERS OF AUTHORITATIVE WIRELESS LITERATURE
DEVEREUX COURT, STRAND, W.C.2

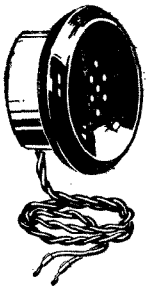

K 9/2

We are Actual Manufacturers and Patentees of
TELEPHONES. LOUD SPEAKERS SETS.
 Special Magnets. High Resistance Coils.
 Home Charging Device for Accumulators.
FIRST COST THE ONLY COST.—CHARGING DONE FREE.

EARTHING CLIPS, ETC.

Being Manufacturers we are able to Guarantee every part. Repairs and Rewinds to all makes of Phones. Phone Parts. Set Parts. Loud Speaker Parts.

K 9/2 PHONE 6/-, Postage 6d.

SIMPALL CRYSTAL SET, with Phone ready for Aerial 10/9, post 1/-
 LOUD SPEAKER, 26in. high, £4 10s. Other goods equally cheap.

Price List Free. Catalogues 1/- returnable on purchase.

TURNOCK'S TELEPHONE WORKS, 41, High Street, Aston, Birmingham.

Catalogues are Illustrated and contain Genuine Workshop Hints to Amateurs.

**Our Improved
 Type All
 CONDENSER
 —for Panel Mounting—**

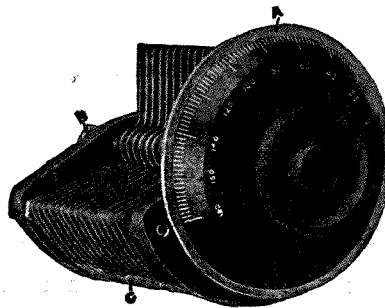

SPECIAL FEATURES.

- A.—Aluminium Screening Disc, which, besides enhancing the appearance of the dial as it lies flush with the panel, prevents the hand of the operator producing capacity.
- B.—Metal to metal adjustable bearings, of which we were the originators, as applied to Condensers.
- C.—22 Gauge hard Aluminium Vanes.

Complete in EVERY respect and exactly as illustrated to the following specification.

Rotary, Air Dielectric, 22 Gauge Aluminium Vanes. Metal to Metal Adjustable Bearings. Spacing between plates sufficient for pressure up to 1,000 volts. Engraved Ebonite Dial. Is suitable for mounting on any Panel up to 1/2 in. thick by drilling three holes. Supplied with screws for fixing.

Most Dealers stock these. If unable to obtain locally buy direct from us.

Don't allow our prices to prejudice you. They are no criterion whatever of the value we offer. Our Motto is **QUALITY FIRST**, and every Condenser carries our money-back guarantee.

| Plates. | PRICES |
|---------|---------------|
| 57 ... | *001 ... 10/- |
| 29 ... | *0005 ... 8/6 |
| 19 ... | *0003 ... 6/9 |
| 13 ... | *0002 ... 5/6 |

Postage and Packing:

1, 1/- 2, 1/3 3, 1/6.
 Most dealers stock these. If unable to obtain locally buy direct from us.

is unsurpassed for Workmanship, Quality of Materials employed, Efficiency and PRICE, which, by the way, has NOT been INCREASED.

Testimonial—one of Hundreds.

Softerley, Wangford, Suffolk, May 20th, 1923.

Dear Sir,—The three .0005 Condensers you supplied me with recently are excellent and equal to some I paid 35/- for. I have never seen better value for money, and I have been an experimenter for years. The points of excellence are—

- (1) Connection to moving plates, although frictional, gives no trouble whatever as in many Condensers.
- (2) Both connections made by nuts and NO loose wire hanging from the moving plate connection as in the case of some, this wire frequently breaking.
- (3) Absolute rigidity.
- (4) Completeness (supplied with dial, etc.).
- (5) LAST—but not least—PRICE. This letter is entirely unsolicited, and you can make any use you like of it and my name.

Yours truly, A. E. D. KENNARD.
 Wireless Officer in France and Instructor at R.A.F. School of Wireless during the War.

ALL ORIGINALS CAN BE INSPECTED.

REPUTATION—Your Condenser is not a "FALLON" unless the name "FALLON" appears on same.

WARNING! Don't buy shoddy sets of Condenser parts which are well-nigh impossible of assembly, or half assembled Condensers which are merely thrown together. **BUY OURS—** we specialise in Condensers Complete in every respect and exactly as illustrated.

In response to numerous enquiries we beg to state we manufacture Variable Condensers only.
PROMPT DE-LIVERY. CASH WITH ORDER.

FALLONS
 THE CONDENSER PEOPLE

PROMPT DE-230a, HERMITAGE ROAD, LONDON, N.4.
 Finsbury Park, near the Manor House.

AGENTS:—London, W.C.2—Vanstones Ltd., 61, Chandos Street, Cardiff and District—Western Radio Co., 52, Bedford Street, Cardiff.

ON CONDENSER MFG. CO., LTD. Makers of half the World's Variable Condensers.

FALL

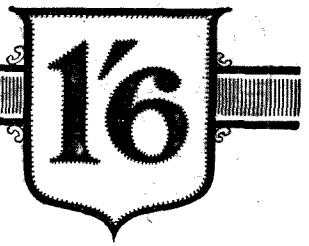
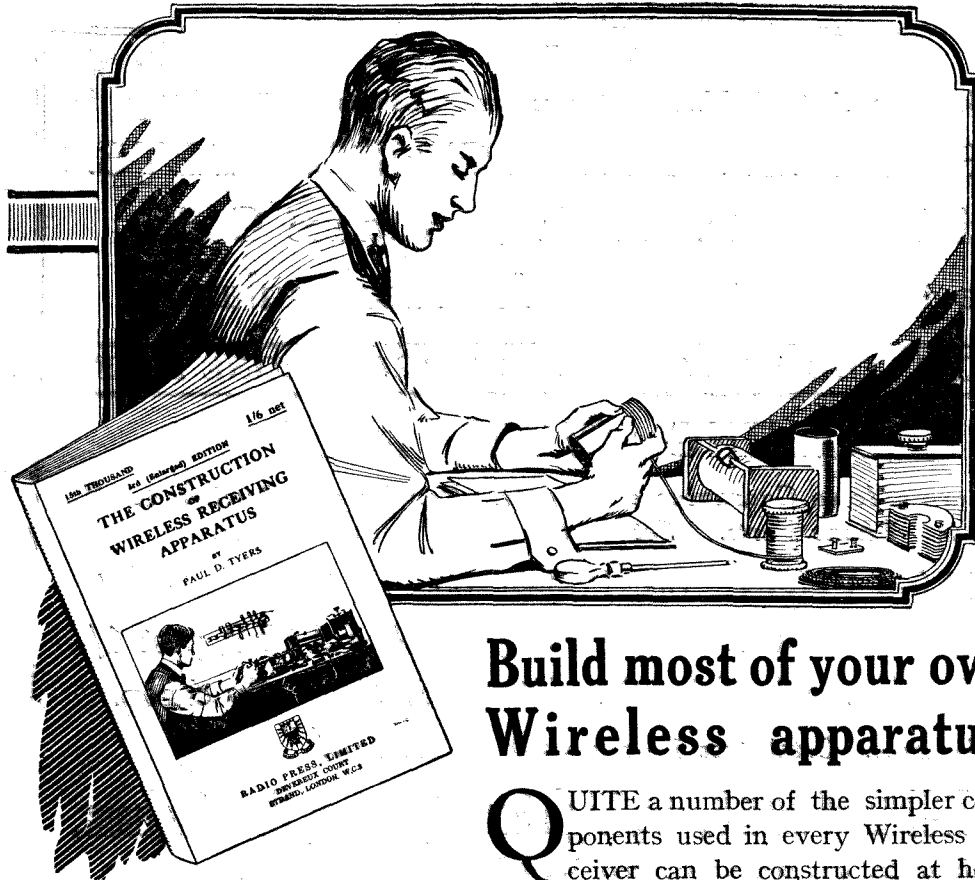

Sold by all Book-sellers and News-agents or 1/7½ post free.

Build most of your own Wireless apparatus.

QUITE a number of the simpler components used in every Wireless Receiver can be constructed at home by anyone without the necessity of special tools or skill.

This little Book contains practical instruction in the making of these components and shows by diagrams exactly how each is made. In addition, full details, such as gauge of wire to be used, number of turns, etc., are invariably stated.

Every description is accurate and is the result of the author's own experiences.

If you are a beginner you will appreciate this Book because it shows you many short cuts in saving money, while if you are a seasoned Experimenter you'll value it because its information will show you how to add and improve your Set at little cost. Get a copy to-day—it will save its cost on the first piece of apparatus you make.

RADIO PRESS, LTD.
Devereux Court, STRAND, W.C.2

"The Construction of Wireless Receiving Apparatus,"

By P. D. TYERS.

5th Edition. 96 Pages.

RADIO PRESS, LTD.,
Devereux Court,
STRAND, W.C.2.

SHOWS YOU HOW TO BUILD YOUR OWN —

- Anode and Grid Resistances.
- Filament Rheostats.
- Potentiometers.
- Basket Coils.
- Slab Coils.
- Solenoid Coils.
- Duolateral Coils.
- H.T. Batteries.
- Condensers.
- Crystal Detectors.
- L.F. Transformers.
- H.F. Transformers.

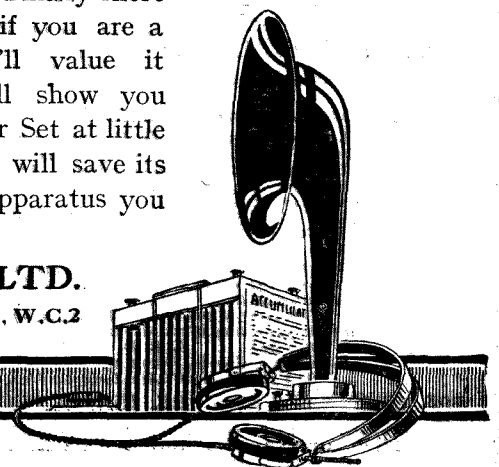
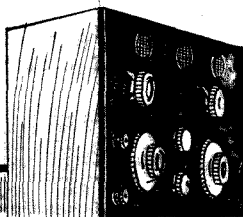

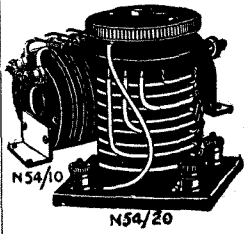

HIGH FREQUENCY INTER-VALVE TRANSFORMERS.

Wave length 360-3200 Meters. Suitable for Panel mounting. Plug-in Type to fit the Standard Valve Socket. Fitted with 4 point Double Pole Switch No. N54/500, 30/- Mounted on Ebonite Base with Terminals marked for respective connections and fitted with a 4 point Double pole Switch, No. N54/20, 32/6.

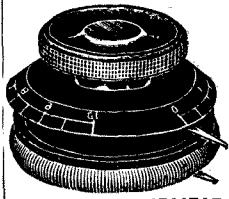

FILAMENT RHEOSTAT. Best finish, 2/6. As illustrated, with Engraved Dial 3/6.

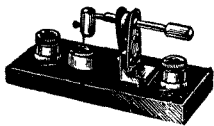

CRYSTAL DETECTOR. Mounted on Ebonite Base, fitted with Ball Joint, 2/6.

FIXED CONDENSERS. Various capacities, complete with Clips, 2/6. Grid Leak and Condenser, mounted on Base, as illustrated, 6/-, Grid Leak with Clips, 2/6. Anode Resistance with Clips, 2/6.

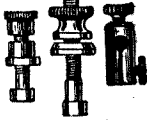

TERMINALS & STAMPING. at competitive prices. Wide range see List.



SYLKOFLEX

The most perfect insulating varnished Tubing for back of panel Wiring in variety of colours. Samples and prices on request.



We invite Trade applications for our Illustrated Catalogue of Wireless Broadcast Reception Sets and Components of every description. Enclose business card for special terms and discounts.

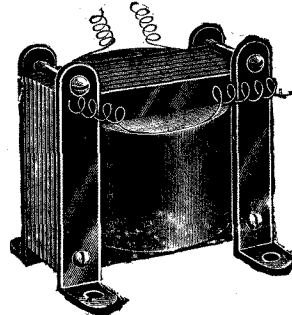

LOW FREQUENCY TRANSFORMERS.

Super-efficient, high grade finish, with loose wires for Panel Mounting, as illustrated, price 16/6. Complete, fitted with Terminals, price 18/-.

AERIAL WIRES

Our Chain Braid Aerial Wire affords the maximum reception, surface greatly increasing signal strength. 3/- 100 ft.



WIRELESS RECEIVERS BRITISH MADE.

Single Receiver, fitted with long handle. Particularly designed for ladies' use, excellent finish, easy fitting, loud and clear, 2,000 ohms. Complete with Cords and stamped B.B.C., price 15/-, Double Head Receivers, 4,000 ohms, complete with Cords and stamped B.B.C., price 21/-.

WOUND INDUCTANCE TUBES.

- 6 by 3 ins. ... 1/10
 - 6 by 4 ins. ... 2/-
 - 12 by 3 ins. ... 3/3
 - 12 by 4 ins. ... 3/6
- Other sizes on application.

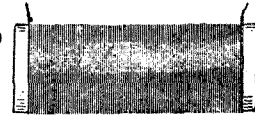

SELECTED CRYSTALS.

"Myronite," the Super Crystal, gives surprisingly good results. 1/6 per box. We stock a wide range of Crystals, including Bornite, Galena, Hertzite, Zincite, Carborundum, etc.

AERIAL INSULATORS.

Immense stocks of Aerial Insulators at right prices. See Catalogue



NEW CIRCUITS

are a speciality of "Modern Wireless." Components for these circuits are a speciality of ours. "Efficiency" Inductances should be used on all these circuits to ensure the best results. Try them on the ST 100 and judge for yourself.

All other components are also made by us, and backed by 30 years' experience.

Double Plug and Plug and Socket. Coil Leaflet on request. Complete Catalogue, 6d., post free

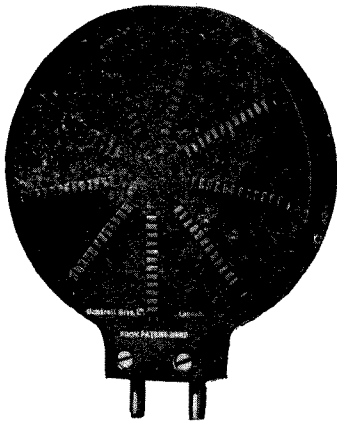

Gambrell Efficiency Inductances.

| | On 100 feet P.M.G. Aerial with .00065 Microfarad Maximum Condenser. | | | | Secondary Circuit with .00025 Microfarad Maximum Condenser. | | Self-Capacity of Coil Microfarads. | Price. |
|---|---|------|-----------|-------|---|-------|------------------------------------|--------|
| | Series. | | Parallel. | | | | | |
| | 110 | 165 | 205 | 320 | 66 | 175 | .000003 | 5/9 |
| A | 175 | 260 | 325 | 510 | 105 | 275 | .000004 | 5/9 |
| B | 275 | 415 | 495 | 825 | 170 | 440 | .000005 | 6/- |
| C | 380 | 530 | 690 | 1150 | 240 | 610 | .000006 | 6/9 |
| D | 530 | 750 | 975 | 1625 | 340 | 880 | .000006 | 8/- |
| E | 880 | 1200 | 1600 | 2700 | 575 | 1500 | .000008 | 9/6 |
| F | | | 2550 | 4200 | 890 | 2303 | .000009 | 10/3 |
| G | | | 3650 | 6200 | 1350 | 3500 | .000011 | 12/- |
| H | | | 5800 | 10000 | 2000 | 5200 | .000014 | 14/- |
| I | | | 9300 | 14000 | 4000 | 8000 | .000017 | 16/- |
| J | | | 13700 | 25000 | 6000 | 13500 | .000021 | 19/- |

Set of Coils A-H, £3 10 0.

GAMBRELL BROS., Ltd., 76, VICTORIA ST., S.W. 1. Phone: Victoria 9938. Works: SOUTHFIELDS.

An Experimenter's Licence is well worth having.

**This is what
the P.M.G. said**

"In order to ascertain my position I felt it my duty to place the whole facts before the Law Officers of the Crown, and I have just received the opinions of the Attorney-General and the Solicitor-General.
These are that I am not only entitled, but compelled by law to issue an Experimenter's Licence to those applicants in regard to whom I am honestly satisfied that they are genuine experimenters.
This being so, while it would be wrong to issue an Experimenter's Licence to the man who is obviously merely a broadcast listener-in, it would be equally wrong to decline to issue such licences on a wholesale scale."

To a Representative
of the Press.

UNDOUBTEDLY a very large number of wireless enthusiasts are contravening the present regulations regarding licences. Some through ignorance, others wilfully because their applications for Experimental Licences have been turned down.

If you are a genuine Experimenter, prepared to take up Wireless as a serious hobby and not merely as a means of passing a pleasant hour in listening to broadcast Concerts, then you are **entitled** to an Experimenter's Licence.

Many applications for Licences have been turned down by the authorities because the applicants were not fully aware of the necessary requirements which had to be fulfilled.

This little book by E. Redpath (assistant Editor of Wireless Weekly) has been written to explain exactly what an Experimenter should know and how he should set about obtaining his Licence.

Remember this important point—even if a Constructor's Licence is issued, it is practically certain to contain special restrictions regarding the use of Receiving Sets and Circuits. With an Experimenter's Licence your work is practically unhampered. Why not get a copy of this book to-day and legalise your position at once and for always?



Gilbert Ad.

RADIO
PRESS
Series
No. 11.

Radio Press, Ltd
PUBLISHERS OF AUTHORITATIVE WIRELESS LITERATURE
DEVEREUX COURT, STRAND, W.C.2.

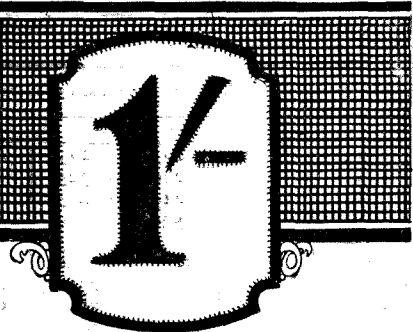

From all Booksellers
& Newsagents, or 1/1½
post free direct.

**BRING THE STARS
OF OPERA TO YOUR HOME**

BUT hear them through **Ericsson** 'Phones—every voice-modulation, every intake of breath, every liquid note of the tenor or soprano, unspoilt by distortion—too common a 'phone fault.

Prices 31/- 2,000 ohms, 32/- 4,000 ohms.

Write to-night for Free List.

The **BRITISH L.M. ERICSSON MFG. Co.**,
International Buildings,
67/73, Kingsway,
London, W.C. 2.

Ericsson
Telephones



Look for these marks when buying Ericsson Telephones

Selling Agents
Scotland: 57, Robertson St., Glasgow.
Newcastle-on-Tyne: Milburn House.
Manchester: 105/107, Corporation Street.
Nottingham: W. J. Furse & Co., Traffic Street.
Birmingham: 14/15, Snow Hill.

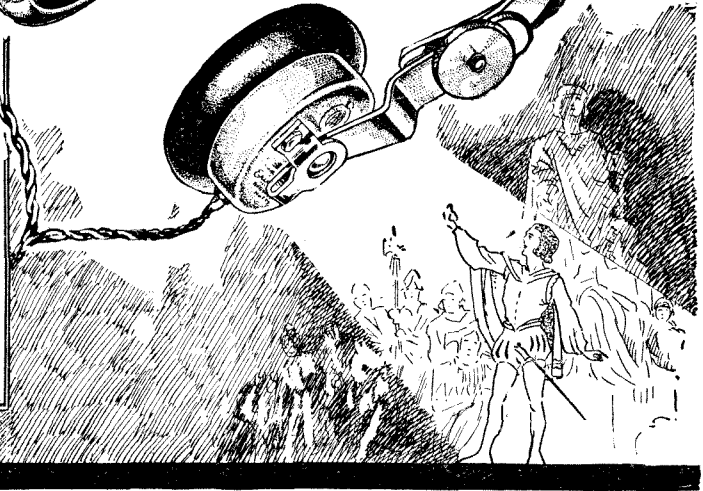

NEGRETTI & ZAMBRA

H. F. TRANSFORMER

Tapped primary and secondary; range 150-25,000 metres

50/-

Latest Price List of Wireless Apparatus forwarded on request. Send your enquiries to—

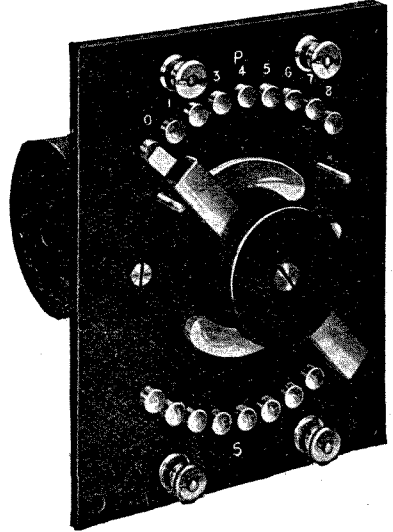

NEGRETTI & ZAMBRA

Wireless Department,
38, HOLBORN VIADUCT, LONDON.

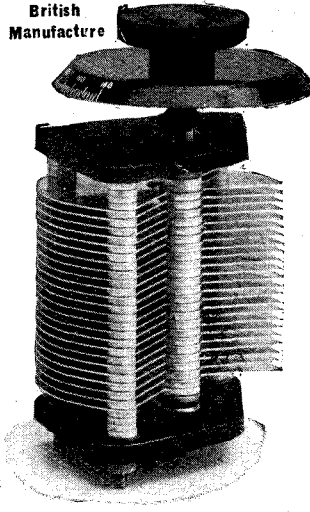

THE J B

Precision Variable CONDENSERS

get the **BEST RESULTS** Guaranteed up to specified capacity.

The ACME of PERFECTION SCIENTIFICALLY DESIGNED and no **PANEL** can be **UP TO DATE** without them.

Completely assembled with **KNOB and DIAL.**

ONE HOLE only for **FIXING to PANEL.** Large **METAL to METAL BEARINGS.**

By their use **BIG IMPROVEMENTS** can be made at **SMALL COST.**

UNSOLICITED.
Original can be inspected at our office. JUN 23 1923. LON P.N. E. 17.
Dear Sirs, It will be of interest to you to know that I have tested the 12 Variable Condensers bought from you of your make. Types '001 to Vernier. The Condensers came through the test with very satisfactory results, being of the Capacity specified. It is with pleasure I write these few lines to congratulate you on the excellent results.
Yours faithfully,
A. W.—A.M.I.E.E.

| | |
|---------------|-----|
| '001 | 8/6 |
| '0075 | 8/- |
| '0005 | 7/- |
| '0003 | 5/9 |
| '0002 | 5/- |
| VERNIER | 4/- |

Packing and Postage extra.
One only, 9d. Two, 1/-.

Obtainable through your dealer or direct from:—

JACKSON BROS.

Condenser Specialists,
(First Floor), 8, POLAND ST., OXFORD ST., LONDON, W.1. TRADE ENQUIRIES INVITED.

Phone: Gerrard 6187.

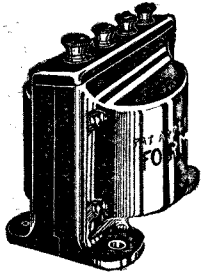

The **Formo** Shrouded Transformer. A really high-class instrument, fully guaranteed. Free from noise. Stray fields and interaction on multi-valve, etc. eliminated. There is nothing better at any price. Is highest value obtainable at

18/-

Factors are invited to apply for list of districts still vacant. **Traders are invited to apply for terms.**

Send stamp for illustrated list B 22. When ordering send ample postage, any excess returned immediately.

Also obtainable from all Traders of **REPUTE**, or direct from—

The FORMO Company.

Offices & Works—
22, Cricklewood Lane, N.W.2.

Demand FORMO Products

Your Dealer **CAN** supply them. **A HIGH STANDARD OF EXCELLENCE IS RIGIDLY MAINTAINED.**

Other Guaranteed FORMO LINES:

THE FORMO VARIOMETER (Broadcast). Machined Spindle and Bush, 250-6com., with 8/- Base, without 5/6 Base.

THE FORMO RHEOSTAT Mechanically Perfect, approx. 5.5 ohms., 2/6

NEVER buy a rheostat which has merely a piece of screwed rod as a spindle.

THE FORMO DUAL CUP CRYSTAL DETECTOR, with new universal joint, which has superseded the old ball and sleeve. Instantaneous and permanent adjustment, 2/6, instrument finish.

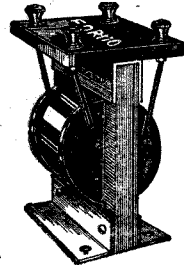

The **FORMO** Standard Transformer, L.F.I.V. or Telephone. **THE MOST WIDELY USED TRANSFORMER**, backed by the **FORMO** guarantee, 15/-, ratio 4-1.

VARIOMETERS

WAVE LENGTH 340-560 Metres.

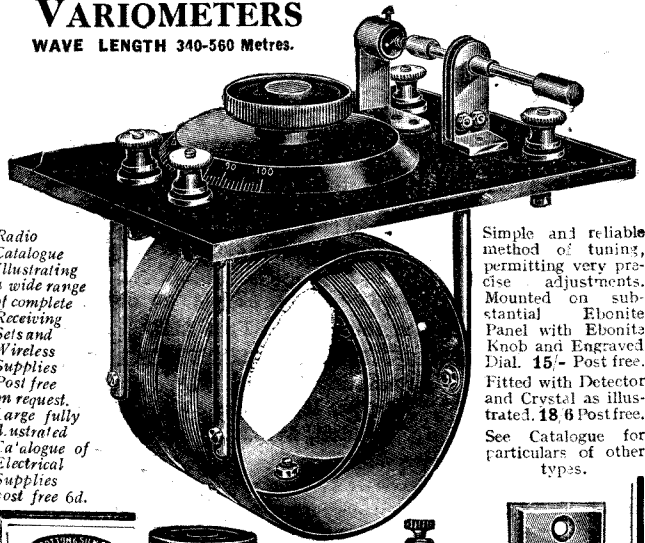

Radio Catalogue illustrating a wide range of complete Receiving Sets and Wireless Supplies Post free on request. Large fully illustrated Catalogue of Electrical Supplies Post free 6d.

Simple and reliable method of tuning, permitting very precise adjustments. Mounted on substantial Ebonite Panel with Ebonite Knob and Engraved Dial. 15/- Post free. Fitted with Detector and Crystal as illustrated. 18/6 Post free. See Catalogue for particulars of other types.



SILK, COTTON & ENAMELLED WIRES.

Lowest Prices. Prompt Deliveries. Send your Enquiries.

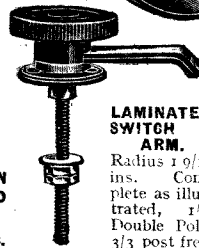

LAMINATED SWITCH ARM.

Radius 1 9/16 ins. Complete as illustrated, 1/9. Double Pole, 3/3 post free.

Make your own H.T. Batteries: Terminals to fit spring contacts on Pocket Lamp Batteries 1d. each. Post free in doz. lots.

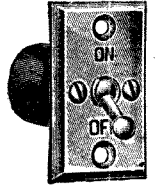

PANEL SWITCHES. Size 1 5/8 by 1 in. Highly finished. Perfectly reliable. All free in doz. Black finish Pull and Push type 2s. 9d.; Tumbler type 2.9d. Nickel finish 3d. extra. Post free.

THE UNIVERSAL ELECTRIC SUPPLY CO., LTD.,
4, BROWN STREET, MANCHESTER.
G.P.O. Box No. 519. Established 1892.

R.E.C. Headphones



4,000 OHMS

25/6

Subject.

"By Test the Best."

TYPE A2.

8,000 OHMS

27/6

Subject.

R.E.C. HEADPHONES are positively the very **best value** on the market to-day. Each instrument is tested and carries our guarantee for absolute reliability. Try these instruments on your set and note the difference. Illustrated Price List of R.E.C. Specialities and trade terms on application to the **Manufacturers**

THE RADIO EQUIPMENT COMPANY, LTD.,

Offices and Demonstration Rooms—

329, High Holborn, London, W.C.1.

Telephone: Holborn 1229, Telegrams: "Exportation, Holb, Ldn."

B.B.C.

WIRELESS DRY BATTERIES

For **B.B.C.** Sets

No. 1 W.

Standard Pocket Lamp Size—4½ volt with patent spiral wire terminals and plug sockets to take Wander Plugs.

Note:— 1 doz. = 54 volts.

Used units replaced easily.

Connect as illustrated.

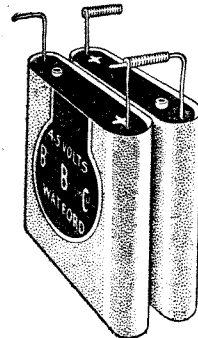

To connect in Series insert straight Terminal in Spiral of next battery. Bend spiral and thus ensure permanent electrical connection without soldering.

BRITISH MADE.

Patent applied for.

PRICE CARRIAGE PAID, 7/- PER DOZEN, WITH PLUG.

Standard Sizes:

| | |
|---|----------------|
| No. 2 W. Slab, 10½ volts, 3-volt tappings. Size approx. 9 x 1 x 3 ins. ... | Price 3/- each |
| No. 4 W. Slab, 36 volts, 3-volt tappings. Size approx. 10 x 1½ x 3 ins. ... | " 6/6 " |
| No. 5 W. Block, 60 volts, 3-volt tappings. Size approx. 9½ x 3½ x 3½ ins. ... | " 12/- " |

Prices include Wander Plug.

Manufactured by

Telephone: Watford 617.

The BRITISH BATTERY CO. LTD.
CLARENDON RD, WATFORD, HERTS.

Radio Rheostats built by Rheostat Specialists

For Detector and Amplifying Valves.

MULTI-STEP CONTROL—giving minute gradations of resistance minimising any tendency to "click" or "sound" in the receivers.

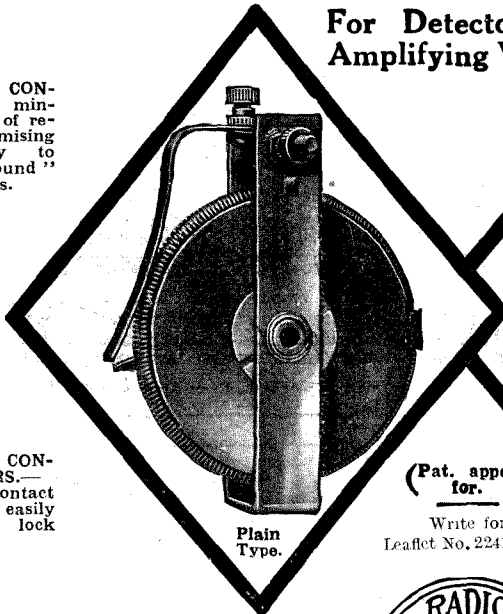

Plain Type.

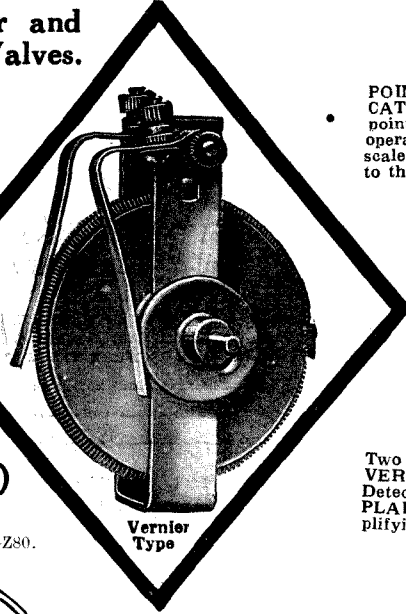

Vernier Type

(Pat. appd. for.)

Write for Leaflet No. 2241-Z80.

POINTER INDICATING.—Nickelled pointer travels over a scale scribed or fixed to the panel.

ADJUSTABLE CONTACT FINGERS.—Tension on contact fingers may be easily adjusted with lock nut.

Two types provided. **VERNIER TYPE** for Detector Valves, and **PLAIN TYPE** for amplifying valve.



Manchester—30, Cross Street.
Birmingham—73-4, Exchange Bldgs.
Glasgow—50, Wellington Street.

149, Queen Victoria St., LONDON.

Cardiff—Western Mail Chambers.
Bradford—18, Woodview Terrace, Manningham.
Newcastle—90, Pilgrim Street.

Works: Elstow Road, BEDFORD.

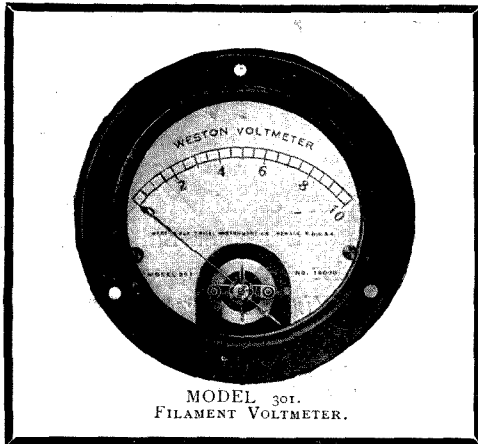

MODEL 301. FILAMENT VOLTMETER.

The WESTON Filament Voltmeter

For Receiving Sets.

MODEL 301.

Simplified tuning by eliminating guesswork as to valve adjustments. Filament voltage control increases the life of the valve from two to three times. The Weston Filament Voltmeter is accurate and can be relied upon for duplication of results.

ALL THIS MEANS BETTER RECEPTION!

List Price £2 : 9 : 0.

WESTON ELECTRICAL INSTRUMENT Co., Ltd.,
Audrey House, Ely Place, Holborn, E.C.1.

Telephone: Holborn 2029. Telegrams: "Pivoted, Smith, London."

The popular

RADION EBONITE DIALS

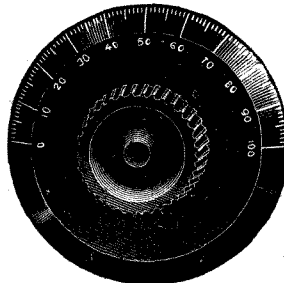

3in. diameter.

These dials are highly polished, have a $\frac{1}{8}$ in. shaft hole, set-screw for fixing dial to shaft, and groove on underside for panel stop pin. All genuine Radion dials are stamped "RADION."

Obtainable from Radio Dealers.

Large stocks of Ebonite Sheet, Rod, Tube and Mouldings.

AMERICAN HARD RUBBER CO. (Britain) LTD.

13a, Fore Street, London, E.C.2.

Telephone: 12754 Central.

Telegraphic Address: "Eboniseth, Ave., London."

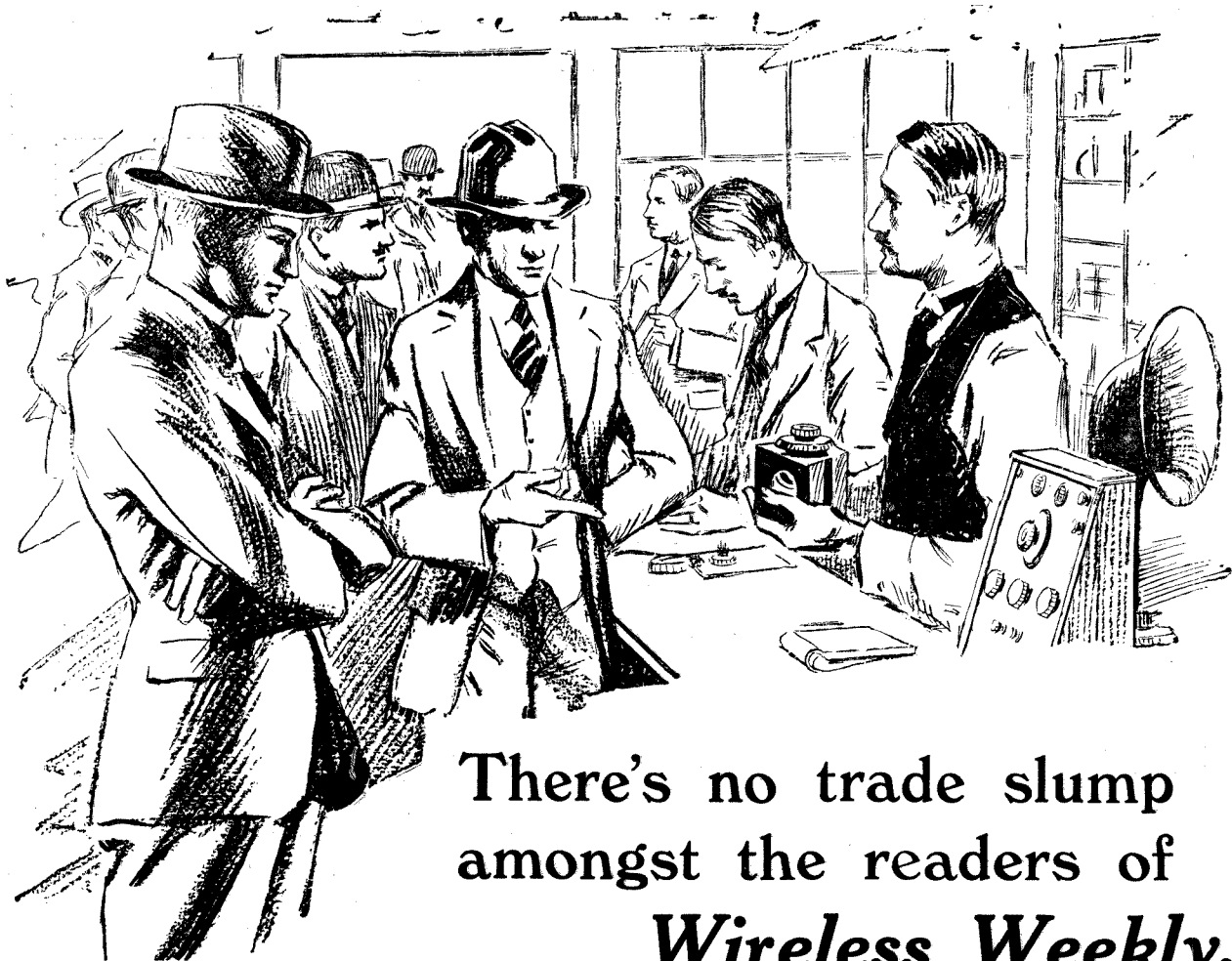

There's no trade slump amongst the readers of **Wireless Weekly.**

Advertisement Rates:—

£15 per page and pro rata

(Ordinary position) for a series of 13 consecutive insertions; 5 per cent. extra for a series of 6 consecutive insertions; 10 per cent. extra for single insertions.

£20 per page and pro rata

(Special positions) for a series of 13 consecutive insertions; 5 per cent. extra for a series of 6 consecutive insertions; 10 per cent. extra for a single insertion.

IF you are a Manufacturer creating a demand for your Radio products or a Dealer building up a good steady Mail Order business, you must regularly use the columns of *Wireless Weekly*.

Wireless Weekly is read by the very best type of Wireless enthusiast. Obviously, the man who is a regular reader of this fine sixpenny Weekly places quality before mere price.

He is in a class by himself. He is not merely a passive user of a Broadcast Receiving Set—rather is he a constant buyer of components, valves, phones, batteries, loud speakers, variometers, transformers, and so forth.

His Receiving Set is always being altered and improved upon and new

ideas incorporated. If you have anything new in Wireless to offer, advertise it in *Wireless Weekly*—the response will surprise you.

In the present difficult times, when trade has slumped and buyers are few, the backbone of the industry is the experimenter, the man who is a prolific spender on his hobby.

Remember, five experimenters out of every six are reading *Wireless Weekly*. If, therefore, you want to reach this splendid class of customer, advertise in *Wireless Weekly*.

Wireless Weekly
— a real business-getter!

All enquiries for space to:—SCHEFF PUBLICITY ORGANISATION, LTD., 125, Pall Mall, S.W.1.

THAMES 2-VALVE REACTION RECEIVER

£7 15 0

B.B.C. tax
paid.

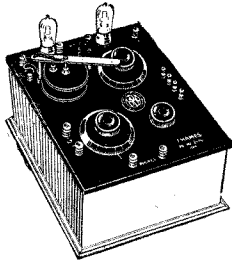

£7 15 0

Marconi
royalties paid.

Wonderful Value, Perfect Reception, Splendid workmanship. Complete with accessories (less valves) 11 Guineas. Write for free list of other sets and accessories to—

THAMES ELECTRIC WIRELESS CO., Ltd., 40, Old Town, Clapham, S.W.4
*Phone: Battersea 1156.

Shoes that become trusty friends

Wearers grow to like Norwell Shoes more and more as the months of service pass—their good quality appearance is a true index to the thoroughly sound character of their make-up.

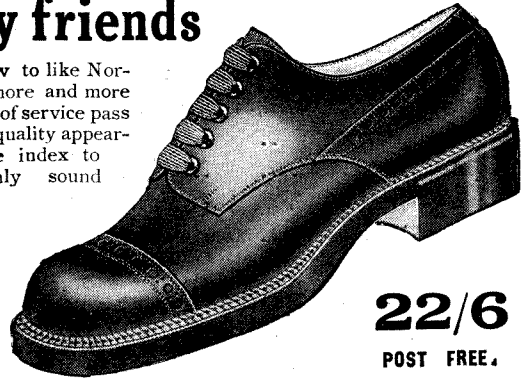

22/6

POST FREE.

May we send you a shoe on approval that you may judge for yourself of the extraordinary value afforded in Norwell shoes? A single shoe is gladly sent on approval, anywhere in Great Britain, on receipt of 9d. to cover postage. When ordering state size usually worn and if convenient send a pencil outline of the stockinged foot obtained by running pencil around foot resting lightly on paper.

"THE LOGHINVER."—Style G6. One of our newest designs in gents' walking shoes, neat and gentlemanly in cut and appearance. Uppers of good selection, Black or Brown Calfskin, bottomed with welted soles of good substance. Beautifully lasted and finished.

THE NORWELL GUARANTEE. Money refunded in full should purchasers not be entirely satisfied

**Norwell's
'Perth' Brogues**

"Direct from Scotland."

Write for new illustrated catalogue showing designs for all purposes, to

NORWELL'S 'PERTH' FOOTWEAR LTD.
PERTH, SCOTLAND.

Mention "MODERN WIRELESS." © M.W.L.



AMATEUR CONSTRUCTORS!

We Supply Everything.

This tuner has been tested and found very efficient as A.T.1 or Anode Tuner for the new S.T. 100 Circuit. H.F. Resistance Coupling, 50,000 to 100,000 ohms, cartridge type, with brass clips, 1/6.

Tapped inductances are far in advance of any other tuning, providing the tappings are correctly arranged. Our tuning inductances are wound on specially impregnated 4in. tubes with 26 s.w.g. double coat on-covered copper wire in the following ratio: 30 sections of 10 turns each, and 10 sections of 1 turn each. This winding will tune from 200 to 1,000 metres. Price 3/6.

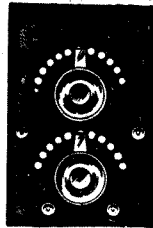
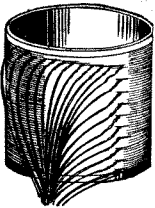

Ebonite panels or the tapped inductances, 7in. by 5in. by 3/16in. drilled for 2 sets of 11 each contact studs and terminals, complete with 22 studs, 2 switch arms, complete, 2 phone, earth and aerial terminals, and blue print of connections. Price 7/- Polished Mahogany sliding front Cabinet for above panel, Price 6/- The Coil and Panel make a most efficient tuner for Crystal or Valve.

P. H. BOYS & CO., Electrical and Wireless Engineers, 187, GOSWELL RD., LONDON, E.C.1

*Phone: Clerkenwell 4454.

VARIOMETERS

for "Modern Wireless" Circuits. Undoubtedly the most efficient method of economically tuning aerial. Ebonite Ball Rotor of most approved design, positive connection to ebonite stator. Wave-length range on 100 ft. "P.O." aerial, 300-700 metres. Gives a very tight coupling, equal in finish to instruments at £1 or more. Secured to panel by simply drilling 3/8-in. clearance hole.

Price 8s. 11d. each. Postage 1s. extra.

VARO-COUPERS.

As above, but wound for use as tuned anode coil and reactance, A.T.I. and reactance, etc.

Price 8s. 11d. each. Postage 1s. extra.

L.F. TRANSFORMERS.

Finest value yet offered. Unusually free from distortion and parasitic noise. Laminated Stalloy Cores. Wound on ebonite bobbins with silk-covered wires. Fitted with terminal mounts. Ratio 4 to 1.

This instrument is not to be classed with similar-priced competition lines. Results and finish are remarkable. Extraordinary amplification. Insulation tested at 1,000 volts. Correct impedance for average "hard" valve. Will safely stand 25 m.a. current without unduly heating.

Price 14s. each. Postage 1s. extra.

All Goods 7 Days' Free Approval against Cash and Dispatched within 24 hours.

ECONOMIC ASSEMBLIES,

Showrooms and Works: 18a, Upper Talbot St. BLACKPOOL

Send P.C. for Comprehensive List. TRADE SUPPLIED.

INTERVALVE

A MODEL INSTRUMENT OF GREAT EFFICIENCY

A Customer writes:

Dear Sir,— You will be interested to know that your L.F. Transformers have given better results than all others I have tested, and I have decided to fit them solely to my instruments. Please find enclosed order for a further quantity.

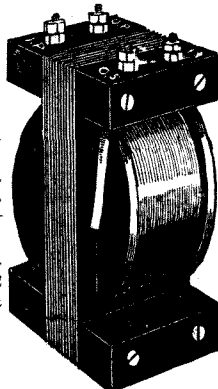

LIST 3d.
POST FREE.

*Phone 323.

TRANSFORMER.

FIT THIS TO YOUR SET AND GET THE BEST RESULTS.

SPECIALLY RECOMMENDED FOR THE S.T. 100 CIRCUIT

PRI. 3 500 TURNS. SEC. 12 000 MACHINE WOUND. Tested and Guaranteed.

PRICE 17/6

POSTAGE 6d. Money returned if not satisfied.

The B&A. Wireless Co.
Verulam St. St. Albans.

FREE HEADPHONE PADS

UNIQUE OFFER

You have probably noticed after 'listening-in' for a short time your headphones commence to hurt your ears owing to the hard surface.

The proprietors of

**WRIGHT'S
COAL TAR
SOAP**

will be pleased to send a pair of headphone pads, specially made of very soft rubber as illustrated

FREE OF CHARGE to any 'listener-in' who sends 6 outside wrappers from tablets of Wright's Coal Tar Soap. Only one pair can be sent to any one applicant owing to the limited number.

Address: "Phone Pads," Wright, Layman & Umney, Ltd., 44/50 Southwark St., London, S.E. 1

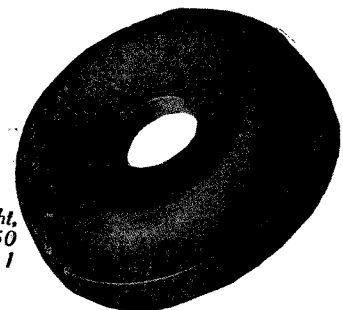

Index to Advertisers

| PAGE | | PAGE | | PAGE | |
|---|---------|---|-------------------|---|----------|
| American Hard Rubber Co., Ltd. | xxxvii | Fellows Magneto Co., Ltd. (Facing matter) | xv | Radio Components Ltd. | xxvii |
| B. & A. Wireless Co. | xxxix | Formo Co. | xxxvi | Radio Equipment Co. | xxxvi |
| Boys (P. H.) & Co., Ltd. | xxxix | Gambrell Bros., Ltd. | xxxiii | Radio Instruments, Ltd. | Cover iv |
| British Battery Co., Ltd. (The) | xxxvi | General Electric Co., Ltd. (Facing matter) | ix, xvi | Raymond (M.) | vii |
| Brown (S. G.), Ltd. | xxi | General Radio Co. (Facing matter) | xi | Robinson, Lionel & Co. | v |
| British L.M. Ericsson Mfg. Co. Ltd. | xxxv | Graham (A.) & Co. | xxvi | Sterling Telephone and Electric Co., Ltd. | v |
| Burndep, Ltd. | iv | Hunt (A. H.) Ltd. | xxvii | Thames Electrical Co. | xxxix |
| Burne-Jones, Ltd. | xx | Igranie Electric Co., Ltd. | xxxvii | Tingey Wireless, Ltd. (Facing matter) | xvii |
| Canadian-Brandes, Ltd. (Facing matter) | xii | Jackson Bros. | xxxv | Turnock's Telephone Works | xxxii |
| Cossor Valve Co. | vi | Lissen Co. | iii | Universal Electric Co., Ltd. | xxxvi |
| Directory of Suppliers | xix, xx | Marconi Wireless Telegraph Co., Ltd. | xxxvii | Ward & Goldstone, Ltd. | xxxiii |
| Drummond Bros. | v | Mullard Radio Valve Co., Ltd. (Facing matter) | xiii | Western Electric Co., Ltd. | Cover ii |
| Dubilier Condenser Co. (1921), Ltd. (Facing matter) | xv | Negretti & Zambra | xxxv | Weston Electrical Instrument Co., Ltd. | xxxvii |
| Economic Assemblies | xxxix | Norwell's Perth Footwear, Ltd. | xxxix | Wilkinson Motor Co. | xx |
| Economic Electric Ltd. | xl | Peto-Scott Co., Ltd. (The) (Facing matter) | xxvii | Woodhall Wireless Mfg. Co. | xxv |
| Edison Swan Electric Co., Ltd. | xxv | Radio Communication Co., Ltd. | xxii, xxiii, xxiv | Wright, Layman & Umney, Ltd. | xxxix |
| Elwell, Ltd. (C. F.) (Facing matter) | xiv | | | | |
| Fallon Condenser Co. | xxxii | | | | |

USE THIS COUPON

CUT HERE

In connection with your announcement in MODERN WIRELESS, please supply me with :

Enclosed please find remittance of.....
(Leave blank if not an order)

If an open envelope is used in applying for catalogues a half-penny stamp will cover postage.

Name.....

Address.....

Date.....

COUPON

Questions and Answers

"MODERN WIRELESS

August, 1923.

ECONOMIC ELECTRIC LTD.

INDUCTIVELY COUPLED TUNER



This is unquestionably the finest "loose coupler" on the market, both in construction and efficiency. The primary coil is wound with enamelled wire operated by a sliding contact and the secondary has double silk wire with a seven point rotary switch. Ends of coils matt finished ebonite; base polished mahogany. Overall dimensions 17½" x 6" x 7", Wavelength range up to 1,500 metres.

Price 50/-



OUR 40-PAGE RADIO BOOK
with over 250 illustrations of everything for the Radio Recruit or Research worker, mailed post free for 4d.

"Xtraudion"

THREE ELECTRODE VALVE

Filament consumption 0.4 amps. at 4 volts; Anode potential 30—75 volts.

PRICE 15/-



Head Office: 10, FITZROY SQUARE, LONDON, W.1. Showrooms: 303, EUSTON RD., N.W.1. Branch Works: TWICKENHAM



Radio Press Books give him all the information he needs

Complete List

| | Post Price. free. | |
|---|-------------------|------------------|
| 1. Wireless for All... John Scott-Taggart, F.Inst.P. | 1/6 | 1/7½ |
| 2. Simplified Wireless... John Scott-Taggart, F.Inst.P. | 1/- | 1/1½ |
| 3. How to Make Your Broadcast Receiver... John Scott-Taggart, F.Inst.P. | 1/6 | 1/7½ |
| 4. How to Erect Your Wireless Aerial... B. Mittell, A.M.I.E.E. | 1/- | 1/1½ |
| 5. The Construction of Wireless Receiving Apparatus... P. D. Tyers | 1/6 | 1/7½ |
| 7. How to Make a "Unit" Wireless Receiver... E. Redpath. | 2/6 | 2/8 |
| 9. Wireless Valves Simply Explained... John Scott-Taggart, F.Inst.P. | 2/6 | 2/8 |
| 10. Practical Wireless Valve Circuits... John Scott-Taggart, F.Inst.P. | 2/6 | 2/8 |
| 11. Wireless Licences and How to Obtain Them... E. Redpath. | 1/- | 1/1½ |
| Elementary Text-book on Wireless Vacuum Tubes... John Scott-Taggart, F.Inst.P. | | 10/- (Post free) |

☐ Those printed in heavy type have been published recently.

HOW many turns for a Coil to reach the Paris Wavelength—the type of circuit to operate a Loud speaker using only an indoor Aerial—Crystal or Valve rectification in a multi-valve Set? These are a few of the questions which confront the amateur constructor.

Some will find out the correct answers by expensive experiment—others, more wisely, will benefit by the experience of those who have trodden the thorny paths of Radio before them.

The concentrated experience of some of the best known Wireless engineers and experimenters is available for all readers of Radio Press Books. You cannot do better than purchase the complete Library—one Book at a time. Each Book covers a different phase of Wireless and none overlap. Get one or two to-day and keep them by you for ready reference—they are sure to save their cost many times over. From all Booksellers.

RADIO PRESS LTD.,
Devereux Court, STRAND, W.C.2.

Radio Press Books
— a complete Wireless Library



**NEW (R.I. 5) PORTABLE
VALVE RECEIVER.**

Wave length range 300 to 4,000 metres.



A powerful selective 5-valve Amplifying Receiver comprising 1 H.F. stage with Variable intervalve reaction, 1 Detector and 3 L.F. valves (fitted with the Famous **R.I.** Transformers). The instrument is mounted in a handsome mahogany cabinet with carrying handles as illustrated.

This set is simple to control notwithstanding it is the most efficient 5-valve Broadcast instrument yet placed on the market.

R.I. Ltd. make no claim that cannot be fully substantiated.

A special plug device for cutting out valves giving four combinations is included.

Price £38 : 0 : 0

All accessories, including 120 volt H.T. Battery and valves.

Price £10 : 0 : 0

Radio Hints.

3.—Loose or imperfect contact between each terminal of the accumulator and the lugs or leads will cause frying or crackling sounds in the phones. Clean and tighten up periodically.

RADIO INSTRUMENTS LTD.

Managing Director: J. JOSEPH, M.I.E.E.

Chief Designer: W. A. APPLETON, M.B.E., M.I.R.E., late Admiralty Technical Research Officer.

Works, Offices and Showrooms:

12, Hyde Street, NEW OXFORD STREET, W.C. 1.

Telephone: REGENT, 6214-5-6.

Northern Depots: 19, Hopwood Avenue, MANCHESTER

Telegrams: "INSTRADIO, LONDON."

Trinity House, Commercial Street, LEFDS
(E P 8 67)